



Hilti – registered trademark of Hilti Corp., Schaun | W3479 0516 0-en | 1 Printed in Germany | © 2015 | Right of technical and programme changes reserved. S. E. & O.



Direct Fastening Technology
Manual 2015



Contents

Hilti Direct Fastening System

Part 1: Fastener selection guide		
Fastener selection guide		6
Nails and Stud designation		12
Part 2: Trade application guide		A
Steel and Metal		16
Petrochemical, Power, Mining, Shipbuilding, Industrial		24
Mechanical and Electrical		32
Building Construction		40
Interior Finishing		50
Wood Framing		54
Part 3: DX & GX tools and equipment		B
DX 460	General Purpose Tool	61
DX 351		65
DX E72		67
DX 36, DX 2		68
DX 76 PTR		69
DX 76		72
DX-860	Tool for Decking	75
Cartridges		76
GX 90 WF		77
GX 100, GX 100-E	Gas Tool for Interior Finishing and for Electrical Applications	78
GX 120, GX 120-ME	Gas Tool for Interior Finishing and for Electrical Applications	79
Tips for users ("Trouble Shooting")		80
Part 4: DX and GX fasteners		
Siding and Decking Nails		C
X-ENP	Siding and Decking Nail	87
SDK2, PDK2	Sealing Caps for Cladding Fastening	95
ENP2K	Siding and Decking Nail	97
X-HSN 24, X-EDNK 22 THQ12, X-EDN19 THQ12	Diaphragm Decking Nails	103
NPH	Siding and Decking Nails to Concrete	107

Shear Connectors		C
X-HVB	Shear Connectors	111
General Purpose Nails		D
X-U	General Purpose Nails for Concrete and Steel	119
X-C	Nails for Concrete and Sand-lime Masonry	129
X-S	Drywall Fasteners to Steel	135
X-EGN, X-GHP, X-GN	GX Fasteners	139
DS	Heavy Duty General Purpose Nails for Concrete and Steel	145
EDS	Nails for Fastening Steel to Steel	151
Application Specific Nails		E
X-CR	Stainless Steel Nails for Fastening to Steel	157
X-CR	Stainless Steel Nails for Concrete, Sand-lime Masonry and Steel	161
X-CT	Nails for Forming or other temporary uses	167
DNH, X-DKH	DX-Kwik Nails	171
Threaded Studs		F
X-M6H, X-M8H	DX-Kwik Threaded Studs	171
X-M6, X-W6, X-M8, M10 / W10	Threaded Studs for Concrete	177
X-EM6H/EW6H, X-EF7H, X-EM8H, X-EM10H/EW10H	Threaded Studs for Steel	181
X-BT	Stainless Steel Threaded Studs	187
X-CR M	Stainless Steel Threaded Studs for Concrete and Steel	195
Grating and Plate Fastening System		F
X-FCM	Grating Fastening System	201
X-GR	Grating Fastening System	209
X-PGR-RU	Grating Fastening System (Pre-drilled)	213
X-MGR	Grating Fastening System	217
X-FCP	Checker Plate Fastening System	221
Fasteners for insulation soft material and formwork		G
X-IE	Wall Insulation Fastener	227
X-SW	Soft Washer Fastener	231
X-FS	Form Stop	235

Hanger fasteners		G
X-HS, X-CC	Threaded Hanger and Loop Hanger Systems	237
X-EHS MX, X-ECC MX	Electrical Hanger Systems	243
X-HS-W	Wire Hanging System	247
Electrical fasteners		G
X-EKB, X-ECH	Electrical Cable Fasteners	251
X-FB, (X-DFB/X-EMTC)	Electrical Conduit Fasteners	257
X-ECT MX, X-UCT MX, X-EKS MX	Electrical Cable Tie, Conduit Clip Fastener	261
X-ET	Fastening Plastic Electrical Cable Trays and Junction Boxes	265
Wood Nails		H
GX-WF	Wood Framing Nails	269
Part 5: Direct fastening principles and technique		
1. Introduction		281
1.1 Definitions and general terminology		281
1.2 Reasons for using powder or gas-actuated fastening		281
1.3 Direct fastening applications		283
2. The direct fastening system		286
2.1 Fasteners		287
2.2 Manufacturing process		288
2.3 Fastener raw material		289
2.4 Powder- and gas-actuated tools		290
2.5 Cartridges (powder loads, boosters)		292
3. Health and safety		294
3.1 Operator safety		294
3.2 Fastening safety		298
3.3 Functional safety		300
3.4 DX Cartridge safety		301
3.5 DX Tools safety		301
4. Corrosion		302
4.1 Corrosion protection of direct fastening systems		302
4.2 Fastener selection		304

5. Steel base material	308
5.1 Anchoring mechanisms	308
5.2 Factors influencing pull-out resistance	310
5.3 Suitability of the steel for fastening	315
5.4 Application limit diagrams	316
5.5 Thin steel base material	317
5.6 Types of load and modes of failure	318
5.7 Effect of fasteners on structural steel	325
6. Concrete base material	330
6.1 Anchoring mechanisms	330
6.2 Factors influencing the resistance to pull-out	332
6.3 Effect of time on pull-out resistance	335
6.4 Effect on concrete components	336
7. Masonry base material	337
7.1 General suitability	337
8. Temperature effects on the fastening	338
8.1 Effect of low temperature on fasteners	338
8.2 Effect of low temperatures on fastenings to steel	339
8.3 Fire rating of fastenings to steel	341
8.4 Fire rating of fastenings to concrete	343
9. Design concepts	345
10. Determination of technical data for fastening design	347
10.1 Fastenings to steel	347
10.2 Profiled sheet fastenings	348
10.3 Fastenings to concrete (standard DX / GX)	349
10.4 DX fastenings to concrete (DX-Kwik)	351
10.5 Fastener design in the USA and Canada	352

Summary of Approvals - Direct Fastening

Approvals → Nails	353
Nails → Approvals	356

Alphabetical List of DX and GX Fasteners

362

Part 1:**Fastener selection guide**

Fastener selection guide

Selecting the right fastener

There are six fastener selection charts corresponding to six trade groups:

- Steel metal (e.g. siding and decking, cladding, grating)
- Petrochemical and industrial (e.g. installations, off-shore)
- Interior finishing (e.g. drywall, suspended ceilings)
- General construction (e.g. concrete forming, insulation)
- HVAC, plumbing and electrical
- Wood framing

To find a DX- or GX fastener for an application, enter the appropriate trade group chart with the application:



Detailed technical information for the selected fastener family is found on its product information sheet.

For some applications, two or more fastener families are listed as suitable. The final selection is influenced by technical data found on the product sheets.

Regional differences in building methods, materials, trade preferences, available tools, etc. also influence fastener selection. Therefore, designers and specifiers are advised to consult the current Hilti catalogue and make use of the local Hilti technical advisory service.

Corrosion

Corrosion has a major influence on the suitability of a fastener and therefore also on fastener selection. In order to provide a basis for judging the suitability of fasteners, it is useful to categorise applications in three classes:

- Safety relevant, permanent applications: (e.g. profiled metal sheet fastenings in roofs and walls)
- Non-safety relevant, permanent fastenings (e.g. metal track fastenings for drywall)
- Non-safety relevant, temporary fastenings (e.g. fastenings of wooden sills, kickers, etc. in concrete forming).

For **non-safety-relevant applications**, zinc-plated fasteners made of normal carbon steel can be used without restriction.

For **safety-relevant, permanent fastenings** the restrictions described below apply:

- In any case there is a restriction to the use of galvanized carbon steel fasteners if they are exposed to weather or if they are inside and subject to repeated wetting as from condensation. The galvanization (typically in a range from 5 to 20 microns of Zn) provides corrosion protection during transport and construction, during which exposure to weather can never be completely prevented. If the fastenings are exposed to repeated wetting or weather during their service life, the use of galvanized carbon steel fasteners is prohibited and stainless steel fasteners must be used. This safety measure must be observed without exception because the corrosion of galvanized steel fasteners leads not just to material loss but also to hydrogen embrittlement. Hydrogen embrittlement can easily result in fracture of the fastener at very low load.
- Referring to the above-mentioned example of profiled metal sheet fastening for roofs and walls, the use of galvanized steel fasteners is allowable only where wetting of the fastener is not to be expected. This applies in general to inside skins of two skin, insulated roofs and walls enclosing dry and closed rooms. This is the classic application area for X-ENP 19 galvanized fasteners.

Contact corrosion is taken into consideration by observing common rules concerning acceptable material combinations. Parts made of less noble metals are subject to increased corrosion if they are in electrochemical contact with a larger part made of a more noble metal, provided of course that an electrolyte is present. Fasteners that are used in wet areas must be at least as noble or better, nobler than the fastened part. The effect of contact corrosion is shown in the table below. This information is especially applicable to stainless steel X-CR fasteners because only the X-CR is suitable for safety-relevant, permanent application in outdoor areas or areas otherwise exposed to corrosion.

Fastened part	Powder- and gas-actuated fastener:	
	Zinc-plated carbon steel	X-CR stainless steel
Construction steel (uncoated)	○	○
Galvanized steel sheet	○	○
Aluminum alloy	●	○
Stainless steel sheet	●	○

○ Negligible or no corrosion of fastener
● Heavy corrosion of fastener

The accelerated corrosion of a fastener due to contact corrosion can take place only in the presence of an electrolyte (moisture from precipitation or condensation). Without this electrolyte – e.g. in dry inside rooms – zinc-plated fasteners can be used in connection with more noble metals.

Design concepts

The recommended working loads (N_{rec} and V_{rec}) are suitable for use in typical working load designs. If a partial safety factor design method is to be used, the N_{rec} and V_{rec} values are conservative when used as N_{Rd} and V_{Rd} . Exact values for N_{Rd} and V_{Rd} can be determined by using the safety factors where given and/or by reviewing test data. Design loads (characteristic strength, design resistance and working loads) for the **X-HVB** shear connector are listed and ordered as per design guideline.

Worldwide the designer may encounter two main fastening design concepts:

Working load concept

$$N_S \leq N_{\text{rec}} = \frac{N_{\text{Rk}}}{\gamma_{\text{GLOB}}}$$

where γ_{GLOB} is an overall factor of safety including allowance for:

- errors in estimation of load
- deviations in material and workmanship

and N_S is, in general a characteristic acting load.

$$N_S \approx N_{\text{Sk}}$$

Partial factors of safety

$$N_{\text{Sk}} \cdot \gamma_{\text{F}} = N_{\text{Sd}} \leq \frac{N_{\text{Rk}}}{\gamma_{\text{M}}} = N_{\text{Rd}}$$

where:

γ_{F} is a partial factor of safety to allow for errors in estimation on the acting load.

γ_{M} is a partial factor of safety to allow for deviations in material and workmanship.

Structural analysis of the fastened part (e.g. roof deck panel or pipe hung from a number of fastenings) leads to calculation of the load acting on a single fastening, which is then compared to the recommended load (or design value of the resistance) for the fastener. In spite of this single point design concept, it is necessary to ensure that there is sufficient redundancy that the failure of a single fastening will not lead to collapse of the entire system. The old saying “one bolt is no bolt” applies also to DX and GX fastening.

Nomenclature / symbols

Following is a table of symbols and nomenclature used in the technical data.

Fastener test data and performance	
N and V	Tensile and shear forces in a general sense
F	Combined force (resulting from N and V) in a general sense
N_S and V_S	Tensile and shear forces acting on a fastening in a design calculation
F_S	Combined force (resulting from N_S and V_S) in a design calculation
N_u and V_u	Ultimate tensile and shear forces that cause failure of the fastening; statistically, the reading for one specimen
N_{u,m} and V_{u,m}	Average ultimate tensile and shear forces that cause failure of the fastening, statistically, the average for a sample of several specimens
S	The standard deviation of the sample
N_{test,k} and V_{test,k}	Characteristic tensile and shear resistance of test data, statistically, the 5 % fractile.
N_{Rk} and V_{Rk}	Characteristic tensile and shear resistance of the fastening used for fastening design; statistically, the 5 % fractile. For example the characteristic strength of a fastening whose ultimate strength can be described by a standard Gauss type distribution is calculated by: N_{Rk} = N_{u,m} - k · S where k is a function of the sample size, n and the desired confidence interval.
N_{Rd} and V_{Rd}	Tensile and shear design force on the fastener shank $N_{Rd} = \frac{N_{Rk}}{\gamma_M} \text{ and } V_{Rd} = \frac{V_{Rk}}{\gamma_M}$ where γ_M is a partial safety factor for the resistance of the fastening
N_{rec} and V_{rec}	Recommended tensile and shear force on the fastener shank $N_{rec} = \frac{N_{Rk}}{\gamma_{GLOB}} \text{ and } V_{rec} = \frac{V_{Rk}}{\gamma_{GLOB}}$ where γ_{GLOB} is an overall factor of safety
M_{rec}	Recommended working moment on the fastener shank $M_{rec} = \frac{M_{Rk}}{\gamma_{GLOB}}$ where M_{Rk} is the characteristic moment resistance of the fastener shank and γ_{GLOB} is an overall factor of safety. Unless otherwise stated on the product data sheets, the M_{rec} values in this manual include a safety factor of "2" for static loading.

Fastening details

h_{ET}

Penetration of the fastener point below the surface of the base material

h_{NVS} Nail head standoff above the surface fastened into (with nails, this is the surface of the fastened material, with threaded studs, the surface of the base material).

t_{II} Thickness of the base material

t_I Thickness of the fastened material

Σt_I Total thickness of the fastened material (where more than one layer is fastened)

Characteristics of steel and other metals

f_y and f_u Yield strength and ultimate tensile strength of metals (in N/mm² or MPa)

Characteristics of concrete and masonry

f_c Compressive strength of cylinder (150 mm diameter, 300 mm height)

f_{cc} Compressive strength of cube (150 mm edge length)

$f_{c,100} / f_{cc,200}$ Compressive strength of 100 mm diameter cylinder / cube with 200 mm edge length

In some cases building material grades are used to describe the suitable range of application. Examples of European concrete grades are C20/25, C30/35, C50/55.

Approvals, technical assessments and design guidelines are given on the product information sheets as abbreviations of the names of the issuing institutes or agencies. Following is a list of abbreviations:

Abbreviation	Name of institute or agency / description	Country
FM	Factory Mutual (insurers' technical service)	USA
UL	Underwriters Laboratories (insurers' technical service)	USA
ICC	International Code Council	USA
SDI	Steel Deck Institute (technical trade association)	USA
CSTB	Centre Scientifique et Technique du Bâtiment (approval agency)	France
DIBt	Deutsche Institute für Bautechnik (approval agency)	Germany
SOCOTEC	SOCOTEC (insurers' technical service)	France
ÖNORM	Österreichische Norm / Austrian National Standard	Austria
SCI	Steel Construction Institute	Great Britain

ABS	American Bureau of Shipping (international classification society for ship and marine structures)
LR	Lloyd's Register (international classification society for ship and marine structures)
GL	Germanischer Lloyd (international classification society for ship and marine structures)
DNV	Det Norske Veritas (international classification society for the marine and energy industry)

Nail designation

		X-C	32	P8 S23 T
Application:		Washer type Ø (in mm):		
X-ENP	Siding and Decking Nails	P Plastic washer e.g. P8 = plastic washer Ø 8		
X-ENP2K		S Steel washer e.g. S36 = steel washer Ø 36		
X-EDNK22	Diaphragm Decking Nails	D Two washers		
X-EDN19		L Two domed washers		
NPH	Siding and Decking Nails to Concrete	TH Top Hat		
X-U	Universal Nails	THQ Top Hat and high shear washer		
X-C	Nails for Concrete and Sand lime-Masonry	MX Collated for DX tool/ composite fasteners for GX tool		
X-S	Drywall Fasteners to Steel	MXR Collated for DX 860-ENP		
X-EGN	Gas Nails	T For tunneling applications		
X-GHP				
X-GN				
DS	Heavy Duty Nails for Concrete and Steel			
EDS	Heavy Duty Nails for Fastening Steel to Steel			
X-CR	Stainless Steel Nails for Concrete, Sand lime Masonry and Steel. And Steel only.			
X-CT	Nails for Forming or other Temporary uses			
DNH	DX-Kwik Nails for Concrete			
X-DKH	(pre-drilled)			
		Dimensions:		
		Length in mm (For details, please refer to product data)		

Examples:

X-U 52 P8

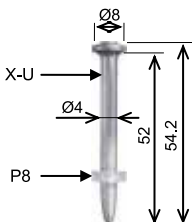

X-U 52 MX

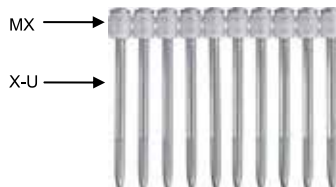

Threaded stud designation

		X-M6H	10-37	FP8
Application:		DX-Kwik Threaded Studs for Concrete (pre-drilled) Threaded Studs for Concrete Threaded Studs for Steel Stainless Steel Threaded Studs Stainless Steel Threaded Studs for Concrete and Steel		Washer type and Ø (in mm): P Plastic washer e.g. P8 = plastic washer Ø 8 S Steel washer e.g. S8 = steel washer Ø 8 D Two washers F Plastic guidance sleeve SN12-R Stainless steel washer for sealing purposes
				Dimensions: Thread Length and Shank Length in mm

where M, W, F refer to the thread type:

M	Metric
W	Whitworth
F	French

Examples:

X-BT W10-24-6 SN12-R

X-BT M10-24-6 SN12-R

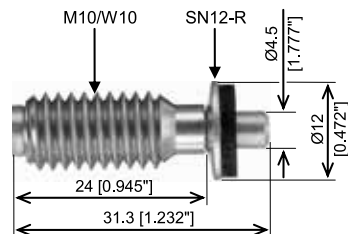

Wood nail designation

GX - WF 51x2.8 (R) (D) 34 (HDG)

Technology:

GX | Gas driven

Profile:

R | Profiled
() | Non Profiled

Application:

WF | Wood Framing

Head shape:

D | D-Head Shape
() | Round Head Shape

Dimensions

Length and Nail Diameter in mm

Collation:

34 | 34° Collation
() | Round Head Shape

Designation of corrosion protection on the box/label

Suffix	Type of protection	Service Class (EN 1995-1-1)
"Bright"	no coating	1
"Galv"	12 µm zinc	1, 2
"HDG"	55 µm hot dip galvanized	1, 2, 3
"Stainless"	A2 or A4	1, 2, 3

Part 2:**Trade application guide**

Steel and metal

Technology	Base material					Fastener
	Green / fresh concrete	Concrete	Old / high strength concrete	Steel ≥ 3 mm, bar joist, inlays	Steel ≥ 6 mm, beams	

Roof decking: double skin and flat roof insulated



Technology	Base material					Fastener
	Green / fresh concrete	Concrete	Old / high strength concrete	Steel ≥ 3 mm, bar joist, inlays	Steel ≥ 6 mm, beams	
DX					●	X-ENP
				●		X-EDN19
				●		X-EDNK22
				●		X-ENP2K
	●	●	●			NPH2

Fastener	Description	Approvals	Page
----------	-------------	-----------	------

	Standard decking pin for structural steel ≥ 6 mm	●	87
	Decking pin for 5–10 mm ($3/16$ "– $3/8$ ") bar joist or steel construction / diaphragm design (USA)	●	103
	Decking pin for 3–6 mm ($1/8$ "– $1/4$ ") bar joist or steel construction / diaphragm design (USA)	●	103
	Decking pin for 3–6 mm base material	●	103
	Fastening with pre-drilling	●	107

Steel and metal

Technology	Base material					Fastener
	Green / fresh concrete	Concrete	Old / high strength concrete	Steel \geq 3 mm, bar joist, inlays	Steel \geq 6 mm, beams	

Roof decking: single skin non insulated



DX					●	X-ENP
----	--	--	--	--	---	-------



Application on the wall: double skin insulated



DX					●	X-ENP
				●		X-ENP2K
	●	●	●			NPH2

Fastener	Description	Approvals	Page
----------	-------------	-----------	------

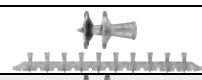
	Standard decking pin for structural steel \geq 6 mm, X-ENP with SDK2 ceiling cap	●	87
---	--	---	----

	Standard decking pin for structural steel \geq 6 mm	●	87
	Decking pin for 3–6 mm base material	●	97
	Fastening with pre-drilling	●	107

Steel and metal

Technology	Base material					Fastener
	Green / fresh concrete	Concrete	Old / high strength concrete	Steel ≥ 3 mm, bar joist, inlays	Steel ≥ 6 mm, beams	
					●	X-ENP

Application on the wall: Single skin non insulated



DX					●	X-ENP
----	--	--	--	--	---	-------

Composite floor decking: with shear connectors



DX					●	X-HVB + X-ENP-21 HVB
----	--	--	--	--	---	----------------------

Fastener	Description	Approvals	Page
	Standard decking pin for structural steel ≥ 6 mm, with SDK2 or PDK2 sealing cap	●	87

	Shear connector with X-ENP nail	●	111
---	---------------------------------	---	-----

	Shear connector with X-ENP nail	●	111
---	---------------------------------	---	-----

Steel and metal

Technology	Base material					Fastener
	Green / fresh concrete	Concrete	Old / high strength concrete	Steel \geq 3 mm, bar joist, inlays	Steel \geq 6 mm, beams	

Tacking of composite decks



DX						
					●	X-ENP
				●		X-EDN19
				●		X-EDNK22
				●		X-ENP2K
					●	X-U15

Fastening metal brackets, clips, metal tracks, etc. to steel



DX						
					●	X-U
					●	EDS
					●	X-CR
					●	X-EM_H
					●	X-BT
				●	X-CRM	

Fastener	Description	Approvals	Page
----------	-------------	-----------	------

	Standard decking pin for structural steel \geq 6 mm ($3/16''$ – $3/8''$)	●	87
	Decking pin for 5–10 mm ($3/16''$ – $3/8''$) bar joist or steel construction / diaphragm design (USA)	●	103
	Decking pin for 3–6 mm ($3/16''$ – $3/8''$) bar joist or steel construction / diaphragm design (USA)	●	103
	Decking pin for 3–6 mm base material	●	97
	Step shank fastener	●	119
	Pin length: 16–22 mm, 4 mm shank diameter	●	119
	Pin length: 22–27 mm, 4.5 mm shank diameter	●	151
	Outdoor applications, corrosion-resistant fastener required; pin length: 14–22 mm, 3.7 mm shank dia.	●	157
	Threaded connection	●	181
	Threaded connection, corrosion-resistant fastener required, through penetration of base steel not permitted	●	187
	Threaded connection, corrosion-resistant fastener required	●	195

Petrochemical, Power, Mining, Shipbuilding, Industrial

Technology	Base material						Fastener
	Green / fresh concrete	Concrete	Old / high strength concrete	Steel < 3 mm, profiles, inlays HTU	Steel ≥ 3 mm, bar joist	Steel ≥ 6 mm, beams	

Metal / fiberglass grating to steel for upstream and high corrosive environment





DX						●	X-BT M8
							X-FCM-R





Metal / fiberglass grating to steel for downstream / Industrial applications and medium corrosive



DX						●	X-CR M8
							X-FCM-M
						●	X-GR
						●	X-PGR-RU
					●	●	X-MGR

Fastener	Description	Approvals	Page
----------	-------------	-----------	------

	Stainless steel stud for "hot for through-penetration"; steel thickness ≥ 8 mm, coated and uncoated steel, high strength steel	●	187
	Stainless steel grating disc	●	201

	Stainless steel stud	●	195
	Grating disc, hot dip galvanized	●	201
	Removable grating fastener		209
	Removable grating fastener		213
	Removable grating fastener		217

Petrochemical, Power, Mining, Shipbuilding, Industrial

Technology	Base material					Fastener
	Green / fresh concrete	Concrete	Old / high strength concrete	Steel \geq 3 mm, bar joist	Steel \geq 6 mm, beams	

Fastening steel plate (chequerplate) 5–13 mm to steel / high corrosive resistance





DX						Fastener	
							●
							X-FCP-R



Fastening steel plate (chequerplate) 5–13 mm to steel / medium corrosive resistance



DX						Fastener	
							●
							X-FCP-F

Fastener	Description	Approvals	Page
----------	-------------	-----------	------

	Stainless steel stud	●	195
	Stainless steel disc	●	221

	Stainless steel stud	●	195
	Disc duplex coated	●	221

Petrochemical, Power, Mining, Shipbuilding, Industrial

Technology	Base material					Fastener
	Green / fresh concrete	Concrete	Old / high strength concrete	Steel ≥ 3 mm, bar joist	Steel ≥ 6 mm, beams	

Mechanical and electrical for petro chemical industry, shipbuilding, etc.



Technology	Base material					Fastener
	Green / fresh concrete	Concrete	Old / high strength concrete	Steel ≥ 3 mm, bar joist	Steel ≥ 6 mm, beams	
DX					●	X-BT M10 X-BT W10
					●	X-BT M6 X-BT W6

Electrical connections



Technology	Base material					Fastener
	Green / fresh concrete	Concrete	Old / high strength concrete	Steel ≥ 3 mm, bar joist	Steel ≥ 6 mm, beams	
DX					●	X-BT-ER M10 X-BT-ER W10
					●	X-BT-ER M8
					●	X-BT-ER M6 X-BT-ER W6

Fastener	Description	Approvals	Page
----------	-------------	-----------	------

	Stainless steel stud for "not for through-penetration"; steel thickness ≥ 8 mm, coated and uncoated steel, high strength steel	●	187
	Stainless steel stud for "not for through-penetration"; steel thickness ≥ 8 mm, coated and uncoated steel, high strength steel	●	187

	Stainless steel electrical connector for bonding steel elements and discharging current to steel, min thickness of base material ≥ 8 mm, coated and uncoated steel, high strength steel, suitable for <u>single connections</u>	●	Available in separate documents
	Stainless steel electrical connector for bonding steel elements and discharging current to steel, min thickness of base material ≥ 8 mm, coated and uncoated steel, high strength steel, suitable for <u>single and double connections</u>	●	
		●	

**Petrochemical,
Power, Mining,
Shipbuilding,
Industrial**

Technology	Base material					Fastener
	Green / fresh concrete	Concrete	Old / high strength concrete	Steel \geq 3 mm, bar joist	Steel \geq 6 mm, beams	

Tagging



DX						
				●		X-U15

Fastener	Description	Approvals	Page



Step shank fastener	●	119
---------------------	---	-----

Mechanical and electrical

Technology	Base material						Fastener
	Green / fresh concrete	Concrete	Old / high strength concrete	Steel > 3 mm, bar joist	Steel ≥ 6 mm, beams	Sand-lime stone, masonry	

Plastic / flexible conduit and metal conduits



DX/GX	DX/GX	●	●	●	●	●	●	X-FB MX
	DX	●	●		●	●		X-FB
	DX/GX	●	●	●	●	●	●	X-DFB MX
	DX	●	●		●	●		X-DFB
DX / GX		●	●	●	●	●	●	X-EKS MX
		●	●	●	●	●	●	X-EKSC MX
		●	●	●	●	●	●	X-ECT MX



Metal pipes



DX		●	●	●				X-M6 X-M8 M10
		●	●	●				X-W6 W10
					●	●		X-EM6H X-EM8H X-EM10H
					●	●		X-EW6H X-EW10H
		●	●	●				X-M6H X-M8H

Fastener	Description	Approvals	Page
----------	-------------	-----------	------

	Single conduit fastener collated for 16–40 mm diameter	●	257
	Single conduit fastener premounted for 16–50 mm diameter		257
	Double conduit fastener collated for 16–40 mm diameter		257
	Double conduit fastener premounted for 16–40 mm diameter		257
	Conduit clips for 16–40 mm diameter		261
	Conduit clips for 16–40 mm diameter		261
	To use with cable tie		261

	Metric threaded studs for use with pipe ring		177
	Whitworth threaded studs for use with pipe ring	●	177
	Metric threaded studs for use with pipe ring	●	181
	Whitworth threaded studs for use with pipe ring	●	181
	DX-Kwik threaded studs for use with pipe ring	●	181

Mechanical and electrical

Technology	Base material						Fastener
	Green / fresh concrete	Concrete	Old / high strength concrete	Steel > 3 mm, bar joist	Steel ≥ 6 mm, beams	Sand-lime stone, masonry	

Electrical cables



Technology	DX/GX	Base material						Fastener
		Green / fresh concrete	Concrete	Old / high strength concrete	Steel > 3 mm, bar joist	Steel ≥ 6 mm, beams	Sand-lime stone, masonry	
DX	DX/GX	●	●	●	●	●	●	X-EKB MX
		●	●	●	●	●		X-EKB
		●	●		●	●		X-ECH
		●	●	●	●	●	●	X-ECH MX

Trunking

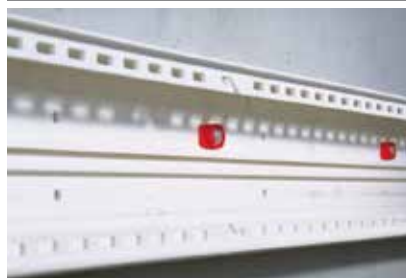

Technology	DX/GX	Base material						Fastener
		Green / fresh concrete	Concrete	Old / high strength concrete	Steel > 3 mm, bar joist	Steel ≥ 6 mm, beams	Sand-lime stone, masonry	
DX	DX/GX	●	●	●	●	●	●	X-ET MX
		●	●					X-ET UK

Fastener	Description	Approvals	Page
----------	-------------	-----------	------

	Electrical cable tie, collated version	●	251
	Electrical cable tie, premounted version		251
	Electrical cable tie, premounted version	●	251
	Electrical cable tie, premounted version		251

			265
	Fasteners for electrical cable trays and junction boxes, premounted version		265

Mechanical and electrical

Technology	Base material						Fastener
	Green / fresh concrete	Concrete	Old / high strength concrete	Steel ≥ 3 mm, bar joist	Steel ≥ 6 mm, beams	Sand-lime stone, masonry	

Junction boxes



DX/GX							
	●	●	●	●	●	●	X-ET MX





Cable trays



DX							
	●	●	●		●		X-HS
	●	●	●	●	●	●	X-EHS MX
	●	●	●	●	●		X-HS-W
				●	●		X-EM6H X-EM8H X-EM10H
	●	●	●				X-M6 X-M8 M10

Fastener	Description	Approvals	Page
----------	-------------	-----------	------

	Fasteners for electrical cable trays and junction boxes, collated version		265
---	---	--	-----

			237
	Threaded hanger for light electrical applications		243
	Threaded hanger for light electrical applications		247
	Threaded studs, metric	●	181
	Threaded studs, metric		177

Mechanical and electrical

Technology	Base material						Fastener
	Green / fresh concrete	Concrete	Old / high strength concrete	Steel \geq 3 mm, bar joist	Steel \geq 6 mm, beams	Sand-lime stone, masonry	

Lighting





	DX							Fastener
		Green / fresh concrete	Concrete	Old / high strength concrete	Steel \geq 3 mm, bar joist	Steel \geq 6 mm, beams	Sand-lime stone, masonry	
		●	●	●	●	●		
	DX/GX	●	●	●	●	●	●	X-ECC MX
	DX	●	●	●	●	●		X-HS-W





Air ducts



	DX							Fastener		
		Green / fresh concrete	Concrete	Old / high strength concrete	Steel \geq 3 mm, bar joist	Steel \geq 6 mm, beams	Sand-lime stone, masonry			
						●	●			X-EM8 X-EM10
		●	●	●						X-M8 M10
		●	●	●						W10
		●	●	●						X-HS M6, M8 X-HS W6, W10
●	●	●					X-M6H X-M8H			

Fastener	Description	Approvals	Page
----------	-------------	-----------	------

	Loop hanger		237
	Loop hanger for light electrical applications		243
	Threaded hanger for light electrical applications		247

	Threaded studs, metric	●	181
	Threaded studs, metric		177
	Whitworth threaded studs	●	177
	Threaded hanger		243
	DX-Kwik threaded studs for use with pipe ring	●	177

Building construction

Technology	Base material						Fastener
	Green / fresh concrete	Concrete	Old / high strength concrete	Steel > 3 mm, bar joist	Steel ≥ 6 mm, beams	Sand-lime stone, masonry	

Formwork positioning



DX	●	●	●	●	●		X-U
	●	●	●				X-C
	●						X-CT
							X-FS MX

Safety barriers / generic wood fastenings



DX	●	●	●	●	●		X-U
	●	●	●				X-C

Fastener	Description	Approvals	Page
----------	-------------	-----------	------

	Pin length 22–72 mm, 4 mm shank diameter	●	119
	Pin length 22–72 mm, 3.5 mm shank diameter	●	129
	Temporary, removable, pin length 47–72 mm, 3.7 mm shank diameter		167
	Form stop to use with X-U, X-C		235

	Pin length 22–72 mm, 4 mm shank diameter	●	119
	Pin length 22–72 mm, 3.5 mm shank diameter	●	129

Building construction

Technology	Base material						Fastener
	Green / fresh concrete	Concrete	Old / high strength concrete	Steel \geq 3 mm, bar joist	Steel \geq 6 mm, beams	Sand-lime stone, masonry	

Hardwood flooring





DX							Fastener
	●	●	●	●	●		
	●	●	●				X-C



Wall-tie (Facade wall)



DX							Fastener	
		●	●	●	●			X-U
	●	●	●					X-C
	●			●			X-CR	

Fastener	Description	Approvals	Page
----------	-------------	-----------	------

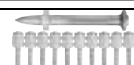
	Pin length 22–72 mm, 4 mm shank diameter	●	119
	Pin length 22–72 mm, 3.5 mm shank diameter	●	129

	Pin length 16–72 mm, 4 mm shank diameter	●	119
	Pin length 14–72 mm, 3.5 mm shank diameter	●	129
	Stainless steel, pin length 14–54 mm, 3.7 mm shank diameter	●	161

Building construction

Technology	Base material						Fastener
	Green / fresh concrete	Concrete	Old / high strength concrete	Steel ≥ 3 mm, bar joist	Steel ≥ 6 mm, beams	Sand-lime stone, masonry	

Wire mesh





DX							Fastener
	●	●	●	●	●	●	
●	●	●	●	●	●	●	X-C



Window and door frames



DX							Fastener
	●	●	●	●	●	●	
●	●	●	●	●	●	●	X-C

Fastener	Description	Approvals	Page
----------	-------------	-----------	------

	Pin length 16–72 mm, 4 mm shank diameter	●	119
	Pin length 14–72 mm, 3.5 mm shank diameter	●	129

	Pin length 16–72 mm, 4 mm shank diameter	●	119
	Pin length 14–72 mm, 3.5 mm shank diameter	●	129

Building construction

Technology	Base material						Fastener
	Green / fresh concrete	Concrete	Old / high strength concrete	Steel ≥ 3 mm, bar joist	Steel ≥ 6 mm, beams	Sand-lime stone, masonry	

Thermal insulation



DX		●					X-IE XI-FV
----	--	---	--	--	--	--	-----------------------

Water drainage membrane



DX		●	●	●	●		X-U
	●	●	●				X-C
		●			●		X-SW

Fastener	Description	Approvals	Page
----------	-------------	-----------	------

	Wall insulation for 25–120 mm thickness		227
--	---	--	-----

	Pin length 22–72 mm, 4 mm shank diameter	●	119
	Pin length 22–72 mm, 3.5 mm shank diameter	●	129
	Soft washer fastener		231

Building construction

Technology	Base material						Fastener
	Green / fresh concrete	Concrete	Old / high strength concrete	Steel ≥ 3 mm, bar joist	Steel ≥ 6 mm, beams	Sand-lime stone, masonry	

Water sealing / swelling strip





DX	Green / fresh concrete	Concrete	Old / high strength concrete	Steel ≥ 3 mm, bar joist	Steel ≥ 6 mm, beams	Sand-lime stone, masonry	Fastener
		●	●	●		●	
	●	●	●				X-C



Water sealing / injection hose



DX	Green / fresh concrete	Concrete	Old / high strength concrete	Steel ≥ 3 mm, bar joist	Steel ≥ 6 mm, beams	Sand-lime stone, masonry	Fastener	
		●	●	●		●		X-U
		●	●	●				X-C
	●	●	●		●		X-FB MX	

Fastener	Description	Approvals	Page
----------	-------------	-----------	------

	Pin length 22–72 mm, 4 mm shank diameter	●	119
	Pin length 22–72 mm, 3.5 mm shank diameter	●	129

	Pin length 22–72 mm, 4 mm shank diameter	●	119
	Pin length 22–72 mm, 3.5 mm shank diameter	●	129
	For fixing pipes, to use with X-U, X-C		257

Interior finishing

Technology	Base material						Fastener
	Green / fresh concrete	Concrete	Old / high strength concrete	Steel \geq 3 mm, bar joist	Steel \geq 6 mm, beams	Sand-lime stone, masonry	

Metal track (hat track)











	DX	Base material						Fastener
		Green / fresh concrete	Concrete	Old / high strength concrete	Steel \geq 3 mm, bar joist	Steel \geq 6 mm, beams	Sand-lime stone, masonry	
		●	●	●	●			X-U
	●	●	●		●			X-C
	GX			●		●		X-GHP
					●	●		X-EGN
		●	●				●	X-GN

Wood track



	DX	Base material						Fastener
		Green / fresh concrete	Concrete	Old / high strength concrete	Steel \geq 3 mm, bar joist	Steel \geq 6 mm, beams	Sand-lime stone, masonry	
			●	●	●	●		X-U
	●	●	●					X-C
	GX		●				●	X-GN

Fastener	Description	Approvals	Page
----------	-------------	-----------	------

	Pin length 22–72 mm, 4 mm shank diameter	●	119
	Pin length 22–72 mm, 3.5 mm shank diameter	●	129
	Pin length 18–24 mm	●	139
	Pin length 14 mm	●	139
	Pin length 20–39 mm	●	139
	Pin length 22–72 mm, 4 mm shank diameter	●	119
	Pin length 22–72 mm, 3.5 mm shank diameter	●	129
	Pin length 20–39 mm	●	139

Interior finishing

Technology	Base material						Fastener
	Green / fresh concrete	Concrete	Old / high strength concrete	Steel \geq 3 mm, bar joist	Steel \geq 6 mm, beams	Sand-lime stone, masonry	

Suspended ceilings and ceiling grid



DX		●	●	●	●			
		●	●	●				X-U
			●	●				X-C
			●	●		●		X-CC
			●	●		●		X-HS
			●	●				DNH DKH

Perimeter wall / exterior wall



DX		●	●	●	●			
					●	●		X-U
					●	●		EDS
				●	●		X-ENP	

Fastener	Description	Approvals	Page
----------	-------------	-----------	------

	Pin length 22–72 mm, 4 mm shank diameter	●	119
	Pin length 22–72 mm, 3.5 mm shank diameter	●	129
	Ceiling clip for suspension with wire	●	237
	Ceiling hanger with suspension for threaded rods	●	237
	DX Kwik, single fastening with pre-drilling	●	171
	Pin length 22–72 mm, 4 mm shank diameter	●	119
	Pin length 19–27 mm, 4.5 mm shank diameter	●	151
	Pin diameter 4.5 mm	●	87

Wood Framing

Technology	Base material						Fastener
	Wall framing	Sheeting	Roof framing	Roof paneling	Cavity battens	Trim, cladding, fencing, decking	

Dry indoor service

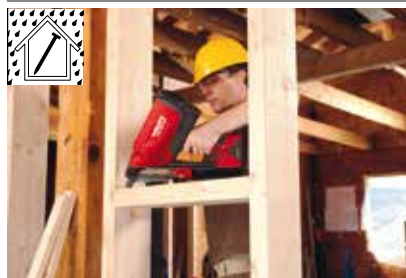

GX-WF	Wall framing	Sheeting	Roof framing	Roof paneling	Cavity battens	Trim, cladding, fencing, decking	Fastener
	●		●				
●		●					GX-WF profiled bright

Mostly dry indoor service



GX-WF	Wall framing	Sheeting	Roof framing	Roof paneling	Cavity battens	Trim, cladding, fencing, decking	Fastener
		●		●	●		
	●		●	●			GX-WF profiled galvanized

Fastener	Description	Approvals	Page
----------	-------------	-----------	------

	D-head style No coating (bright nail) Smooth shank	●	269
	No coating (bright nail) Profiled shank for increased pull-out resistance	●	269

	D-head style Zinc galvanized nail (12 µm) Smooth shank	●	269
	D-head style Zinc galvanized nail (12 µm) Profiled shank for increased pull-out resistance	●	269

Wood Framing







Technology	Base material						Fastener
	Wall framing	Sheeting	Roof framing	Roof paneling	Cavity battens	Trim, cladding, fencing, decking	

Outdoor service



Technology	Base material						Fastener
	Wall framing	Sheeting	Roof framing	Roof paneling	Cavity battens	Trim, cladding, fencing, decking	
GX-WF						●	GX-WF smooth HDG
						●	GX-WF profiled HDG
						●	GX-WF stainless clipped head A2
						●	GX-WF stainless full round head A2
						●	GX-WF stainless clipped head A4
						●	GX-WF stainless full round head A4

Fastener	Description	Approvals	Page
----------	-------------	-----------	------

	D-head style Hot dip galvanized nail (55 µm) Smooth shank	●	269
	D-head style Hot dip galvanized nail (55 µm) Profiled shank for increased pull-out resistance	●	269
	D-head style A2 Stainless steel nail Profiled shank for increased pull-out resistance	●	269
	Full round head style A2 Stainless steel nail Profiled shank for increased pull-out resistance	●	269
	D-head style A4 Stainless steel nail Profiled shank for increased pull-out resistance	●	269
	Full round head style A4 Stainless steel nail Profiled shank for increased pull-out resistance	●	269

Part 3:**DX & GX tools and equipment**

B

DX 460 General Purpose Tool

DX 460-MX



Fastener:

X-U __ MX
 X-C __ MX
 X-CT __ MX
 X-ET_MX
 X-ECT_MX
 X-EKS_MX,
 X-FB_MX
 X-HS_MX
 X-CC_MX
 X-HS-W_MX
 X-EKB_MX

Piston:

X-460-P8
 X-460-P8W
 for fastening wood

Cartridges:

6.8/11M -
 black, red, yellow, green

DX 460-F8



Fastener:

X-U __ P8 / P8 TH
 DNH 37 P8S15
 X-DKH 48 P8S15
 X-C __ P8
 X-CR __ P8/ P8S12
 X-CR M8
 X-CT __ DP8
 X-FS, X-SW
 X-FB
 X-EM6H/EW6H- __- __ FP8
 X-EF7H/- __- __ FP8
 X-M6/W6- __- __ FP8
 F7- __- __ FP8
 X-EM8H- __- __ P8
 X-M8- __- __ P8
 X-HS, X-CC
 X-HS-W_P8

Piston:

X-460-P8
 X-460-P8W
 for fastening wood

Cartridges:

6.8/11M -
 black, red, yellow, green

DX-Kwik method:

pre-drilling into concrete

Fastener:

X-M6H-__-37 FP8

X-M8H-__37 P8

X-CRM8-__42 FP8

Piston:

X-460-P Kwik

Fastener guide:

X-460-F8N15

Narrow access fastener
guide

(∅ 15.2 mm x 53.2 mm)

**Fastener:**

X-U __ P8

X-C

X-CR __ P8

X-CRM __ P8

Piston:

X-460-P8

Fastener guide:

X-460-F8N10

Narrow access fastener
guide

(bxdxL 10.4x25.9x50 mm)

**Fastener:**

X-U __ P8

X-C

X-CR __ P8

X-CRM __ P8

Piston:

X-460-P8

Fastener guide:

X-460-F8GR

Grating fastener guide

**Fastener:**

X-GR

X-PGR-RU

X-CR M8

X-EM 8H

Piston:

X-460-PGR

Fastener guide:

X-460-F8S12

S12 fastener guide

**Fastener:**

X-U __ S12

Piston:

X-460-P8

Fastener guide:

X-460-F8SS

8 mm stop spall fastener
guide



Fastener:

X-M6-__-__FP8

X-W6-__-__FP8

X-F7-__-__FP8

X-M8-__-__P8

Piston:

X-460-P8

Fastener guide:

X-460-F10



Fastener:

M10 (possible)

Piston:

X-460-P10

Fastener guide:

X-460-F10SS

10 mm stop spall fastener
guide



Fastener:

M10 (possible)

Piston:

X-460-P10

Fastener guide:

X-460-FIE-L



Fastener:

X-IE

Insulation fastener

Piston:

X-460-PIE-L

DX 460-SM**Fastener:**

X-EDNK22-THQ12M

X-EDN19-THQ12M

X-HSN 24**Piston:**

X-460-PSM**Cartridges:**

6.8/11M -

black, red, yellow

DX 351

DX 351 with X-MX27 Interior Finishing Tool



Fastener:

Piston:

X-P 8S-351

Cartridges:

6.8/11M -
red, yellow, green, white

B

DX 351-F8

Fastener:

X-C_P8/TH/THP

X-U15 P8TH

X-CC-U_-P8

X-HS __-U_P8S15

Piston:

X-P 8S-351

Cartridges:

6.8/11M -
red, yellow, green, white

Fastener guide:

X-FG 8L-351

narrow access fastener
guide

Piston:

X-P 8L-351



X-FG 8ME-351

standard fastener guide



DX 351-BT

**Fastener:**

X-BT M10-24-6 SN12-R

X-BT M10-24-6-R

X-BT W10-24-6 SN12-R

X-BT W10-24-6-R

X-BT M6-24-6 SN12-R

X-BT W6-26-6 SN12-R

X-BT-ER M10/3 SN4

X-BT-ER W10/3 SN4

X-BT-ER M8/7 SN4

X-BT-ER M6/7 SN4

X-BT-ER W6/7 SN4

Piston:

X-351 BT P 1024

Fastener guide:

BT FG M1024 (M10)

BT FG W1024 (W10)

Fastener Guide dimensions
bxdxL = 17.5x22x29.5 mm**Cartridges:**

6.8/11M -

high precision - brown

DX 351-BTG Grating

**Fastener:**

X-BT M8-15-6 SN12-R

X-BT M8-15-6-R

Piston:

X-351 BT P G

Fastener guide:

X-352 BT FG G (M8)

Fastener Guide dimensions
bxdxL = 17.5x22x56 mm**Cartridges:**

6.8/11M -

high precision - brown

DXE72

DXE72



Fastener:

X-U

X-C

X-CT

Drywall fasteners

X-SW

X-FS

X-M6/W6/F7

X-FB, X-DFB

X-CR

Cartridges:

5.6/16ND (cal .22NC) –
red, yellow, green, white
(brown), grey

B

DX 36**DX 36****Fastener:**

X-U
 X-C
 X-CR
 X-CT
 X-M6/W6/F7/M8
 X-FS
 X-SW
 X-FB
 X-DKH
 DNH
 X-M6H, X-M8H
 X-HS
 X-CC
 X-CRM

Cartridges:

6.8/11M –
 red, yellow, green

DX 2**DX 2****Fastener:**

X-U
 X-C
 X-CR
 X-CT
 X-M6/W6/F7/M8
 X-FS
 X-SW
 X-FB
 X-DKH
 DNH
 X-M6H, X-M8H
 X-HS
 X-CC
 X-CRM

Cartridges:

6.8/11M –
 red, yellow, green

DX76PTR

DX76PTR MX 76-PTR



Fastener:
X-ENP-19 L15 MX

Piston:
X-76-P-ENP-PTR

Piston brake:
X-76-PB-PTR

Cartridges:
6.8/18M - black, red, blue

Fastener:
X-ENP2K-20 L15 MX

Piston:
X-76-P-ENP2K-PTR

Piston brake:
X-76-PB-PTR

Cartridges:
6.8/18M - red, blue, green

DX76PTR (Siding and decking)



Fastener:
X-ENP-19 L15

Piston:
X-76-P-ENP-PTR

Fastener guide:
X-76-F-15-PTR

Piston brake:
X-76-PB-PTR



Cartridges:
6.8/18M - black, red, blue

Fastener:
X-ENP2K-20 L15

Piston:
X-76-P-ENP2K-PTR

Fastener guide:
X-76-F-15-PTR

Piston brake:
X-76-PB-PTR



Cartridges:
6.8/18M - red, blue, green

DX 76 PTR (Siding and decking on concrete – DX-Kwik)**Fastener:**

NPH2-42 L15

Piston:

X-76-P-Kwik-PTR

Fastener guide:

X-76-F-Kwik-PTR

Piston brake:

X-76-PB-PTR

**Cartridges:**

6.8/18M – blue, yellow

DX 76 PTR (X-HVB shear connectors)**Fastener:**

X-ENP-21 HVB

Piston:

X-76-P-HVB-PTR

Connector:

X-HVB shear connectors

Piston stop:

X-76-PB-PS

Fastener guide:

X-76-F-HVB-PTR

Cartridges:

6.8/18M – black, red



DX 76 PTR (Grating and chequer plate)



Grating fastener:

X-CRM8-15-12 P8

X-EM8H_P8

Chequer plate fastener

X-CRM8-15-12 P8

X-CRM8-9-12 P8

Fastener guide:

X-76-F-8-GR-PTR

(Δ 19 mm ∞ 58 mm)

Piston:

X-76-P-8-GR-PTR

Piston brake:

X-76-PB-PTR

Cartridges:

6.8/18M -

blue, yellow

For X-GR and X-GRRU:

red, blue, yellow



DX 76 PTR (Heavy duty)



Fastener:

EDS19 - 22 P10

X-EM10H-24-12 P10

X-EM8H-15-12 FP10

X-CR M8-15-12 FP10

X-CR M8-9-12 FP10

DS27 - 37 P10

Fastener guide:

X-76-F-10-PTR

(Δ 19 mm ∞ 58 mm)

Piston:

X-76-P-10-PTR

Piston brake:

X-76-PB-PTR

Cartridges:

6.8/18M -

black, red, blue



DX 76**DX 76 MX** (Siding and decking) with magazine**Fastener:**

X-ENP-19 L15 MX

Piston:

X-76-P-ENP

Cartridges:

6.8/18M – black, red, blue

Fastener:

X-ENP2K-20 L15 MX

Piston:

X-76-P-ENP2K

Cartridges:6.8/18M –
red, blue, yellow, green**DX 76 F15** (Siding and decking)**Fastener:**

X-ENP-19 L15

Piston:

X-76-P-ENP

Cartridges:

6.8/18M – black, red, blue

Fastener:

X-ENP2K-20 L15

Piston:

X-76-P-ENP2K

Cartridges:6.8/18M –
red, blue, yellow, green

DX 76 F15 (Siding and decking on concrete – DX-Kwik)



Fastener:

NPH2-42 L15

Piston:

X-76-P-Kwik

Fastener guide:

X-76-F-Kwik

Cartridges:

6.8/18M – blue, yellow



DX 76 F15 (X-HVB shear connectors)



Fastener:

X-ENP-21 HVB

Piston:

X-76-P-HVB

Connector:

X-HVB shear connectors

Cartridges:

6.8/18M – black, red

Fastener guide:

X-76-F-HVB



DX 76 F15 (Grating and checker plate)**Grating fastener:**

X-CRM8-15-12 FP10

EM8-15-14-10 FP10

Checker plate fastener

X-CRM8-15-12 FP10

X-CRM8-9-12 FP10

Fastener guide:

X-76-F-10

**Piston:**

X-76-P-GR

Cartridges:6.8/18M –
black, red, blue, yellow,
green**DX 76 F15** (Heavy duty)**Fastener: (for nail)**

EDS 19 – 27 P10

Fastener: (for stud)

X-EM10-24-14 P10

Fastener guide:

X-76-F-10

for nails and studs

**Piston: (for nail)**

X-76-P-10

Piston: (for stud)

X-76-P-GR

Cartridges:6.8/18M –
black, red, blue, yellow,
green

DX-860 Tool for Decking

DX 860-ENP



Fastener:

X-ENP-19 L15 MXR

Piston:

X-76-P-ENP

Cartridges:

6.8/18M40 –
black, red, blue

DX 860-HSN



Fastener:

X-EDNK22-THQ12M

X-EDN19-THQ12M

X-HSN 24

Piston:

X-860-P10

**Piston and piston brake
spare part:**

DX 860-HSN spare part
pack

Cartridges:

6.8/11M40 –
black, red, yellow

Cartridges

Cartridge 6.8/11M10 and 6.8/11M40¹ (.27 caliber short)



Color code*	Power level**	Fastening tools:			
		DX 36, DX 2	DX 460	DX 351	DX 860-HSN ¹
High precision brown	2 [2]	no	no	✓	no
white [brown]	2 [2]	no	no	✓	no
green	3 [3]	✓	✓	✓	no
yellow	4 [4]	✓	✓	✓	no
red	6 [5]	✓	✓	✓	✓
black [purple]	7 [6]	no	✓	no	no

Cartridge 6.8/18M10 (.27 caliber long)



Color code*	Power level**	Fastening tools:	
		DX 76 / DX 76 PTR	
green	3	✓	
yellow	4	✓	
blue	5 [4.5]	✓	
red	6 [5]	✓	
black [purple]	7 [6]	✓	

Cartridge 6.8/18M40 (.27 caliber long)



Color code*	Power level**	Fastening tools:	
		DX 860-ENP	
blue	5 [4.5]	✓	
red	6 [5]	✓	
black [purple]	7 [6]	✓	

Cartridge 5.6/16ND (caliber .22NC)

Color code*	Power level**	Fastening tools:	
		DX-E 72	
[grey]	[1]	✓	
white [brown]	2	✓	
green	3	✓	
yellow	4	✓	
red	6	✓	

6.8/18 (.27 caliber long)¹

Color code*	Power level**	Fastening tools:	
		DX 600N ¹	
green	3	✓	
yellow	4	✓	
red	5	✓	
black [purple]	7 [6]	✓	

* Color code according to DIN 7260, in brackets e.g. [purple] according to PATMI (USA and Canada)

** Power level as used on Hilti packaging. Without brackets refers to level used in Europe, in brackets e.g. [6] refers to number according to PATMI and as used in USA and Canada.

GX 90 WF (Wood framing)

GX 90 WF (Wood framing)



Fastener:

- GX-WF ___
smooth bright MX 34
- GX-WF ___
profiled bright MX 34
- GX-WF ___
smooth galvanized MX 34
- GX-WF ___
profiled galvanized MX 34
- GX-WF ___
smooth HDG MX 34
- GX-WF ___
profiled HDG MX 34
- GX-WF ___
profiled A2 stainless D-head

- GX-WF ___
profiled A2 stainless full
round head
- GX-WF ___
profiled A4 stainless D-head
- GX-WF ___
profiled A4 stainless full
round head

Energy:

GC 32

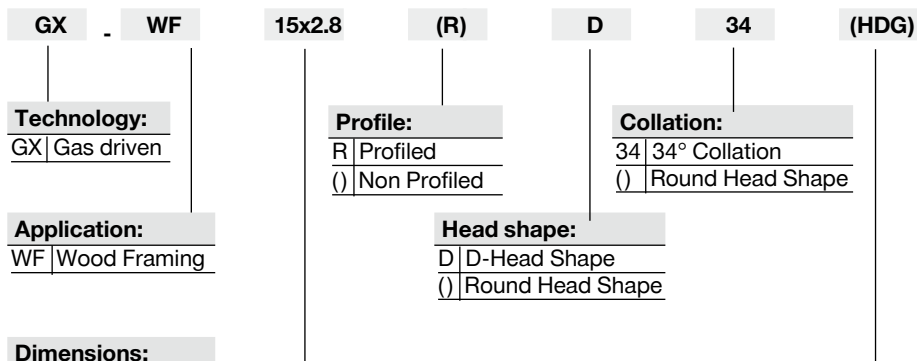

Technology:

GX | Gas driven

Application:

WF | Wood Framing

Dimensions:

Length and Nails
Diameter in mm

Profile:

- R | Profiled
- () | Non Profiled

Head shape:

- D | D-Head Shape
- () | Round Head Shape

Collation:

- 34 | 34° Collation
- () | Round Head Shape

Corrosion protection:

Suffix	Type of protection	Service Class (EN 1995-1-1)
"Bright"	no coating	1
"Galv"	12 µm cinc	1, 2
"HDG"	55 µm hot dip galvanized	1, 2, 3
"Stainless"	A2 or A4	1, 2, 3

GX 100 Gas Tool for Interior Finishing and GX 100-E for Electrical Applications

GX 100



Fastener:

X-EGN 14 MX
 X-GHP 16 MX
 X-GHP 18 MX
 X-GHP 20 MX
 X-GHP 24 MX
 X-GN 20 MX
 X-GN 27 MX
 X-GN 32 MX
 X-GN 39 MX

Energy:

GC 11 used international



GC 12 used only in USA

GX 100-E



Fastener:

X-EGN 14 MX
 X-GHP 16 MX
 X-GHP 18 MX
 X-GHP 20 MX
 X-GHP 24 MX
 X-GN 20 MX
 X-GN 27 MX
 X-GN 32 MX
 X-GN 39 MX
 X-EHS MX
 X-ECC MX
 X-HS-W MX
 X-EKB MX
 X-FB MX
 X-DFB MX
 X-ECT MX
 X-ET MX
 X-EKS MX
 X-EMTSC

Energy:

GC 11 used international



GC 12 used only in USA

GX 120 Gas Tool for Interior Finishing and GX 120-ME for Electrical Applications

GX 120



Fastener:

- X-EGN 14 MX
- X-GHP 16 MX
- X-GHP 18 MX
- X-GHP 20 MX
- X-GHP 24 MX
- X-GN 20 MX
- X-GN 27 MX
- X-GN 32 MX
- X-GN 39 MX

Energy:

- GC20. GC 21 and GC 22



GX 120-ME



Fastener:

- X-EGN 14 MX
- X-GHP 16 MX
- X-GHP 18 MX
- X-GHP 20 MX
- X-GHP 24 MX
- X-GN 20 MX
- X-GN 27 MX
- X-GN 32 MX
- X-GN 39 MX
- X-EHS MX
- X-ECC MX
- X-HS-W MX
- X-EKB MX
- X-FB MX
- X-DFB MX
- X-ECT MX
- X-ET MX
- X-EKS MX
- X-EMTSC
- X-G M6/W6
- X-UCT MX
- X-SW 30, X-SW 60



Energy:

- GC20. GC 21 and GC 22

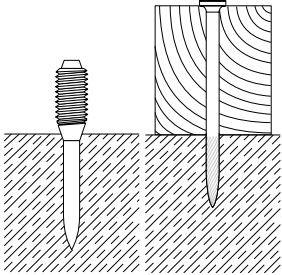

Tips for users (“Trouble Shooting”)

DX fastenings on concrete

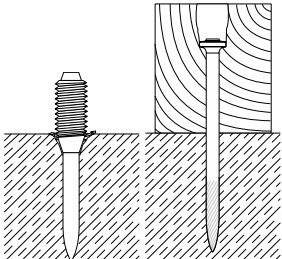
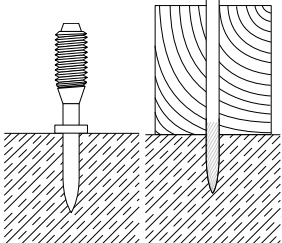
Fault	Cause	Possible remedial measures
<p>Fastener properly fixed</p> 	<ul style="list-style-type: none"> ■ Proper*) length of fastener ■ Proper cartridge ■ Proper power setting 	
<p>Fastener penetrates too deep</p> 	<ul style="list-style-type: none"> ■ Fastener too short*) ■ Too much driving power 	<ul style="list-style-type: none"> ■ Use longer fastener ■ Reduce power setting ■ Use lighter cartridge
<p>Fastener does not penetrate deep enough</p> 	<ul style="list-style-type: none"> ■ Fastener too long*) ■ Too little driving power 	<ul style="list-style-type: none"> ■ Use shorter fastener ■ Increase power setting ■ Use heavier cartridge

*) **Rule of thumb:** The higher the compressive strength of concrete, the shorter the fastener
Proper length (mm): $L_s = 22 + t_1$ (compare, “Fastening Technology Manual” Part Product section)

DX fastenings on concrete

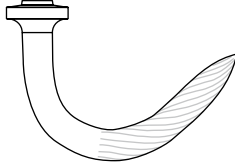
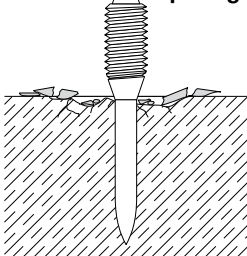
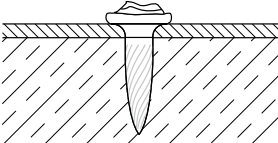
Fault	Cause	Possible remedial measures
<p>Nail is bending</p> 	<ul style="list-style-type: none"> ■ Hard and/or large aggregate in concrete ■ Rebar close to surface of concrete ■ Hard surface (steel) 	<ul style="list-style-type: none"> ■ Use shorter nail ■ Use DX-Kwik (predrill) ■ Use co-acting principle/ fastener guide ■ Use stepped shank nail X-U 15 ■ Change cartridge
<p>Base material is spalling</p> 	<ul style="list-style-type: none"> ■ High strength concrete ■ Hard and/or large aggregate in concrete ■ Old concrete 	<ul style="list-style-type: none"> ■ Stud application: Use spall stop X-460-F8SS / - F10SS ■ Nail application: Use shorter nail Use DX-Kwik (predrill) Use X-U 15 (for high-strength precast concrete)
<p>Damaged nail head</p> 	<ul style="list-style-type: none"> ■ Too much driving power ■ Wrong piston used ■ Damaged piston) 	<ul style="list-style-type: none"> ■ Reduce power setting ■ Use lighter cartridge ■ Check nail-piston-combination ■ Change piston

Wrong pistons can cause all the above faults: match pistons to nails!

Fastener	Piston	Piston head
X-U, X-C	Use piston X-460-P8	

DX fastenings on steel

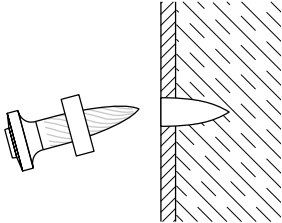
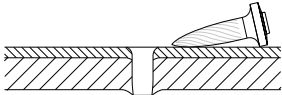
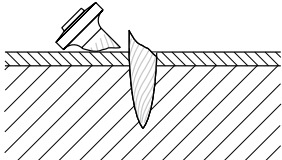
Fault	Cause	Possible remedial measures
<p>Nail does not penetrate surface</p> 	<ul style="list-style-type: none"> ■ Too little driving power ■ Application limit exceeded (very hard surface) ■ Unsuitable system 	<ul style="list-style-type: none"> ■ Try higher power setting or heavier cartridge ■ Short nail application: Try X-U 15 ■ Long nail application: Try X-U ■ Use co-acting principle/ fastener guide ■ Switch to heavy system like DX 76 PTR
<p>Nail does not hold in base material</p> 	<ul style="list-style-type: none"> ■ Excess driving energy in thin steel base material (3 to mm steel) 	<ul style="list-style-type: none"> ■ Try different power setting or different cartridge ■ Try X-ENP2K or X-EDNK22 THQ 12 for fastening sheet metal
<p>Nail is breaking</p> 	<ul style="list-style-type: none"> ■ Too little driving power ■ Application limit exceeded (very hard surface) 	<ul style="list-style-type: none"> ■ Try higher power setting or heavier cartridge ■ Use shorter nail ■ Use X-ENP19 ■ Use stronger nail (X-...-H) ■ Use stepped shank nail: X-U 15

DX fastenings on steel

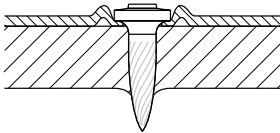
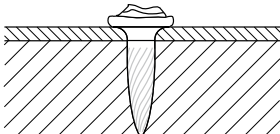
Fault	Cause	Possible remedial measures
<p>Nail head penetrates through material fastened (metal sheet)</p> 	<ul style="list-style-type: none"> ■ Too much driving power 	<ul style="list-style-type: none"> ■ Reduce power setting ■ Use lighter cartridge ■ Use nail with Top Hat ■ Use nail with washer e.g. X-U ...S12
<p>Damaged nail head</p> 	<ul style="list-style-type: none"> ■ Too much driving power ■ Wrong piston used ■ Worn-out piston 	<ul style="list-style-type: none"> ■ Reduce power setting ■ Use lighter cartridge ■ Check nail-piston-combination ■ Change piston

B

Wrong pistons can cause all the above faults: match pistons to nails!

Fastener	Piston	Piston head
X-U	Use piston X-460-P8	

Part 4:

DX and GX fasteners

X-ENP Siding and Decking Nail

Product data

Dimensions

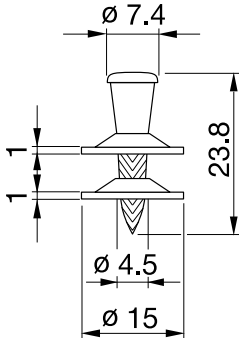

General information

Material specifications

Carbon steel shank:	HRC 58
Zinc coating:	8–16 µm

Recommended fastening tools

	Single nail: X-ENP-19 L15
DX 76 F15, DX 76 PTR with X-76-F15-PTR fastener guide	
DX 76 MX, DX 76 PTR	Collated nails: X-ENP-19 L15 MX, white magazine strip X-ENP-19 L15 MXR, grey magazine strip
DX 860-ENP	

See **Tools and equipment** for more details.

Approvals

ETA-04/0101 (Hilti-DX-DoP001), UL R13203, FM 3021719, ICC ESR-2197, ESR-2776 (USA), MLIT (Japan), ABS, LR 97/00077

Applications

Examples

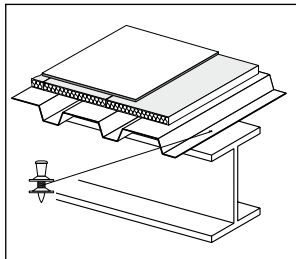

Roof decking

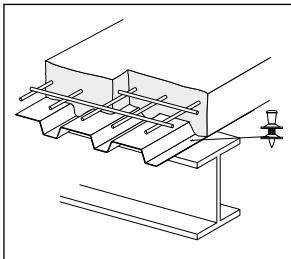

Floor decking

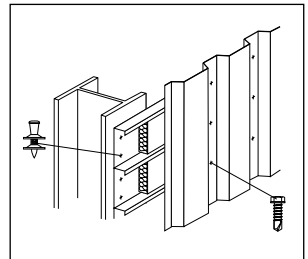

Wall liners

The intended use only comprises fastenings which are not directly exposed to external weather conditions or moist atmospheres. For out-door applications, that can be ensured by using SDK2 sealing caps. During construction exposure to external atmosphere must not exceed 6 months. Fastening of aluminum sheeting is generally recommended only for indoor conditions.

Load data

Characteristic loads – steel sheeting

Sheeting thickness t_t [mm]	Trapezoidal profile (symmetric loading)		Liner trays ¹⁾ (asymmetric loading)	
	Char. resistance according to ETA-04/0101		Char. resistance keeping to ETA-04/0101	
nominal	Shear V_{Rk} [kN]	Tension N_{Rk} [kN]	Shear V_{Rk} [kN]	Tension N_{Rk} [kN]
0.75	4.70	6.30	3.30	4.40
0.88	5.40	7.20	3.80	5.00
1.00	6.00	8.00	4.20	5.60
1.13	7.00	8.40	4.90	5.90
1.25	8.00	8.80	5.60	6.20
1.50	8.60	8.80	6.00	6.20
1.75	8.60	8.80	6.00	6.20
2.00	8.60	8.80	6.00	6.20
2.50	8.60	8.80	6.00	6.20

• N_{Rk} and V_{Rk} are valid for steel sheet with minimum tensile strength ≥ 360 N/mm² (\geq S280 EN 10346).

• For intermediate sheet thicknesses, use recommended load for next smaller thickness or linear interpolation.

1) Required load reduction is taken into account in accordance with EN 1993-1-3: 2006, section 8.3 (7) and fig. 8.2. See also construction rules under spacings and edge distances.

Recommended loads – steel sheeting

Sheeting thickness t_t [mm]	Trapezoidal profile (symmetric loading)		Liner trays ¹⁾ (asymmetric loading)	
	Recommended loads		Recommended loads	
nominal	Shear V_{rec} [kN]	Tension N_{rec} [kN]	Shear V_{rec} [kN]	Tension N_{rec} [kN]
0.75	2.50	3.35	1.75	2.35
0.88	2.90	3.85	2.00	2,70
1.00	3.20	4.25	2.25	3.00
1.13	3.75	4.50	2.65	3.15
1.25	4.25	4.70	3.00	3.30
1.50	4.60	4.70	3.20	3.30
1.75	4.60	4.70	3.20	3.30
2.00	4.60	4.70	3.20	3.30
2.50	4.60	4.70	3.20	3.30

• N_{rec} and V_{rec} are valid for steel sheet with minimum tensile strength ≥ 360 N/mm² (\geq S280 EN 10346).

• For intermediate sheet thicknesses, use recommended load for next smaller thickness or linear interpolation.

• Recommended loads N_{rec} and V_{rec} are appropriate for Eurocode 1 wind loading design with a partial safety factor $\gamma_F = 1.5$ for wind load and a partial resistance factor $\gamma_M = 1.25$ for the fastening.

1) Required load reduction is taken into account in accordance with EN 1993-1-3: 2006, section 8.3 (7) and fig. 8.2. See also construction rules under spacings and edge distances.

Recommended loads – aluminum sheeting¹⁾ with $f_u \geq 210 \text{ N/mm}^2$

Trapezoidal profile (symmetric loading)

Thickness t_f [mm]	Shear V_{rec} [kN]	Tension N_{rec} [kN]
0.60	0.75	0.35
0.70	0.90	0.50
0.80	1.00	0.65
0.90	1.20	0.80
1.00	1.30	0.95
1.20	1.55	1.30
1.50	1.85	1.45
2.00	2.55	1.90

- 1) Only recommended for indoor applications. Constraint forces and corrosion aspects have to be considered.
- For intermediate sheet thicknesses, use recommended load for next smaller thickness.
- Recommended loads N_{rec} and V_{rec} are appropriate for Eurocode 1 wind loading design with a partial safety factor of $\gamma_F = 1.5$ for wind load and a partial resistance factor $\gamma_M = 1.25$ for the fastening.

Recommended loads – other applications

	V_{rec} [kN]	N_{rec} [kN]
	4.6	2.4

- **Fastened parts:** clips, brackets, etc.; thick steel parts ($t_{l,max} = 2.5 \text{ mm}$).
- Redundancy (multiple fastening) must be provided.
- The possibility of prying effects has to be considered
- Failure of the fastened part is not considered in these values of N_{rec} , V_{rec} .
- Valid for predominantly static loading
- Global factor of safety is ≥ 2 based on 5% fracture value

Design

Depending on the verification concept, the corresponding design criteria are given as following.

Working load concept	Partial safety concept
Tensile loads $N_{Sk} \leq N_{rec}$	$N_{Sd} \leq N_{Rd}$
Shear loads $V_{Sk} \leq V_{rec}$	$V_{Sd} \leq V_{Rd}$

N-V Interaction

For combined tensile and shear forces on the fastener, a linear function has to be used.

$$\left(\frac{V_{Sk}}{V_{rec}}\right) + \left(\frac{N_{Sk}}{N_{rec}}\right) \leq 1$$

with:

V_{Sk} , N_{Sk} unfactored characteristic load acting on the fastening (= working load)

V_{rec} , N_{rec} recommended (allowable) load with $\gamma_{GLOBAL} = 1.875$

$$\left(\frac{V_{Sd}}{V_{Rd}}\right) + \left(\frac{N_{Sd}}{N_{Rd}}\right) \leq 1$$

with:

V_{Sd} , N_{Sd} Design load with $\gamma_F = 1.5$

V_{Rd} , N_{Rd} Design resistance of the fastening with $\gamma_M = 1.25$

$V_{Rd} = V_{Rk} / 1.25$

$N_{Rd} = \alpha_{cycl} N_{Rk} / 1.25$

$\alpha_{cycl} = 1.0$ according to ETA-04/0101

Application requirements

Thickness of base material

Steel thickness t_{II}

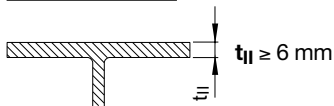

Thickness of fastened material

$\Sigma t_{i, \text{tot}} \leq 4.0 \text{ mm}$

Sheet thicknesses and overlap types

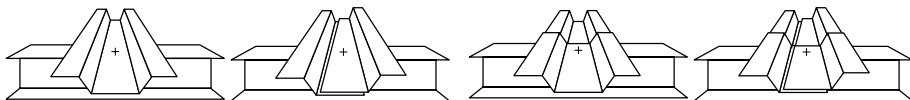

(a)
single

(b)
side lap

(c)
end overlap

(d)
side lap and end overlap

Nominal sheeting thickness t_i [mm]

Allowable overlap types

0.63–1.00

a, b, c, d

> 1.00–1.25

a, c

> 1.25–2.50

a

With the above recommended sheet thickness and overlap types, it is not necessary to take into account the effect of constraints due to temperature for steel grades up to S320 (EN 10346). For steel grade S350 (EN 10346) it shall be considered for design. Sheets of grade S350 on base material $t_{II} \geq 8 \text{ mm}$ have been verified by Hilti, forces of constraint can be neglected.

Spacing and edge distances (mm)

Steel base material

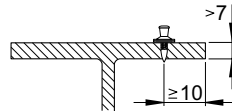
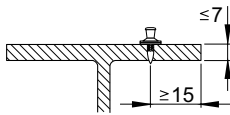

Trapezoidal profiles

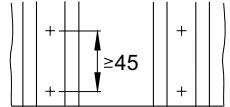
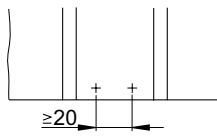
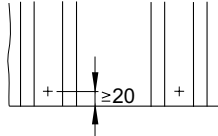
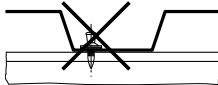
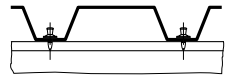
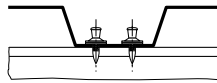
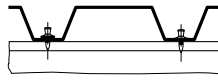
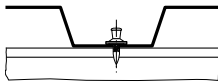

Centre fastenings in ribs

Clearance to end of sheet

Double fastenings (asymmetric)

Note:
Reduce tensile resistance per fastener to $0.7 N_{Rk}$ or $0.7 N_{rec}$.

Liner trays

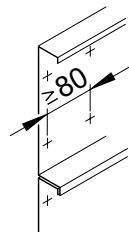
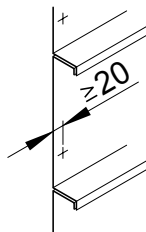
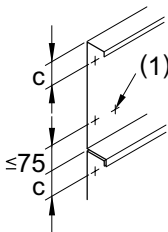
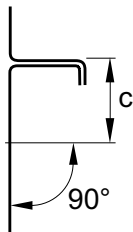

Clearance to side of sheet

Clearance to side of sheet

Clearance to end of sheet

Fastener spacing along sheet

When driving the fastener, the fastening tool needs to be positioned perpendicular to the surface.
If $c > 75$ mm, it is recommended to drive an additional fastener at the other side of the tray. This additional fastener is indicated with (1) in the graph above.

Corrosion information

The intended use only comprises fastenings which are not directly exposed to external weather conditions or moist atmospheres. For outdoor applications that can be ensured by using **SDK 2** sealing caps. During construction exposure to external atmosphere must not exceed 6 Month. Fastening of Aluminum sheeting is generally recommended only for indoor conditions.

Application limit

X-ENP-19 with DX 76, DX 76 PTR and DX 860-ENP

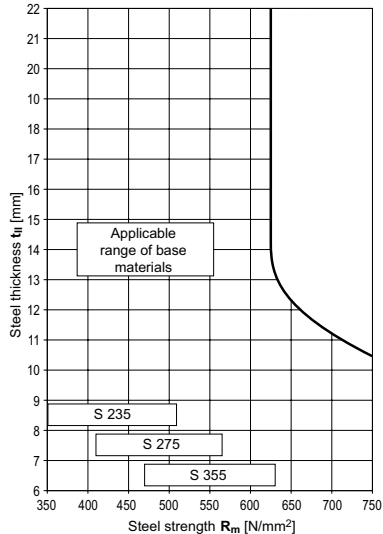

Fastener selection and system recommendation

Fasteners			Tools	Fastener guide
	Designation	Item no.	Designation	Designation
Single nail:	X-ENP-19 L15	283506	DX 76 PTR DX 76 F15	X-76-F15-PTR
Collated nails:	X-ENP-19 L15 MX, white magazine strip	283507	DX 76 PTR DX 76 MX	
	X-ENP-19 L15 MXR, grey magazine strip	283508	DX 860-ENP	
Piston:	X-76-P-ENP-PTR		DX 76 PTR	
	X-76-P-ENP		DX 76 DX 860-ENP	

Cartridge selection and tool energy setting

DX 76, DX 860-ENP

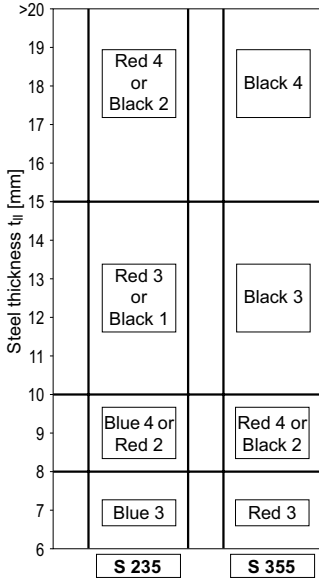

DX 76 PTR

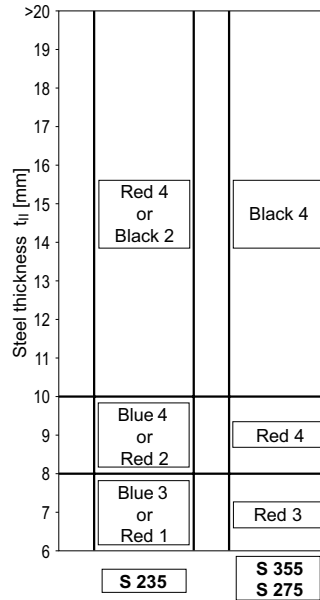

Fine adjustment by installation tests on site.

Note for S275:

Start with recommendation for S355. In case of too much energy: reduction of tool energy setting or change of cartridge colour till correct nail head stand-offs h_{NVS} are achieved.



Fastening quality assurance

Fastening inspection

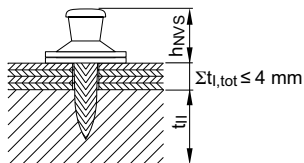

$h_{NVS} = 8.2-9.8 \text{ mm for } t_{i,tot} \leq 4 \text{ mm}$

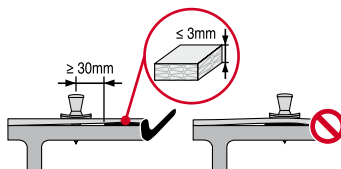

In order to allow the steel sheeting to be in direct contact with the steel supporting structure in the area of connections the X-ENP-19 fastener should be installed $\geq 30\text{mm}$ away from the edges of insulation / isolation tapes that are $\leq 3\text{mm}$ thick.

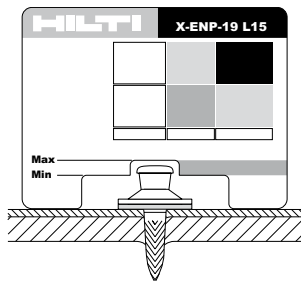

$h_{NVS} = 8.2-9.8 \text{ mm}$

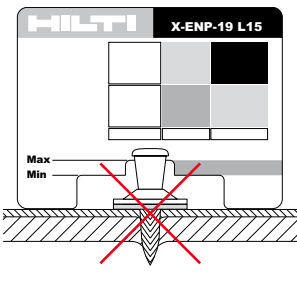

$h_{NVS} > 9.8 \text{ mm}$
(washers are not compressed)

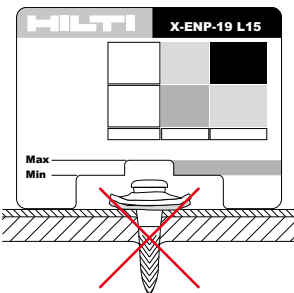

$h_{NVS} < 8.2 \text{ mm}$
(washers are strongly damaged by the tool piston)



Visible inspection:
Properly driven fastener.
Piston mark clearly visible on the washer.

SDK2, PDK2 Sealing Caps for Cladding Fastening

Product data

Dimensions

SDK2 sealing cap

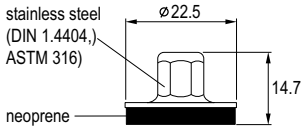

PDK2 sealing cap

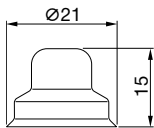

General information

Compatible DX fasteners

X-ENP-19 L15

Base material thickness $t_{II} \geq 6 \text{ mm}$

Fastening tool

SW/SDK2 setting tool **SDK2**

SW/PDK2 setting tool **PDK2**

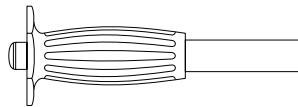

Applications

Examples

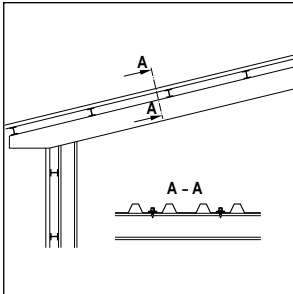

Roof and wall cladding on single skin buildings

SDK2, stainless steel sealing cap for roof and wall cladding

Stainless steel cap not affected by atmospheric corrosion

Space under the cap isolated from the atmosphere

Neoprene washer insulates against contact corrosion and seals the space under the cap-off from the atmosphere

Pressure on the washer seals the gap between the sheet and the base steel

PDK2, plastic sealing cap for wall cladding

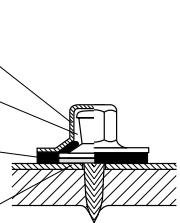

Corrosion protection

Fastening quality assurance

Fastening inspection

For detailed information on X-ENP-19 L15 please see the according product pages.

X-ENP-19 L15

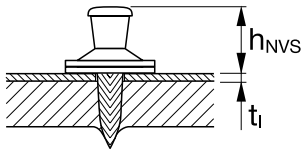

Maximum thickness of single layer (type a):
 $t_{i, \max} = 1.5 \text{ mm}$
 Total thickness of end overlap (type c):
 $\Sigma t_{i, \text{tot}} \leq 2.5 \text{ mm}$

$h_{NVS} = 8.2\text{--}9.8 \text{ mm}$

Note:

It has to be ensured, that the fastened sheet is properly compressed to the base material and no gap remains at fastening point location.

Installation

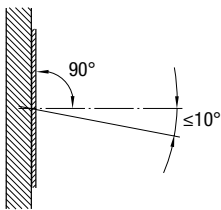

Position the DX tool so that nail inclination is limited to max. 10° from perpendicular to surface

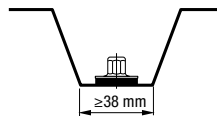
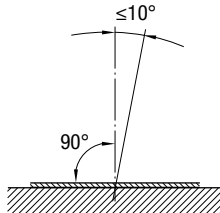

Centre fastening in valley.
 38 mm min. valley width

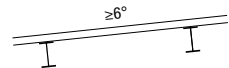

Minimum roof slope 6°

These are abbreviated instructions which may vary by application.

ALWAYS review/follow the instructions accompanying the product.

X-ENP 2K Siding and Decking Nail

Product data

Dimensions

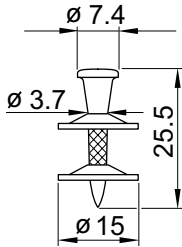

General information

Material specifications

Carbon steel shank:	HRC 55.5
Zinc coating:	8–16 μm

Recommended fastening tools

	Single nail:
DX 76 PTR with	X-ENP 2K-20 L15
X-76-F-15-PTR fastener guide	
DX 76 MX with	
X-76-FN15 fastener guide	

	Collated nails:
DX 76 PTR.	X-ENP 2K-20 L15 MX
DX 76 MX	(green magazine strip)

See **Tools and equipment** for more details.

Approvals

BUTgb (Belgium), ABS, 13/0172
(Hilti-DX-DoPo003),
LR 97/00077



Note: technical data presented in these approvals and design guidelines reflect specific local conditions and may differ from those published in this handbook.

Applications

Examples

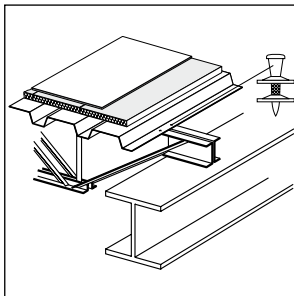

Roof and floor decking

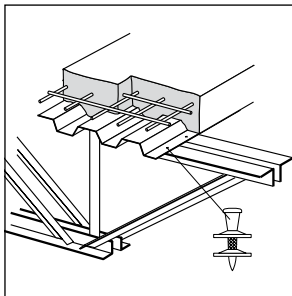

Roof and floor decking

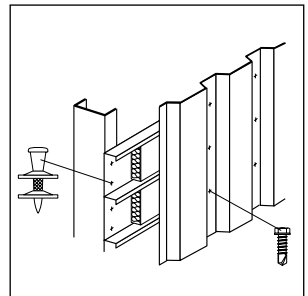

Wall liners

Load data

Characteristic loads

Overlap Sheeting thickness t_l [mm]	$3 \text{ mm} \leq t_{il} < 4 \text{ mm}$		Types of conn.	$4 \text{ mm} \leq t_{il} \leq 6 \text{ mm}$		Types of conn.
	V_{Rk} [kN]	N_{Rk} [kN]		V_{Rk} [kN]	N_{Rk} [kN]	
0.75	4.70	6.00	a, c	4.70	6.30	a, b, c, d
0.88	5.40	6.00	a, c	5.40	7.20	a, (b)*, c, d,
1.00	6.00	6.00	a, c	6.00	8.00	a, (b)*, c, d
1.13	–	–	–	7.00	8.40	a, c
1.25	–	–	–	8.00	8.80	a, c
1.50	–	–	–	8.60	8.80	a

* Fastening type (b) covered for $5 \text{ mm} \leq t_{il} < 6 \text{ mm}$, if N_{Rk} is reduced to 6.6 kN

Fastening type (b) fully covered for $t_{il} = 6 \text{ mm}$

For a, b, c, d please refer to **Application requirements, Sheet thicknesses and overlap types**

Design

Design shear and tension resistance V_{Rd} and N_{Rd}

$$V_{Rd} = V_{Rk} / \gamma_M \quad N_{Rd} = \alpha_{cycl} V_{Rk} / \gamma_M \text{ with } \alpha_{cycl} = 1.0 \text{ for all sheeting thickness } t_l$$

α_{cycl} considers the effect of repeated wind loads

$\gamma_M = 1.25$ in the absence of national regulations

Characteristic tension resistances N_{Rk} [kN/m] and shear resistances V_{Rk} [kN/m] per unit length, taking the effect of thermal constraints into account

N_{Rk} and V_{Rk} characteristic shear and tension resistance

w ... width of the panel sheet

$$n_{Rk} = 0.9 \cdot 2 \cdot N_{Rk} / W \quad v_{Rk} = 2 \cdot V_{Rk} / W$$

$$n_{Rk} = 0.9 \cdot 3 \cdot N_{Rk} / W \quad v_{Rk} = 3 \cdot V_{Rk} / W$$

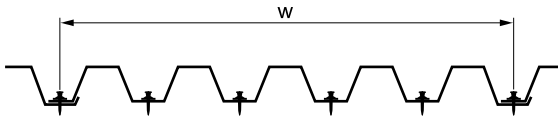

$$n_{Rk} = 0.9 \cdot 4 \cdot N_{Rk} / W \quad v_{Rk} = 4 \cdot V_{Rk} / W$$

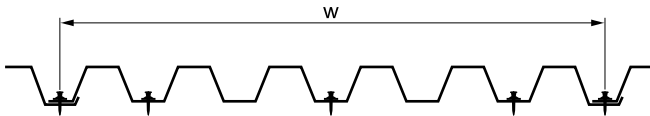

$$n_{Rk} = 0.9 \cdot 5 \cdot N_{Rk} / W \quad v_{Rk} = 5 \cdot V_{Rk} / W$$

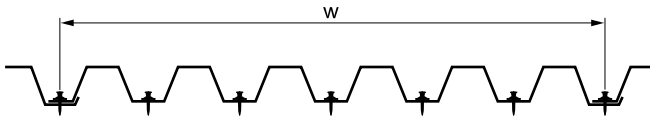

$$n_{Rk} = 3 \cdot N_{Rk} / W \quad v_{Rk} = 3 \cdot V_{Rk} / W$$

The same characteristic resistances can also be applied along supports at end-overlaps, if connection type "d" is not covered in the load table.

Application requirements

Thickness of base material

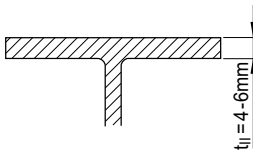

$t_{II} = 4.0 - 6.0$ mm for general shapes

Fastening to cold-formed C- and Z-sections with a thickness from 2.9 to 4.0 mm

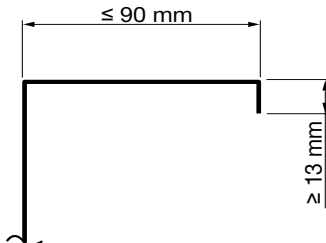

Grade: \geq S320 GD according to EN 10346

Fastening to U-shape concrete inlays with a nominal thickness t_{II} of 3 mm.

$t_{II} = 3.0 \pm 0.3$ mm

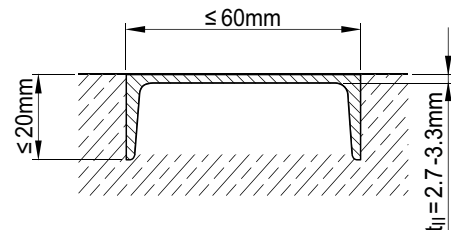

Sheet thicknesses and overlap types

Type (a)

single

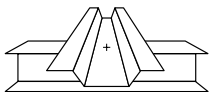

Type (b)

side lap

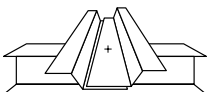

Type (c)

end overlap

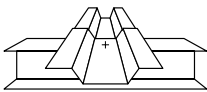

Type (d)

side lap and end overlap

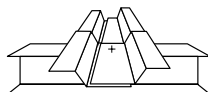

Edge distances (mm)

Rolled I or wide flange shapes

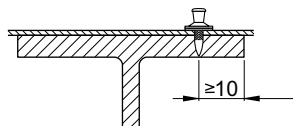

Angles

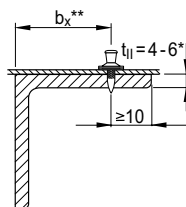

* For $t_{lf} = 3$ to 4 mm, restrictions on application. See approval or contact Hilti.

** Maximum recommended $b_x \leq 8 \times t_{lf}$ however, jobsite verification advisable.

Trapezoidal profiles

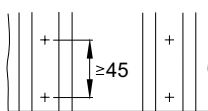
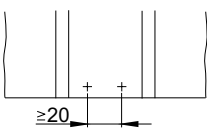
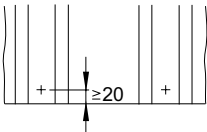
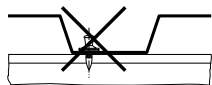
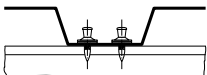
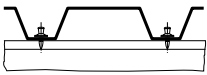
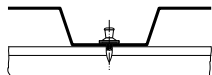

Centre fastenings in ribs

Clearance to end of sheet

Double fastenings

Note:
Reduce tensile resistance per fastener to $0.7 N_{rec}$.

Corrosion information

The intended use only comprises fastenings which are not directly exposed to external weather conditions or moist atmospheres. For further detailed information on corrosion see corresponding chapter in **Direct Fastening Principles and Technique** section.

Application limits

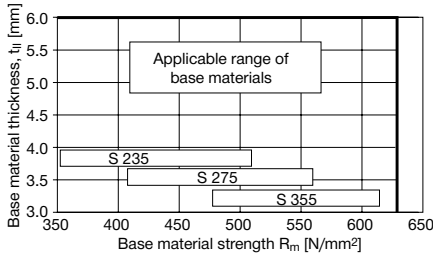

Fastener selection and system recommendation

Fasteners	Designation	Item no.	Tools	Fastener guide
			Designation	Designation
Single nail:	X-ENP 2K-20 L15	385133	DX 76 PTR	X-76-F-15-PTR
			DX 76 MX	X-76-FN15
Collated nails:	X-ENP 2K-20 L15 MX	385134	DX 76 PTR DX 76 MX	
Piston:	X-76-P-ENP2K-PTR		DX 76 PTR	
	X-76-P-ENP2K		DX 76 MX	

Cartridge selection and tool energy setting

DX 76 PTR

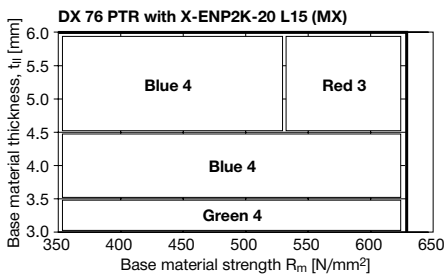

DX 76

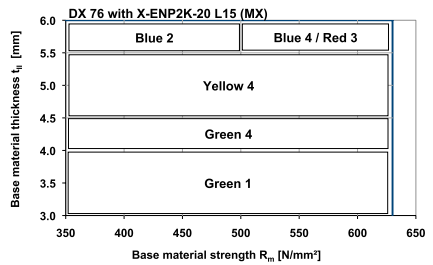

Fine adjustment by installation tests on site.

Fastening quality assurance

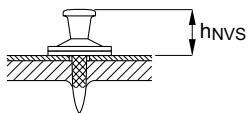

$h_{NVS} = 7-11 \text{ mm}$

C

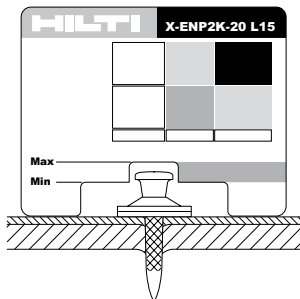

$h_{NVS} = 7-11 \text{ mm}$

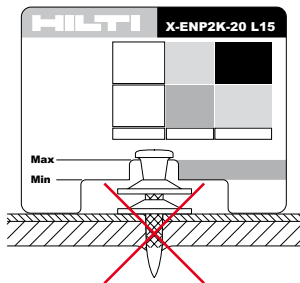

$h_{NVS} > 11 \text{ mm}$

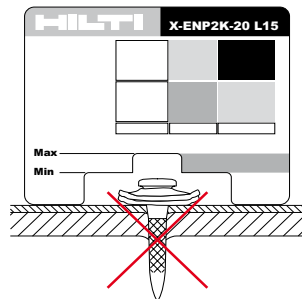

$h_{NVS} < 7 \text{ mm}$

X-HSN 24, X-EDNK22 THQ12, X-EDN19 THQ12 Diaphragm Decking Nails

Product data

Dimensions

X-HSN 24

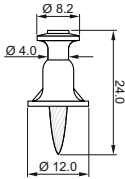

X-EDNK22 THQ12 M

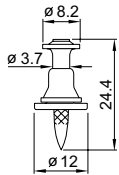

X-EDN19 THQ12 M

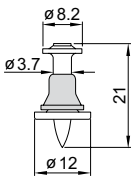

General information

Material specifications

Carbon steel shank:	HRC 55.5
Zinc coating:	5–13 µm

Recommended fastening tool

DX 860-HSN	Collated nails: X-HSN 24 red magazine strip X-EDNK22 THQ12 M, grey magazine strip X-EDN19 THQ12 M, white magazine strip
------------	---

See **Tools and equipment** for more details.

Approvals

FM, SDI	X-HSN 24
FM, UL, ICC, SDI (USA), ABS, LR	X-EDN 19, X-EDNK22

Note:

Technical data presented in these approvals and design guidelines reflect specific local conditions and may differ from those published in this hand-book.

Applications

Examples

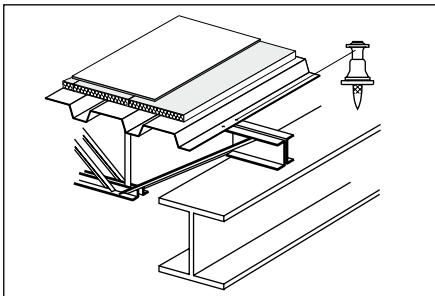

Roof decking (diaphragm design)

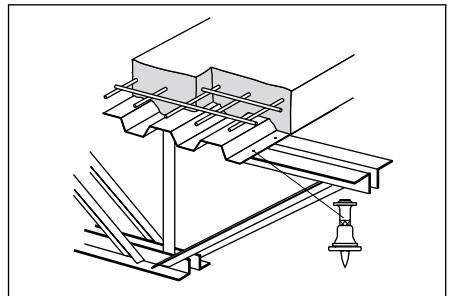

Floor decking (diaphragm design)

Load data

Design data for use in the U.S.A.

Diaphragm strength

Approvals provide load tables or calculation procedures for determination of the allowable strength (in lbs/ft or kN/m) of a steel deck diaphragm. The allowable diaphragm strength depends on the type, strength and thickness of the decking, the span of the decking, the type and pattern of the deck to frame fasteners (X-HSN24, X-EDNK22 or X-EDN19) and the type and spacing of the sidelap connectors (e.g. Hilti sidelap connectors S-SLC 01 and S-SLC 02).

For more details it is referred to the technical literature of Hilti North America (“Steel Deck Fastening Systems” – 2013 Supplement to Hilti North America Product Technical Guide) and the “Decking Design Center” offered on the website www.us.hilti.com as well as the respective approvals.

Recommended shear bearing loads V_{rec}

Sheeting thickness t_f		X-HSN24, X-EDNK22 and X-EDN19	
[Gauge]	[mm]	V_{rec} [lbs]	[kN]
22	0.76	500	2.20
20	0.91	600	2.64
18	1.21	785	3.45
16	1.52	975	4.29

- Valid for steel sheet with a minimum tensile strength of 45 ksi (310 N/mm²). Values refer to failure controlled by the single sheet metal attached.
- For intermediate sheet thicknesses, linear interpolation is allowed.
- Recommended loads include safety factor 3.0 applied to mean shear resistance Q_f . An equation for Q_f is published in the SDI (Steel Deck Institute) Diaphragm Design Manual, 3rd edition.

Recommended tension load N_{rec}

Sheeting thickness t_f		X-HSN24, X-EDNK22		X-EDN19	
[Gauge]	[mm]	N_{rec} [lbs]	[kN]	N_{rec} [lbs]	[kN]
22	0.76	355	1.56	340	1.52
20	0.91	435	1.95	340	1.52
18	1.21	435	1.95	340	1.52
16	1.52	435	1.95	340	1.52

- Valid for steel sheet with minimum tensile strength of 45 ksi (310 N/mm²). Values are either controlled by pull-over of sheet or by minimum value of fastener pullout of base metal.
- Values require fastener point penetration for X-EDNK22 and X-EDN19, of 1/2" (12.7 mm). Higher recommended values be applicable for X-HSN24 (see Hilti North America “Steel Deck Fastening Systems”)
- Recommended loads include a safety factor 3.0 applied to mean pullover resistance or a safety factor 5.0 applied to the mean value of pullout resistance.

Design data for use in Europe

Currently, the X-HSN24, X-EDNK22 and the X-EDN19 fasteners are only used in North America. Therefore, no design data is published evaluated in strict compliance with the provisions for European Technical Approvals.

For European markets, the fastener X-ENP2K-20 L15 in connection with the fastening tool DX 76 PTR is recommended for sheet metal fastenings to thin base materials (3 to 6 mm).

Application limits and requirements

Fastening tool DX 860-HSN

Fastener	Base material properties		Ultimate tensile strength	
	Thickness [inch]	[mm]	[ksi]	[N/mm ²]
X-EDNK22	1/8" to 1/4"	3.2 to 6.35	58 to 91	400–630
X-EDN19	3/16" to 5/16"	4.8 to 8.0	58 to 91	400–630
	5/16" to 3/8"	8.0 to 9.5	58 to 68	400–470

- Comment on fastening tool DX 460-SM: This fastening tool is recommended for base material thickness from 3/16" to 3/8" (4.8 to 8.0 mm). The same strength limits apply as with the DX 860-HSN.
- X-HSN24 covers full range of the fasteners X-EDNK22 and X-EDN19.

Thickness of fastened material, fastener patterns, spacings and edge distance

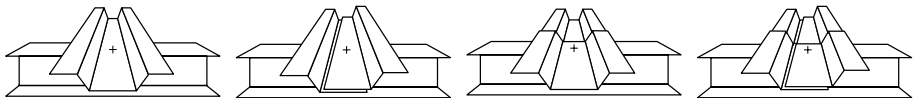

(a)
single

(b)
side lap

(c)
end overlap

(d)
side lap and end overlap

As part of a steel deck diaphragm, all four fastening types (a), (b), (c) and (d) are executed with the X-EDNK22 and the X-EDN19. The sheet metal thickness typically varies between 22 Gauge (0.76 mm) and 16 Gauge (1.52 mm).

Dependent on the base material thickness and the frame fastener pattern, restrictions on the use of thicker decking might apply. For corresponding details of these provisions, it is referred to the quoted technical literature published by Hilti North America. This literature also contains details with respect to fastener patterns, spacings and edge distance adequately addressing the specifics of the diaphragm components used in the North American market.

Corrosion information

The intended use only comprises fastenings which are not directly exposed to external weather conditions or moist atmospheres. For further detailed information on corrosion see relevant chapter in **Direct Fastening Principles and Technique** section.

Fastener selection and system recommendation

Fasteners	Designation	Item no.	Tool
Collated nails	X-HSN24	2042971	DX 860-HSN
	X-EDNK22 THQ12 M, grey magazine strip	34133	
	X-EDN19 THQ 12 M, white magazine strip	34134	

Cartridge selection and tool energy setting

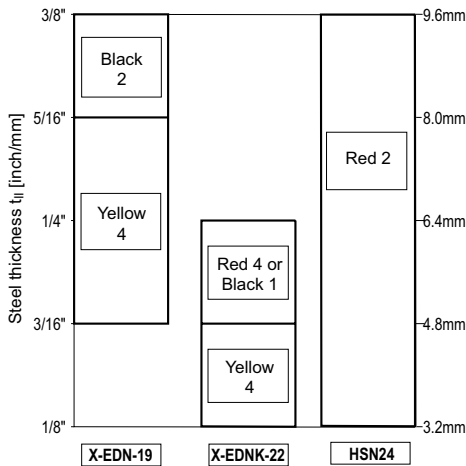

Fine adjustment by installation tests on site.

Fastening quality assurance

Fastening inspection

X-HSN 24

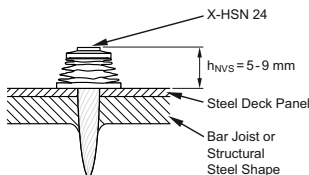

X-EDNK22 THQ12 / X-EDN19 THQ12

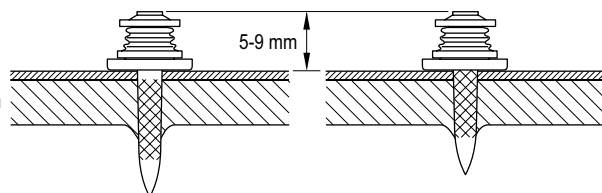

NPH siding and decking nails to concrete

Product data

Dimensions

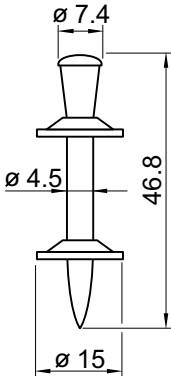

General information

Material specifications

Carbon steel shank:	HRC 58
Zinc coating:	8–16 µm

Recommended fastening tools:

	Cartridges:
DX 76 PTR	6.8/18M blue, yellow
with DX 76-F-Kwik-PTR	
fastener guide	
DX 76 with X-76-F-Kwik	
fastener guide	

See **Tools and equipment** for more details.

Approvals

SOCOTEC (France)
 BUTgb (Belgium)

Note:

Technical data presented in these approvals and design guidelines reflect specific local conditions and may differ from those published in this handbook.

Applications

Examples

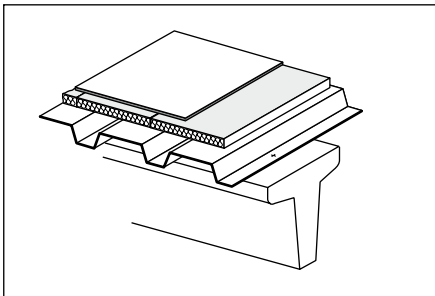

Roof decking

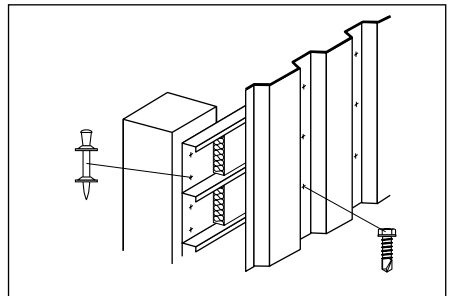

Wall liners

Load data

Recommended loads

Sheeting thickness t_f [mm] nominal	Trapezoidal profile (symmetric)		Liner trays (asymmetric)	
	N_{rec} [kN]	V_{rec} [kN]	N_{rec} [kN]	V_{rec} [kN]
0.75	1.80	1.20	1.30	1.20
0.88	2.10	1.50	1.50	1.50
1.00	2.40	1.80	1.70	1.80
1.13	2.70	2.20	1.90	2.20
1.25	3.00	2.50	2.10	2.50
1.50	3.00	3.00	2.50	3.00
1.75	3.00	3.00	2.50	3.00
2.00	3.00	3.00	2.50	3.00

- Recommended working loads valid for steel sheets with a minimum tensile strength of $\geq 360 \text{ N/mm}^2$.
- For intermediate sheet thicknesses, use recommended load for next smaller thickness.
- Recommended loads are appropriate for EC1 (or similar) wind loading designs.
- The safety factor included is at least 2.0 applied to the static 5 % fractile value and 1.3 to the cyclic (5000 cycles) 5 % fractile value.

Application requirements

Thickness of base material

Minimum thickness of concrete member

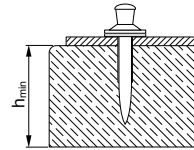
 $h_{min} = 160 \text{ mm}$ 

Thickness of fastened material

Sheet thicknesses and overlap types

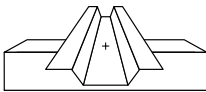
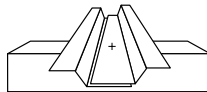
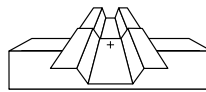
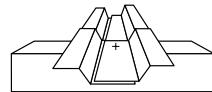
(a)
single(b)
side lap(c)
end overlap(d)
side lap and end overlap

Nominal sheeting thickness t_f [mm]	Allowable overlap types
0.63–1.13	a, b, c, d
> 1.13–2.50	a

- With the above recommended sheet thickness and overlap types, the effects of temperature induced forces of constraint during construction can be neglected.
- These recommendations are valid for sheets up to S350GD.
- With other sheets or overlaps or when unusually large forces of constraint are expected, analyse the structural system to ensure that the shear force acting on the nail does not exceed V_{rec} .

Spacing and edge distances (mm)

Trapezoidal profiles to girders or purlins

Liner trays to columns

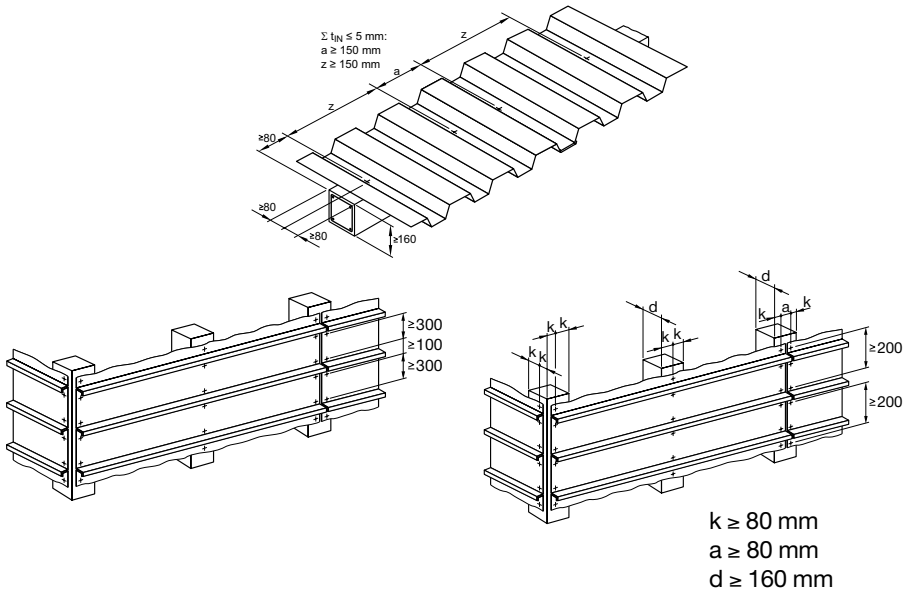

Corrosion information

The intended use only comprises fastenings which are not directly exposed to external weather conditions or moist atmospheres. For further detailed information on corrosion see relevant chapter in **Direct Fastening Principles and Technique** section.

Application limits

Types of concrete

- Precast and cast-in-place pre-stressed concrete
- Precast and cast-in-place reinforced concrete

Concrete design strength

- Minimum C20/25 ($f_c = 20 \text{ N/mm}^2$, $f_{cc} = 25 \text{ N/mm}^2$)
- Maximum C45/55 ($f_c = 45 \text{ N/mm}^2$, $f_{cc} = 55 \text{ N/mm}^2$)
- The **NPH/DX-Kwik** system has been successfully used in concrete having an in-place cube strength of 70 N/mm^2

Minimum strength/age at time of fastening

- C20/25 concrete must be 28 days old
- C45/55 concrete must be 15 days old

Minimum dimensions of concrete member

- Minimum width = 180 mm
- Minimum thickness = 160 mm

Fastener selection

Fasteners		Tool	Fastener guide	Piston
Designation	Item no.	Designation	Designation	Designation
NPH2-42 L15	40711	DX 76	X-76-F-Kwik	X-76-P-Kwik
		DX 76 PTR	X-76-F-Kwik-PTR	X-76-P-Kwik-PTR

Cartridge selection and tool energy setting

Cartridges 6.8/18 M blue

Tool energy adjustment by setting tests on site

Fastening quality assurance

Installation

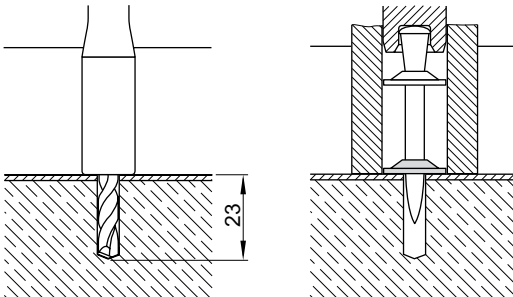

Pre-drill with TX-C-5/23 drill bit
(Item no.: 00061787)

Place fastener with DX 76 PTR
or DX 76

Fastening inspection

NPH2-42 L15

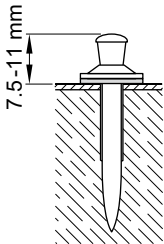

Check for conformity with recommendations
(detailing spacing and edge distances for fastening)

Check the nailhead standoff of completed fastenings

These are abbreviated instructions which may vary by application.

ALWAYS review/follow the instructions accompanying the product.

X-HVB shear connectors

Product data

Dimensions

X-HVB 140

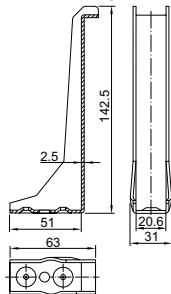

X-HVB 125

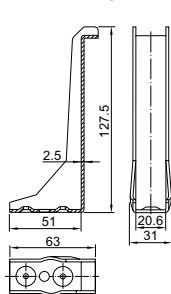

X-HVB 110

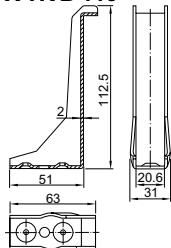

X-HVB 95

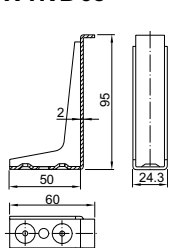

X-HVB 80

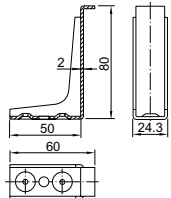

X-HVB 50

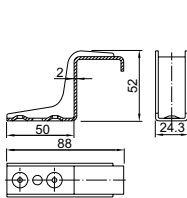

X-HVB 40

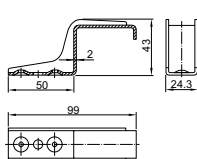

X-ENP-21 HVB

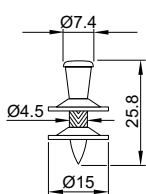

General information

Material specifications

X-HVB	
Carbon steel:	$R_m = 295\text{--}350 \text{ N/mm}^2$
Zinc coating:	$\geq 3 \mu\text{m}$
X-ENP-21 HVB	
Carbon steel shank:	HRC58
Zinc coating:	$8\text{--}16 \mu\text{m}$

Recommended fastening tools

Tool	DX 76	DX 76 PTR
Fastener guide	X-76-F-HVB	X-76-F-HVB-PTR
Piston	X-76-P-HVB	X-76-P-HVB-PTR
Cartridges	6.8/18M black, red (for details see application limit X-ENP-21 HVB)	

See **Tools and equipment** for more details.

Approvals and design guidelines

- SOCOTEC (France)
- DIBt (Germany)
- MLIT / BCJ (Japan),
- Rom. Ministry AT 016-01/214-2010 (Roma),
- TZÚS (Czech)

Note: technical data presented in these approvals and design guidelines reflect specific local conditions and may differ from those published in this handbook. If the fastening is subject to an approval process or where a design guideline must be used, technical data in the approval or design guideline has precedence over data presented here. Approval copies are available from your Hilti technical advisory service.

Applications

Examples

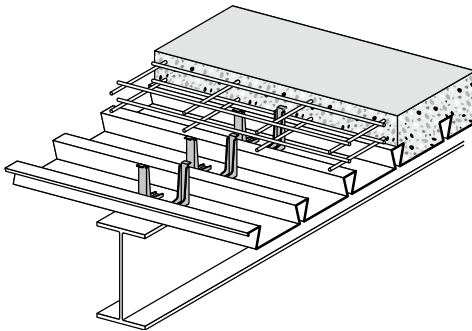

Typical application of X-HVB shear connector with steel deck, e.g. new construction.

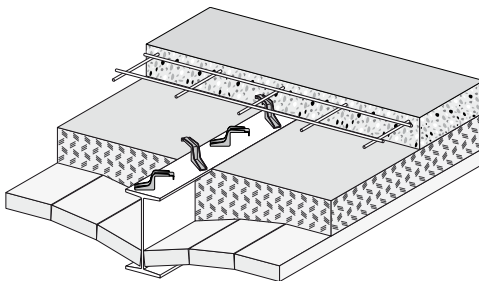

Typical application of X-HVB shear connector with jack arch system (without steel deck), e.g. rehabilitation project.

Design data

Designation	LWC ¹⁾ / NWC ²⁾	Characteristic shear resistance, P_{Rk} ³⁾	Design shear resistance, P_{Rd} ⁴⁾	Allowable horizontal shear ⁵⁾
X-HVB 40	LWC	25 kN	20 kN	N.A.
X-HVB 50	LWC	25 kN	20 kN	N.A.
X-HVB 40	NWC	28 kN	23 kN	N.A.
X-HVB 50	NWC	28 kN	23 kN	N.A.
X-HVB 80	NWC	28 kN	23 kN	14 kN
X-HVB 95	NWC	35 kN	28 kN	17.5 kN
X-HVB 110	NWC	35 kN	28 kN	17.5 kN
X-HVB 125	NWC	35 kN	28 kN	17.5 kN
X-HVB 140	NWC	35 kN	28 kN	17.5 kN

¹⁾ LWC: lightweight concrete with density of 1800kg/m³ and class L20-22

²⁾ NWC: normal weight concrete with density of 2400kg/m³ and class C20-25

³⁾ As defined in EN1994-1-1 (nominal strength in AISC-LRFD)

⁴⁾ As defined in EN 1994-1-1

⁵⁾ Allowable shear in AISC-ASD

Reduction factors for profile metal decks

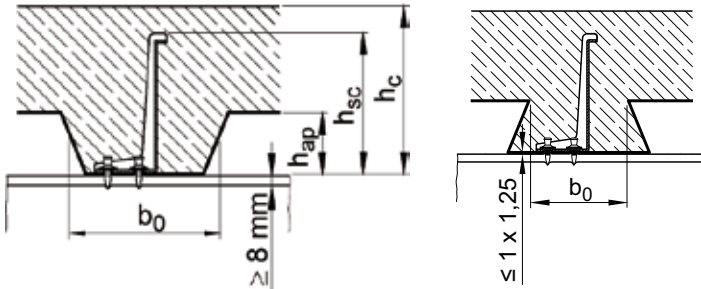

Ribs transverse to beams

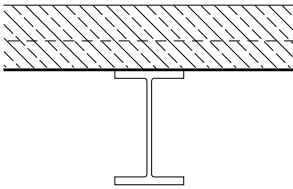

Note: $k_t \leq 1.0$

$$k_t = \frac{K}{\sqrt{N_r}} \cdot \frac{b_0}{h_{ap}} \cdot \frac{h_{sc} - h_{ap}}{h_{ap}}$$

EN 1994-1-1 designs:

$$K = 0.70$$

$N_r = \text{X-HVBs / rib} (\leq 2 \text{ in the calculation even if 3 are placed in a rib})$

AISC, CISC, BS 5950, other design codes:

$$K = 0.85$$

$N_r = \text{X-HVBs / rib} (1, 2 \text{ or } 3)$

Ribs parallel to beams

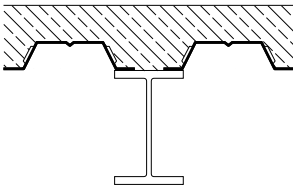

Note: $k_p \leq 1.0$

$$\text{for } \frac{b_0}{h_{ap}} \geq 1.8 \Rightarrow k_p = 1.0$$

$$\text{for } \frac{b_0}{h_{ap}} < 1.8 \Rightarrow k_p = 0.6 \times \frac{b_0}{h_{ap}} \cdot \frac{h_{sc} - h_{ap}}{h_{ap}}$$

Engineering advice

Connector placement along the beam

The X-HVB is a flexible connector and may be uniformly distributed between critical sections. These critical sections, where large changes in shear flow occur, may be at supporting points, points of application of point loads or areas with extreme bending moments.

Partial shear connection

Strength:

The minimum connection depends on the design code used:

- a) In **EN 1994-1-1** design, N/N_f must be at least 0.4. This increases depending on span length and decking geometry.
- b) In **AISC**, N/N_f must be at least 0.25.
- c) In **CISC**, N/N_f must be at least 0.50.

Deflection control only:

If the shear connection is needed for deflection control only, there is no minimum degree of connection. However, minimum allowable connector spacing applies and the steel beam must have enough strength to carry the self-weight and all imposed loads.

Application requirements

Thickness of base material

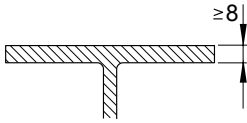

Minimum thickness of steel base material **$t_{II} = 8$ mm**

In rehabilitation projects, application to thin beam flanges of minimum 6 mm is possible in order to take the use of small I-sections (e.g. IAO 100 or IPN 80) into account. Please refer to Socotec approval or contact Hilti for detailed information.

Thickness of fastened material

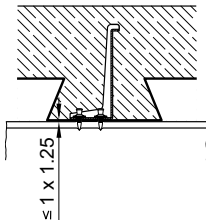

Maximum thickness of decking **$t_I = 1.25$ mm**

Connector positioning, spacing and edge distances

General positioning

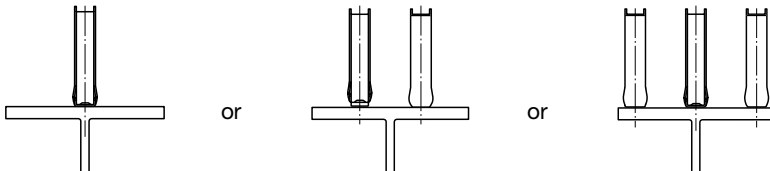

Position the X-HVBs so that the shear force is transferred symmetrically to the beam. X-HVB orientation parallel to the axis of the beam is preferred.

Positioning on metal decks - ribs transverse to beam

1) One, two or three X-HVBs per rib

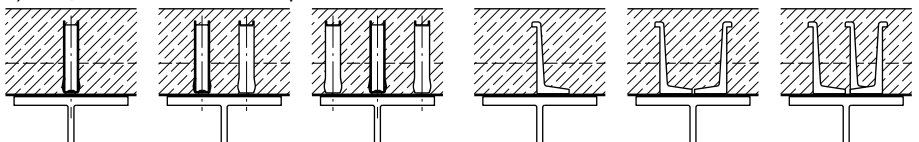

Parallel to beam

Perpendicular to beam

2a) Position in the rib : 1 X-HVB per rib – leg centred in the rib or 40 mm clearance



2b) With 2 or 3 X-HVBs per rib – legs centred in the rib or alternated about the center



3) Spacing along the ribs

- basic minimum spacing, $a \geq 50$ mm
- $a \geq 100$ mm for:
 - $b_o/m < 0.7$ and $b_o/h_{ap} < 1.8$
 - SDI 3" composite decking (USA)

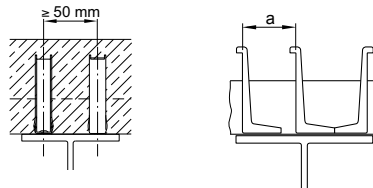

m = rib spacing

Positioning on solid slabs and metal decks – ribs parallel to beam

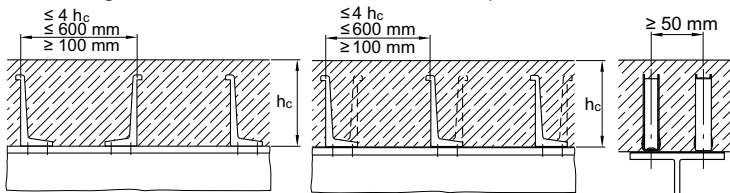

- With 1 connector per row, alternate direction of connectors from X-HVB to X-HVB.
- In case of multiple rows (parallel to the beam axis), X-HVBs must be placed with the same direction inside of each row and alternate from row to row.

Clearance to metal decking

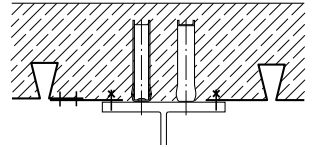
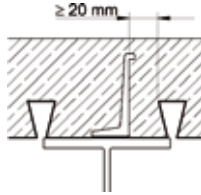
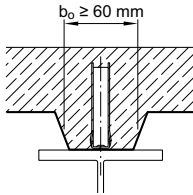

Split decking if necessary for spacing / clearance

Corrosion information

The intended use only comprises fastenings which are not directly exposed to external weather conditions or moist atmospheres.



Application limits

Application limits are valid only if correct cartridge and power setting are used!

Application limits X-ENP-21 HVB

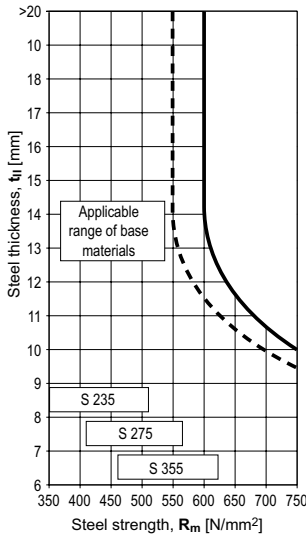

Cartridge preselection and power setting

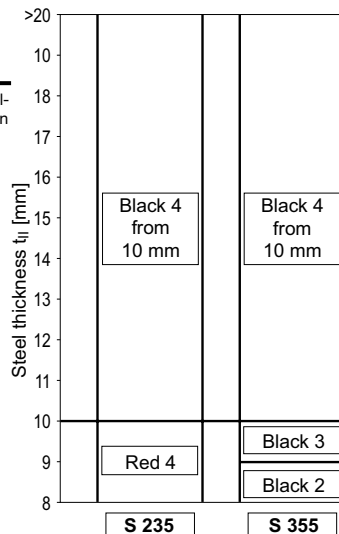

In thermo-mechanically rolled construction steel, e.g. S 355M per EN 10025-4 the application limit is reduced by 50 N/mm²

Fine adjustment by carrying out installation tests on site

Fastener selection

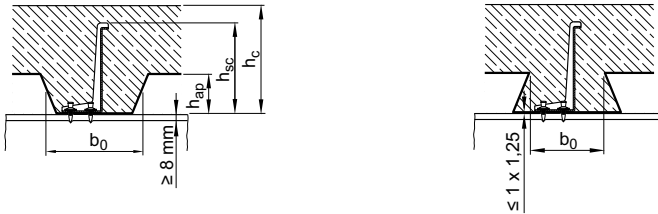

Connector

Designation	Item no.	Maximum decking height h_{ap} [mm]	
		$b_0 / h_{ap} \geq 1.8$	$b_0 / h_{ap} < 1.8$
X-HVB 40	2112256	Not for use with profiled decking	
X-HVB 50	56467	Not for use with profiled decking	
X-HVB 80	239357	45	45
X-HVB 95	348179	60	57
X-HVB 110	348180	75	66
X-HVB 125	348181	80	75
X-HVB 140	348321	80	80
All connectors with two nails			
X-ENP-21 HVB	283512		

Fastening quality assurance

Fastening inspection

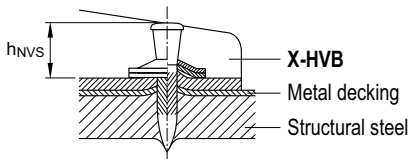

X-ENP-21 HVB $h_{NVS} = 8.2\text{--}9.8$ mm

X-U General Purpose Nails for Concrete and Steel

Product data

Dimensions

X-U_MX

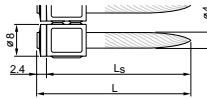

X-U __ P8

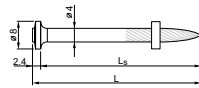

X-U __ P8 S36

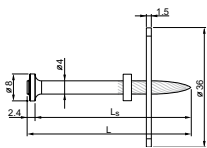

X-U __ P8 S15

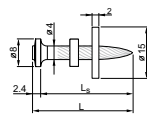

X-U 15 P8TH

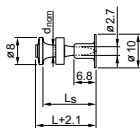

X-U __ S12

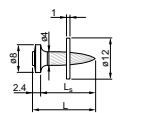

General information

Material specifications

Carbon steel shank: HRC 58
HRC 59 (X-U 15)
Zinc coating: 5–20 µm

Recommended fastening tools

See **X-U fastener program** in the next pages and **Tools and equipment** chapter for more details.

Approvals

ICC ESR-2269 (USA)
DIBt Z-14.4-517 (Germany)
ABS, LR 97/00077, IBBM 2006/2011

Note: technical data presented in these approvals and design guidelines reflect specific local conditions and may differ from those published in this handbook.

Applications

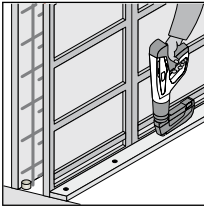

System formwork

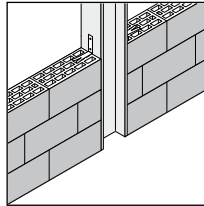

Wall-tie to steel and concrete

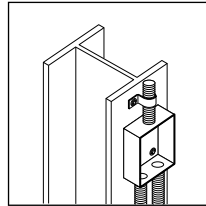

Mechanical and electrical fixtures

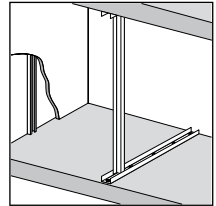

Drywall track to concrete and steel

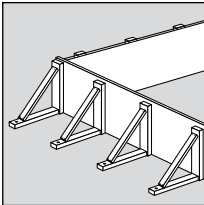

Conventional formwork

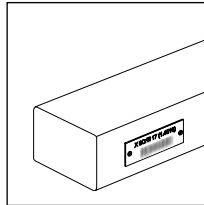

Tagging lables

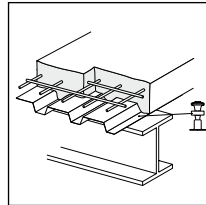

Tacking of metal decks

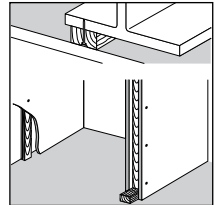

Sill plates / 2x4 wood to concrete and steel

The intended use for safety relevant and permanent applications only comprises fastenings which are not directly exposed to external weather conditions or moist atmospheres.

Fastening to Concrete

Recommended loads

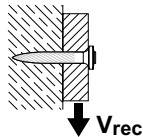
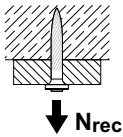

N_{rec} [kN]	V_{rec} [kN]	h_{ET} [mm]
0.4	0.4	≥ 27
0.3	0.3	≥ 22
0.2	0.2	≥ 18
0.1	0.1	≥ 14

Design conditions:

- For safety relevant fastenings sufficient redundancy of the entire system is required:
Minimum 5 fastenings per fastened unit.
- All visible failures must be replaced.
- Valid for concrete with strength of $f_{cc} \leq 45 \text{ N/mm}^2$.
- Valid for predominantly static loading.
- Failure of the fastened material is not considered in recommended loads
- To limit penetration of nail and to increase pull-over load, use nails with washers.

Fastening to Concrete

Application requirements

Thickness of base material

Concrete:

$h_{min} = 80 \text{ mm}$

Thickness of fastened material

Wood:

$t_f = 15\text{--}57 \text{ mm}$

Edge distance

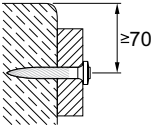

Edge distance: $c \geq 70 \text{ mm}$

Fastener selection and system recommendation

Fastening to concrete

Required nail shank length: $L_S = h_{ET} + t_f \text{ [mm]}$

Recommendation: $h_{ET} = 22 \text{ mm}$

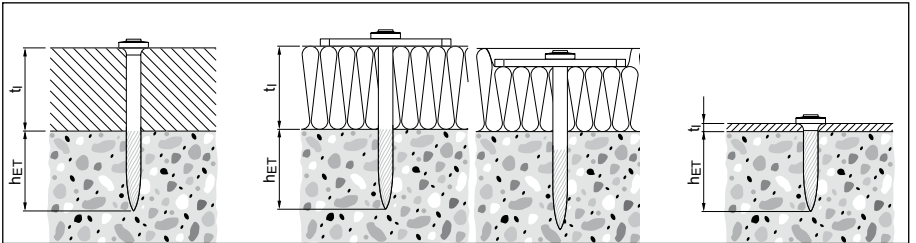

In case flush fastenings are required:

$L_S = h_{ET} + t_f - 5 \text{ [mm]}$

Cartridge recommendation

Tool energy adjustment by setting tests on site

Fastening to concrete: **6.8/11M yellow cartridge** on green/ fresh and standard concrete
6.8/11M red cartridge on precast, old and hard concrete

Fastening to Steel

Recommended loads

Fastening of steel sheets and other steel parts with X-U 16 and X-U 19

Recommended loads t_f [mm]	X-U_P8/MX N_{rec} [kN]	X-U_S12 N_{rec} [kN]	V_{rec} [kN]
0.75	1.0	1.4	1.2
1.00	1.2	1.8	1.8
1.25	1.5	2.2	2.6
≥ 2.00	2.0	2.2	2.6

Tacking of steel sheets with X-U 15

according to ECCS-recommendation N73, „Good Construction Practice for Composite Slabs

Recommended loads

t_f [mm]	N_{rec} [kN]	V_{rec} [kN]
0.75–1.25	0.6	0.8

Design conditions:

- Recommended working loads valid for steel sheet with minimum tensile strength $\geq 360 \text{ N/mm}^2$.
- For intermediate sheet thicknesses, use recommended load for next smaller thickness.
- In case of a design based on the characteristic resistance, recommended values have to be multiplied by two: $\Rightarrow N_{Rk} = N_{rec} \cdot 2.0$ $V_{Rk} = V_{rec} \cdot 2.0$
- For X-U 16 S12: base material thickness $t_{fI,min} = 8 \text{ mm}$ for $t_f \geq 1.5 \text{ mm}$ and $t_{fI,min} = 6 \text{ mm}$ for $t_f \leq 1.25 \text{ mm}$
- Other fastened parts: clips, brackets, etc.
- Redundancy (multiple fastening) must be provided.
- Valid for predominantly static loading

Forces of constraint

When fastening large pieces of steel, the possibility of shear loadings from forces of constraint should be considered. Avoid exceeding V_{rec} for the fastener shank!

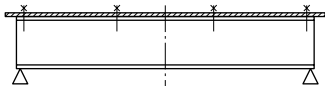

Deflection due to primary loading

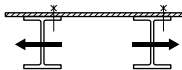

Temperature effect

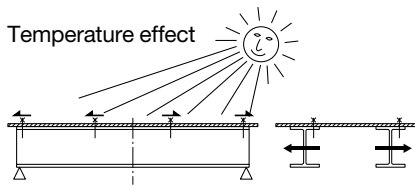
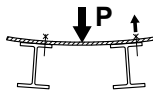
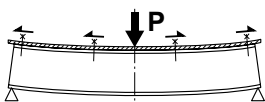

Fastening to Steel

Fastenings of wood to steel

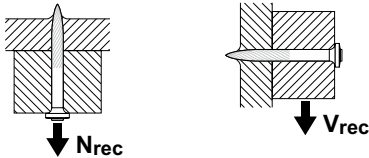

N_{rec} = 0.3 kN

V_{rec} = 0.6 kN

Design conditions:

- For safety-relevant fastenings sufficient redundancy of the entire system is required.
- In case soft material is fastened, its strength determines the loads.
- To limit penetration of nail and to increase pull-over load, use nails with washers.
- Observance of edge distance and fastener spacing in compliance with recognized standards EN 1995 (see approval).
- With respect to details of fastening wood, chipboard or OSB members to steel base material, it is referred to the German approval DIBt Z-14.4-517.

Application requirements

Thickness of base material

Steel:

t_{II} ≥ 6.0 mm (fastening steel to steel)

t_{II} ≥ 4.0 mm (fastening wood to steel)

Thickness of fastened material

Steel:

t_I ≤ 3 mm (fastened material not pre-drilled)

3 mm < t_I ≤ 6 mm (fastened material pre-drilled)

Wood:

t_I = 15–57 mm

Condition for thick fastened steel parts (3 mm < t_I ≤ 6 mm)

If a gap between the fastened part and the base material is unacceptable, the fastened part needs to be prepared with drilled holes.

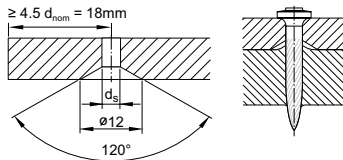

Edge distance and spacing

Rolled shapes:

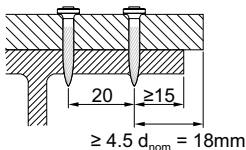

Edge distance: c ≥ 15 mm

Spacing: a = 20 mm

Fastening to Steel

Application limits

Fastening of steel sheets and steel parts to steel

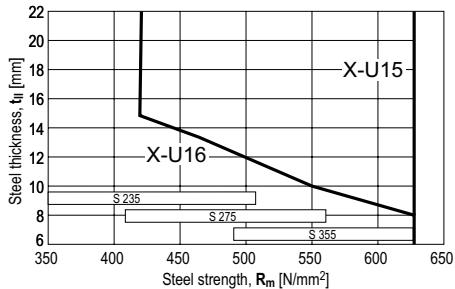

X-U 16 P8, X-U 15 P8TH: For steel sheeting with $0.75 \text{ mm} \leq t_1 \leq 1.25 \text{ mm}$ sheets

Fastening of wood and soft material to steel

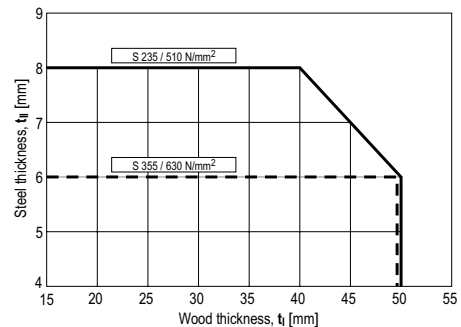

For X-U 22 P8 to X-U 62 P8

Fastener selection and system recommendation

Required nail shank length: $L_S = h_{ET} + t_1$ [mm]

Fastening steel to steel

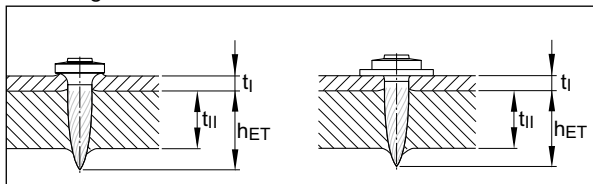

Recommendation: $h_{ET} = 12 \pm 2 \text{ mm}$

Fastening wood to steel

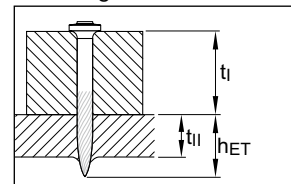

$h_{ET} \geq 8 \text{ mm}$

Cartridge recommendation

Tool energy adjustment by setting tests on site

Fastening wood to steel: 6.8/11M green or yellow cartridge

on steel thickness $t_{1l} < 6 \text{ mm}$

6.8/11M yellow, red or black cartridge

on steel thickness $t_{1l} \geq 6 \text{ mm}$

Fastening steel to steel: 6.8/11M cartridge

Fastening to Steel

X-U 16

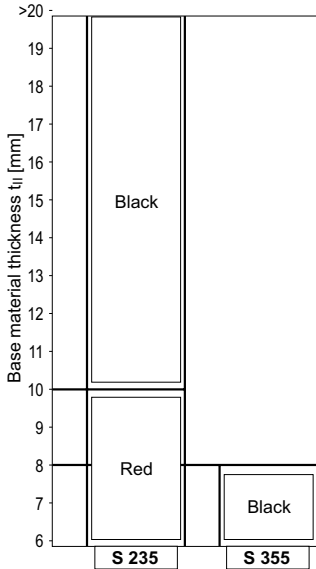

X-U 15 P8TH

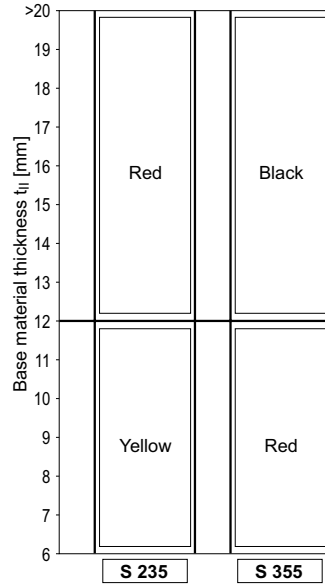

Fastening quality assurance

Fastening inspection

X-U __ P8/MX

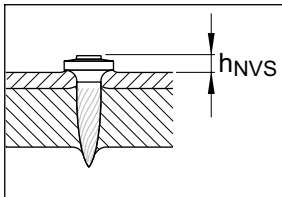

$h_{NVS} = 2.5-4.5 \text{ mm}$

X-U __ S12

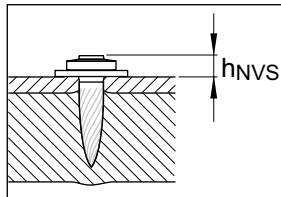

$h_{NVS} = 4.0-5.5 \text{ mm}$

X-U _ P8TH / MXSP

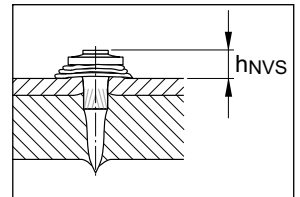

$h_{NVS} = 4.0-6.0 \text{ mm}$

Fastener program

Fastener	Item no.	L _s [mm]	Standard tools					Special tools			Key applications
			DX 460 MX	DX 460 F8	DX 36, DX 2	DX E72	DX 351 MX	DX 351 F8	DX 35	DX 462 F8	
X-U 16 MX	237344	16	■				■				Sheet metal on steel
X-U 19 MX	237345	19	■				■				Sheet metal on steel
X-U 22 MX	237346	22	■				■				Wood on concrete/steel
X-U 27 MX	237347	27	■				■				Wood on concrete/steel
X-U 32 MX	237348	32	■								Wood on concrete/steel
X-U 37 MX	237349	37	■								Wood on concrete/steel
X-U 42 MX	237350	42	■								Wood on concrete/steel
X-U 47 MX	237351	47	■								Wood on concrete/steel
X-U 52 MX	237352	52	■								Wood on concrete/steel
X-U 57 MX	237353	57	■								Wood on concrete/steel
X-U 62 MX	237354	62	■								Wood on concrete/steel
X-U 72 MX	237356	72	■								Wood on concrete/steel
X-U 16 P8	237330	16		■	■	■		■	■	■	Sheet metal on steel
X-U 19 P8	237331	19		■	■	■		■	■	■	Sheet metal on steel
X-U 22 P8	237332	22		■	■	■		■	■	■	Wood on concrete/steel
X-U 27 P8	237333	27		■	■	■		■	■	■	Wood on concrete/steel
X-U 32 P8	237334	32		■	■	■		■	■	■	Wood on concrete/steel
X-U 37 P8	237335	37		■	■	■		■	■	■	Wood on concrete/steel
X-U 42 P8	237336	42		■	■	■		■	■	■	Wood on concrete/steel
X-U 47 P8	237337	47		■	■	■		■	■	■	Wood on concrete/steel
X-U 52 P8	237338	52		■	■	■			■	■	Wood on concrete/steel
X-U 57 P8	237339	57		■	■	■			■	■	Wood on concrete/steel
X-U 62 P8	237340	62		■	■	■					Wood on concrete/steel
X-U 72 P8	237342	72		■	■	■					Wood on concrete/steel
X-U 16 P8TH	237329	16		■	■	■		■	■	■	Sheet metal on steel, *)
X-U 19 P8TH	385781	19		■	■	■		■	■	■	Sheet metal on steel, *)
X-U 27 P8TH	385782	27		■	■	■		■	■	■	Sheet metal on concrete, *)
X-U 15 MXSP	383466	16	■				■				Sheet metal on steel
X-U 15 P8TH	237328	16		■	■	■		■	■	■	Sheet metal on steel

*) firm hold down

Fastener	Item no.	L _S [mm]	Standard tools						Special tools			Key applications
			DX 460 MX	DX 460 F8	DX 36, DX 2	DX E72	DX 351 MX	DX 351 F8	DX 35	DX 462 F8	DX 460 F8S12 / DX 462 F8S12	
X-U 27 P8S15	237371	27	■	■	■			■	■	■	High pull-over strength	
X-U 32 P8S15	237372	32	■	■	■			■	■	■	High pull-over strength	
X-U 32 P8S36	237374	32	■	■	■			■	■	■	Soft material on concr./steel	
X-U 52 P8S36	237376	52	■	■	■			■		■	Soft material on concr./steel	
X-U 72 P8S36	237379	72	■	■	■						Soft material on concr./steel	
X-U 16 S12	237357	16								■	High pull-over strength	
X-U 19 S12	237358	19								■	High pull-over strength	
X-U 22 S12	237359	22								■	High pull-over strength	
X-U 27 S12	237360	27								■	High pull-over strength	
X-U 32 S12	237361	32								■	High pull-over strength	

■ = Recommended

■ = Feasible

X-C Nails for Concrete and Sand-lime-Masonry

Product data

Dimensions

X-C __ P8

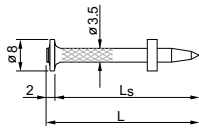

X-C __ MX

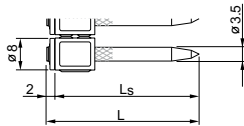

X-C __ P8S23

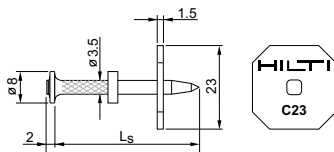

General information

Material specifications

Carbon steel shank: HRC 56.5
HRC 58 *)

Zinc coating: 5–20 μm

*) X-C 82, 97 and 117 P8 ($d_{nom} = 3.7$ mm)

Recommended fastening tools

See **X-C fastener program** in the next pages and **Tools and equipment** chapter for more details.

X-C __ P8S23T (for tunneling applications)

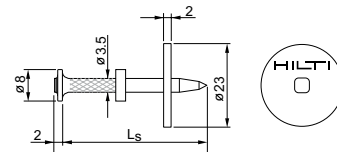

X-C __ P8S36

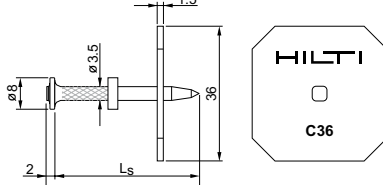

Applications

Examples

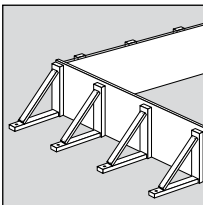

Conventional Formwork

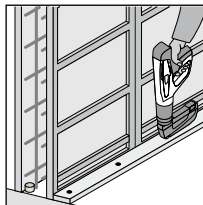

System Formwork

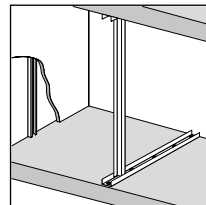

Drywall track to concrete



Load data

Recommended loads

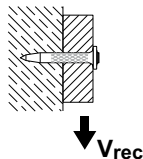
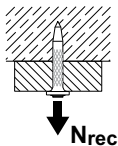

Fastening wood to concrete:

N_{rec} [kN]	V_{rec} [kN]	h_{ET} [mm]
0.4	0.4	≥ 27
0.3	0.3	≥ 22
0.2	0.2	≥ 18
0.1	0.1	≥ 14

Fastenings to sandlime masonry:

$N_{rec} = V_{rec} = 0.4 \text{ kN}$ for $h_{ET} \geq 27 \text{ mm}$

Design conditions:

- For safety relevant fastenings sufficient redundancy of the entire system is required: minimum 5 fastenings per fastened unit.
- All visible failures must be replaced.
- Valid for concrete with strength of $f_{cc} < 45 \text{ N/mm}^2$.
- Valid for predominantly static loading.
- Failure of the fastened material is not considered in recommended loads.
- To limit penetration of nail in soft material and to increase pullover load, use nails with washers.

Application requirements

Thickness of base and fastened material

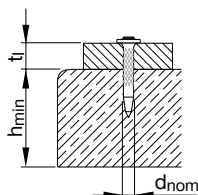

Concrete

$h_{min} = 80 \text{ mm}$

$t_b \leq 50.0 \text{ mm}$

Edge distances [mm]

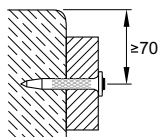

$c \geq 70 \text{ mm}$

Corrosion information

The intended use for safety relevant and permanent applications only comprises fastenings which are not directly exposed to external weather conditions or moist atmospheres.

Fastener selection and system recommendation

Fastener selection

Required nail shank length:

$L_S = h_{ET} + t_f$ [mm]

Recommendation:

Concrete **$h_{ET} = 22$ mm**

Sandlime masonry **$h_{ET} = 27$ mm**

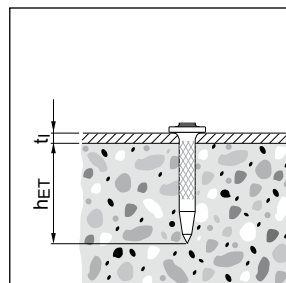
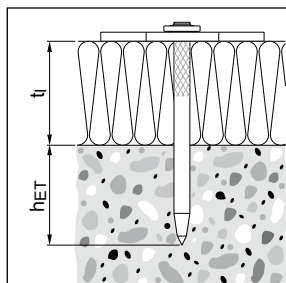
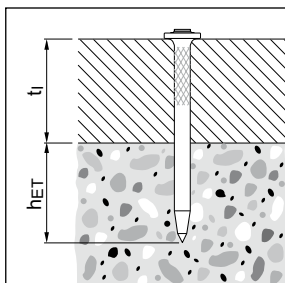

In case flush fastenings are required:
 $L_S = h_{ET} + t_f - 5$ [mm]



Fastener program

Nails					Tools							Key applications
Fastener description	Item no.		Specification		DX 460 MX	DX 460 F8	DX 2	DX E72 / DX 36	DX 351 MX	DX 351 F8	DX 35	
	Packs of 1000 pcs	Packs of 100 pcs	L _s (mm)	d _{nom} (mm)								
X-C 22 P8	2091378	2091377	22	3.5	■	■	■			■	■	Thin metal part to concrete
X-C 27 P8	2091380	2091379	27	3.5	■	■	■			■	■	Thin metal part to concrete
X-C 32 P8	2091382	2091381	32	3.5	■	■	■			■	■	Thin metal part to concrete
X-C 37 P8	2091384	2091383	37	3.5	■	■	■			■	■	Thin metal part to concrete
X-C 42 P8	2091386	2091385	42	3.5	■	■	■			■		Soft mat / Wood on concrete
X-C 47 P8	2091388	2091387	47	3.5	■	■	■			■	■	Soft mat / Wood on concrete
X-C 52 P8	2091390	2091389	52	3.5	■	■	■					Wood on concrete
X-C 62 P8	2091392	2091391	62	3.5	■	■	■					Wood on concrete
X-C 72 P8		2091393	72	3.5	■	■	■					Wood on concrete
X-C 82 P8		360930	82	3.7	■		■					Wood on concrete
X-C 97 P8		360931	97	3.7	■		■					Wood on concrete
X-C 117 P8		360933	117	3.7	■		■					Wood on concrete
X-C 20 THP	2091373	2091372	20	3.5	■	■	■			■	■	Thin metal part to concrete
X-C 22 P8 S15TH		2091410	22	3.5	■	■	■					Thin metal part to concrete
X-C 22 P8TH	2091374	2091375	22	3.5	■	■	■			■	■	Thin metal part to concrete
X-C 27 P8TH		2091376	27	3.5	■	■	■			■	■	Thin metal part to concrete
X-C 27 P8S23	2091396	2091395	27	3.5	■	■	■			■	■	High pull-over strength on concrete
X-C 32 P8S23	2091399	2091397	32	3.5	■	■	■			■	■	High pull-over strength on concrete
X-C 37 P8S23	2091401	2091400	37	3.5	■	■	■			■	■	High pull-over strength on concrete
X-C 42 P8S23	2091404	2091403	42	3.5	■	■	■			■		High pull-over strength on concrete
X-C 47 P8S23	2091406	2091405	47	3.5	■	■	■			■		High pull-over strength on concrete
X-C 37 P8S36	2091407		37	3.5	■	■	■			■	■	High pull-over strength on concrete
X-C 52 P8S36	2091408		52	3.5	■	■	■			■		High pull-over strength on concrete
X-C 62 P8S36	2091409		62	3.5	■	■	■					High pull-over strength on concrete
X-C 32 P8S23T	2091398		32	3.5	■	■	■					Tunneling applications
X-C 37 P8S23T	2091402		37	3.5	■	■	■					Tunneling applications

■ recommended

■ feasible

Nails					Tools							Key applications
Fastener description	Item no.		Specification		DX 460 MX	DX 460 F8	DX 2	DX E72 / DX 36	DX 351 MX	DX 351 F8	DX 35	
	Packs of 1000 pcs	Packs of 100 pcs	L _s (mm)	d _{nom} (mm)								
X-C 20 MX	2091264	2091265	20	3.5	■							Thin metal part to concrete
X-C 27 MX	2091266	2091267	27	3.5	■				■			Thin metal part to concrete
X-C 32 MX	2091268	2091269	32	3.5	■							Thin metal part to concrete
X-C 37 MX	2091360	2091361	37	3.5	■							Thin metal part to concrete
X-C 42 MX	2091362	2091363	42	3.5	■							Soft material / Wood on concrete
X-C 47 MX	2091364	2091365	47	3.5	■							Soft material / Wood on concrete
X-C 52 MX	2091366	2091367	52	3.5	■							Wood on Concrete
X-C 62 MX	2091368	2091369	62	3.5	■							Wood on Concrete
X-C 72 MX	2091370	2091371	72	3.5	■							Wood on Concrete

MX: collated nails for magazine

■ recommended

Cartridge recommendation:

Green concrete: **6.8/11M green**

Normal concrete: **6.8/11M yellow**

Old/high strength concrete: **6.8/11M red**

Sandlime masonry: **6.8/11M green**

Tool energy adjustment by setting tests on site.

X-S Drywall Fasteners to Steel

Product data

Dimensions

X-S13 THP

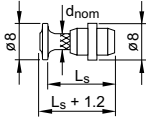

X-S 16 P8TH

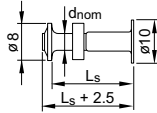

General information

Material specifications

Carbon steel shank:

X-S 16 P8 TH HRC 55.5

X-S 13 THP/MX HRC 52.5

Zinc coating: 5–13 µm

Recommended fastening tools

DX 460, DX 460 MX, DX 36, DX 2, DX 351, DX 351 MX, DX-E 72

See **X-S fastener program** in the next pages and **Tools and equipment** chapter for more details.

Approvals

ICC (USA): **X-S (ESR-1752)**

Note: technical data presented in these approvals and design guidelines reflect specific local conditions and may differ from those published in this handbook.

Applications

Examples

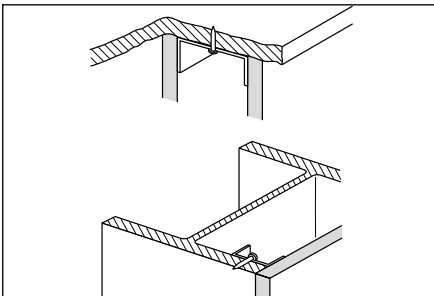

Drywall tracks to steel

Load data

Recommended loads

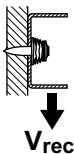
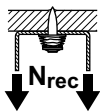

Steel 0.4 kN

Design conditions:

- Redundancy (multiple fastening) must be provided
- All visible failures must be replaced

Application requirements

Thickness of base material

Steel

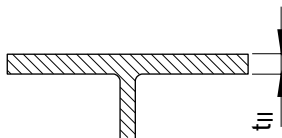

$t_{II} \geq 3 \text{ mm}$

Thickness of fastened material

Wooden track: $t_I \leq 24 \text{ mm}$

Metal track: $t_I \leq 2 \text{ mm}$

Edge distance

$c \geq 15 \text{ mm}$

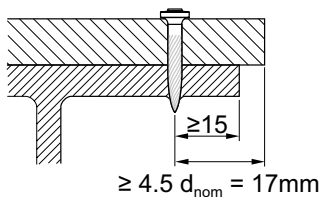

Corrosion information

The intended use only comprises fastenings which are not directly exposed to external weather conditions or moist atmospheres. For further detailed information on corrosion see corresponding chapter in **Direct Fastening Principles and Technique** section.

Application limits

Steel

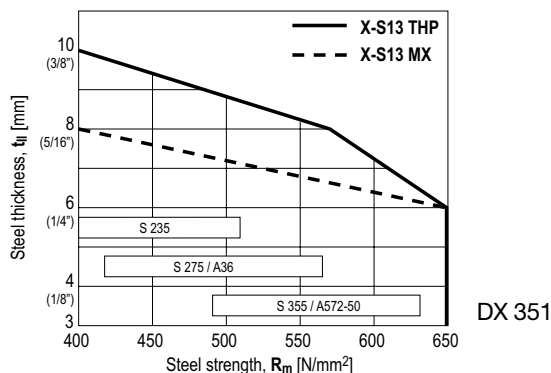

Fastener selection and system recommendation

Fastener selection

	Application	Base material
X-S 16	Metal track	Steel
X-S 13	Metal track	Steel

↑
↑ increases
↑ strength
↓
↓ burrs/cracks

Fastener program

Fastener	Item no. Packs of 1000 nails	Item no. Packs of 100 nails	L_S [mm]	d_{nom} [mm]	Standard tools						
					DX 460 MX	DX 460 F8	DX 36, DX 2	DX E72	DX 351 MX	DX 351 F8	DX 35
X-S 13 THP	274061	274059	13	3.7		■	■	■		■	■
X-S 16 P8 TH	388842		16	3.7		■	■	■		■	■
X-S 13 MX	274062	274060	13	3.7	■					■	

Cartridge selection and tool energy setting

Cartridge recommendation:

6.8/11M yellow or red cartridge on steel thickness $t_{II} \geq 6$ mm

6.8/11M green or yellow cartridge on steel thickness $t_{II} < 6$ mm

Tool energy adjustment by setting tests on site.

Fastening quality assurance

Fastening inspection

Fastening to steel

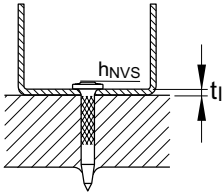

X-S: $h_{NVS} = 2-4$ mm

X-EGN, X-GHP, X-GN: GX Fasteners

Product data

Dimensions

X-EGN 14

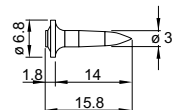

X-GHP 16/18/20/24

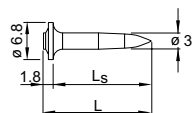

X-GN 20/27/32

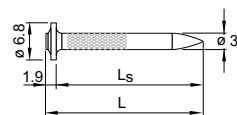

X-GN 39

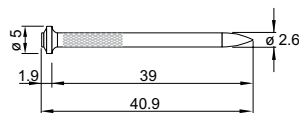

General information

Material specifications

Carbon steel shank:	X-EGN	HRC 58
	X-GHP	HRC 58
	X-GN	HRC 53.5
Zinc coating:	2–13 μm	

Recommended fastening tools

GX 120, GX 120-ME

GX 100, GX 100 E

See X-EGN, X-GHP, X-GN fastener program in the next pages and Tools and equipment chapter for more details.

Approvals

ICC-ESR 1752 (USA):	X-GN 20/27/32, X-EGN 14, X-GHP 16/18/20/24
IBMB	X-GHP, X-GN

Note: technical data presented in these approvals and design guidelines reflect specific local conditions and may differ from those published in this handbook.

Applications

Examples

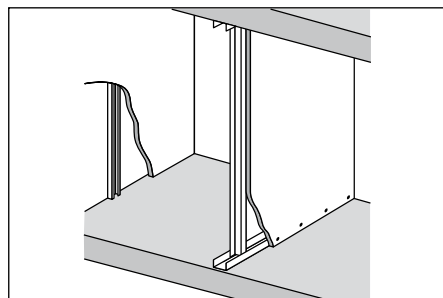

Drywall tracks to concrete and steel



Electrical applications

Load data

Recommended loads

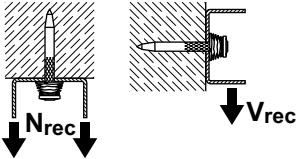

Design conditions:

- Minimum 5 fastenings per fastened unit
- All visible failures must be replaced

Concrete

N_{rec} [kN]	V_{rec} [kN]	h_{ET} [mm]
0.4	0.4	≥ 27
0.3	0.3	≥ 22
0.2	0.2	≥ 18
0.1	0.1	≥ 14

Steel

$$N_{rec} = V_{rec} = 0.4 \text{ kN}$$

Application requirements

Thickness of base material

Concrete

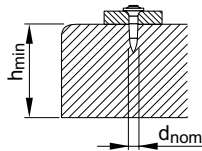

$$h_{min} = 60 \text{ mm}$$

$$(d_{nom} = 3.0 \text{ mm})$$

Steel

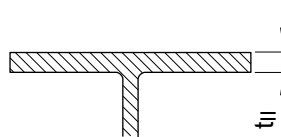

$$t_{II} \geq 4 \text{ mm}$$

Thickness of fastened material

- Wooden track: $t_I \leq 24 \text{ mm}$
 Metal track: $t_I \leq 2 \text{ mm}$

Spacing and edge distances (mm)

Spacing along track
(as per U.S. Gypsum Handbook)

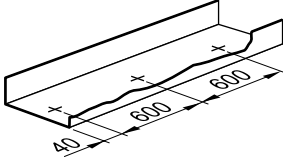

All track ends (cut-outs for doors),
secure with 2 nails

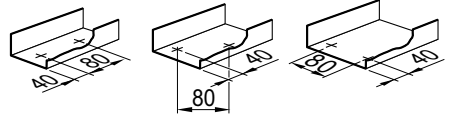

Distance to edge of concrete /
sandlime masonry

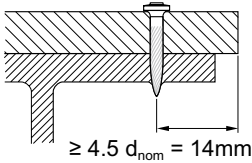
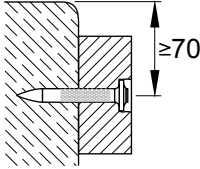

Fastener spacings on wood:

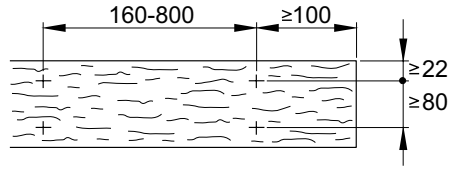

Corrosion information

The intended use only comprises fastenings which are not directly exposed to external weather conditions or moist atmospheres. For further detailed information on corrosion see relevant chapter in **Direct Fastening Principles and Technique** section.

Application limits

Steel

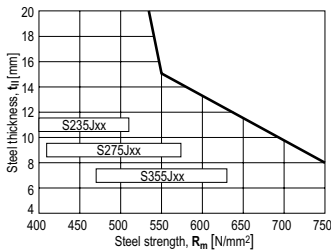

X-EGN 14

Fastener selection and system recommendation

Fastener selection

Fastening to concrete / sandlime masonry

	Application	Base material	
X-GN 39 MX	Wooden track ($t_f \leq 24$ mm)	Concrete/sandlime masonry	 Increasing strength
X-GN 27MX	Metal track	Concrete/sandlime masonry	
X-GN 20 MX	Metal track	Concrete/sandlime masonry	
X-GHP_MX	Metal track	Concrete/sandlime masonry	

Fastening to steel

	Application	Base material
X-EGN 14	Metal track	Steel

Fastener program

	Item no.	L_s [mm]	L [mm]	d_{nom} [mm]
X-EGN 14 MX	340231	14	15.8	3.0
X-GHP 16 MX	2071471	16	17.8	3.0
X-GHP 18 MX	340228	18	19.8	3.0
X-GHP 20 MX	285724	20	21.8	3.0
X-GHP 24 MX	438945	24	25.8	3.0
X-GN 20 MX	340232	19	20.9	3.0
X-GN 27 MX	340230	27	28.9	3.0
X-GN 32 MX	340233	32	33.9	3.0
X-GN 39 MX	340234	39	40.9	2.6

Tool and gas can

Designation

GX 120 / GX 120 ME

with gas can GC 20, GC 21 and GC 22

GX 100 / GX 100 E

with gas can GC 11 and GC 12 (for USA)

Fastening quality assurance

Fastening inspection

Fastening to concrete / sandlime masonry

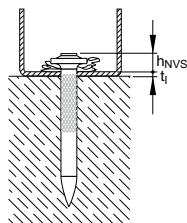

X-GN/GHP: $h_{NVS} = 2-5$ mm

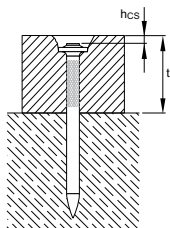

X-GN 39: $h_{CS} = 2-3$ mm

Fastening to steel

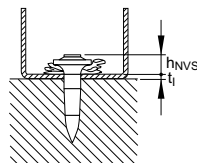

X-EGN 14: $h_{NVS} = 4-7$ mm



DS Heavy Duty General Purpose Nails for Concrete and Steel

Product data

Dimensions

DS __ P10

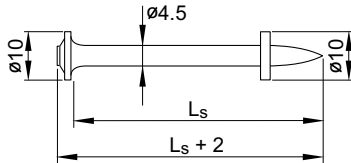

General information

Material specifications

Carbon steel shank: HRC 54 (**DS**)
 HRC 58 (**DSH**)
 Zinc coating: 5–20 µm

Recommended fastening tools

DX 460, DX 76, DX 76 PTR

See **DS fastener program** in the next pages and **Tools and equipment** chapter for more details

Approvals

ICC (USA) LR 97/00077

Note:

Technical data presented in these approvals and design guidelines reflect specific local conditions and may differ from those published in this handbook.

Applications

Examples

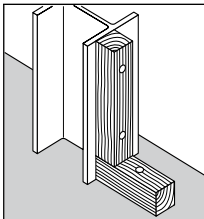

Wood to steel and concrete

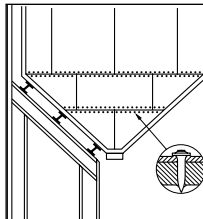

Plastic and rubber to steel

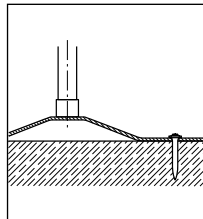

Metal parts to concrete

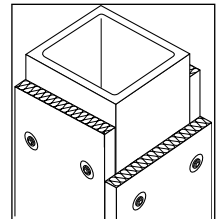

Soft material to steel and concrete

Load data

Recommended loads

Fastening wood to concrete, sandlime masonry or steel

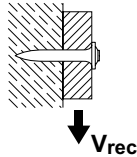
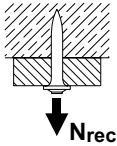

Fastening wood to concrete, sandlime masonry:

$$N_{rec} = V_{rec} = 0.4 \text{ kN}$$

Fastening wood to steel:

$$N_{rec} = V_{rec} = 0.6 \text{ kN}$$

Design conditions:

- For safety-relevant fastenings sufficient redundancy of the entire system is required: minimum 5 fastenings per fastened unit with normal weight concrete base material.
- All visible failures must be replaced.
- Valid for concrete and sandlime masonry with strength of $f_{cc} < 40 \text{ N/mm}^2$.
- Fastened material: wood, minimum thickness = 24 mm
plywood, minimum thickness = 16 mm

Soft material:

- Working loads depend on strength and thickness of material fastened. Do not use working loads in excess of those for wood.
- Depth of penetration and other conditions same as for fastening wood.
- Use R23 or R36 ($\varnothing 4.5 \text{ mm}$ hole) washer to control penetration and to increase pull-over strength. Separately available from Hilti.

Metal profiles to concrete:

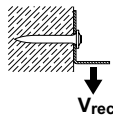
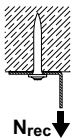

$$N_{rec} = V_{rec} = 0.4 \text{ kN}$$

- Minimum 5 fastenings per fastened unit (normal weight concrete)
- Increase to 600 N possible if 8 or more fastenings in each fastened unit.
- All visible failures must be replaced
- $t_f = 1\text{--}4 \text{ mm}$

Application requirements

Thickness of base material

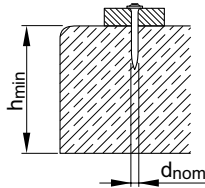

Concrete

$h_{min} = 100 \text{ mm}$ ($d_{nom} \geq 4.5 \text{ mm}$)

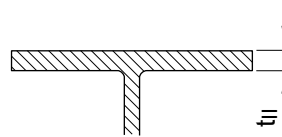

Steel

$t_l \geq 6 \text{ mm}$

Thickness of fastened material

$t_l \leq 50.0 \text{ mm}$

Spacing and edge distances (mm)

Edge distance: concrete

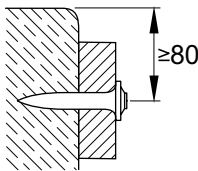

Edge distance: steel

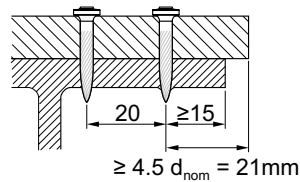

Spacing

$a = 20 \text{ mm}$

Corrosion information

The intended use for safety-relevant and permanent applications only comprises fastenings which are not directly exposed to external weather conditions or moist atmospheres. For further detailed information on corrosion see relevant chapter in **Direct Fastening Principles and Technique** section.

Application limits

Steel

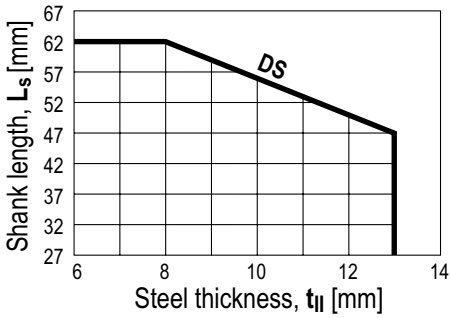

Fastener selection

Fastening to concrete

Required nail shank length:

Wood or

metal profiles $L_S = h_{ET} + t_I$ [mm]

Soft material $L_S = h_{ET} + t_I - 2 - h_{CS}$ [mm]

$h_{CS} \approx 3$ mm if possible

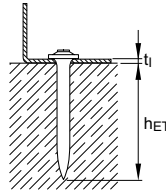

Required depth of penetration h_{ET}

Select h_{ET}

$h_{ET} \geq 27$ mm

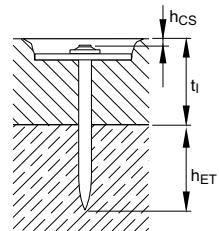
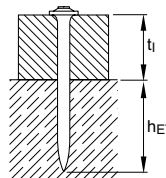

Fastening to steel

$h_{ET} = 17-27$ mm

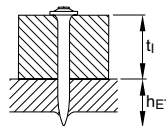

Fastener program

Fasteners				Tool ¹⁾
Designation	Item no.	L _S [mm]	d _{nom} [mm]	Designation
DS 27 P10	46157	27	4.5	DX 460, DX 76, DX 76 PTR
DS 32 P10	46158	32	4.5	DX 460, DX 76, DX 76 PTR
DS 37 P10	46159	37	4.5	DX 460, DX 76, DX 76 PTR
DS 42 P10	46160	42	4.5	DX 460, DX 76, DX 76 PTR
DS 47 P10	46161	47	4.5	DX 460, DX 76, DX 76 PTR
DS 52 P10	46162	52	4.5	DX 460, DX 76, DX 76 PTR
DSH 57 P10	40591	57	4.5	DX 460, DX 76, DX 76 PTR
DS 62 P10	46164	62	4.5	DX 460, DX 76, DX 76 PTR
DS 72 P10	46165	72	4.5	DX 460, DX 76, DX 76 PTR

¹⁾ Nail length limits are for use without pre-driving into the wood. Hand-driving the nail into the wood and bringing the DX tool into position over the nail head extend the nail length range for the tools.

Cartridge selection and tool energy setting

Cartridge recommendation: DX 460

Steel: **6.8/11M red cartridge**

Concrete: **6.8/11M yellow or red cartridge**

Masonry: **6.8/11M green cartridge**

Cartridge recommendation: DX 76, DX 76 PTR

Steel: **6.8/18M red or black cartridge**

Concrete: **6.8/18M yellow or red cartridge**

Tool energy adjustment by setting tests on site.

Fastening quality assurance

Fastening inspection

Fastening wood or soft material

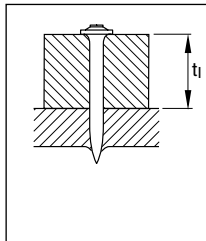
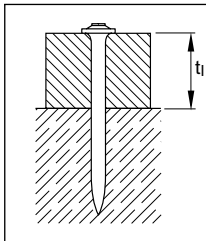

Fastening metal profiles

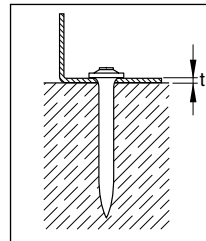

Flush setting of the nails

EDS Nails for Fastening Steel to Steel

Product data

Dimensions

EDS_P10

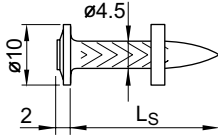

General information

Material specifications

Carbon steel shank:

EDS 19/22 HRC 55.0

EDS 27 HRC 53.5

Zinc coating: 10–25 μm

Recommended fastening tools

DX 76, DX 76 PTR

See **EDS fastener program** in the next pages and **Tools and equipment** chapter for more details.

Approvals

ICC (USA)

ABS & LR

Note:

Technical data presented in these approvals and design guidelines reflect specific local conditions and may differ from those published in this handbook.



Applications

Example

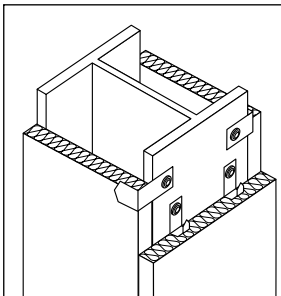

Metal clips

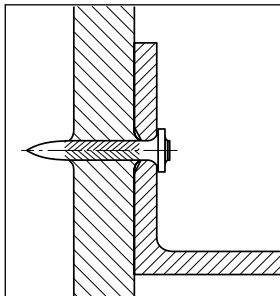

Angle bracket

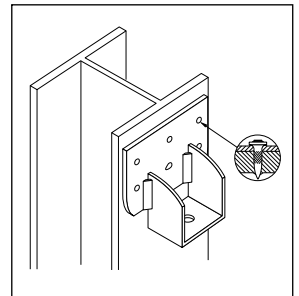

Mounting bracket

Load data

Recommended loads (predominantly static)

Steel sheet fastening

t_f [mm]	EDS_P10	
	N_{rec} [kN]	V_{rec} [kN]
0.75	1.1	1.5
1.00	1.3	2.3
1.25	1.7	3.2
≥ 2.00	2.4	4.0

- Recommended loads valid for steel sheet with minimum tensile strength ≥ 360 N/mm².
- For intermediate sheet thicknesses, use recommended load for next smaller thickness.
- N_{rec} and V_{rec} include an overall safety factor of 3.0 applied to the characteristic test data.
Static test: $N_{rec} = N_{test,k} / 3.0$, $V_{rec} = V_{test,k} / 3.0$

Forces of constraint

When fastening large pieces of steel, the possibility of shear loadings from forces of constraint should be considered. Avoid exceeding V_{rec} for the fastener shank!

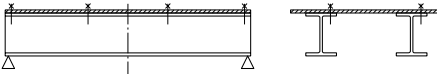

Deflection due to primary loading

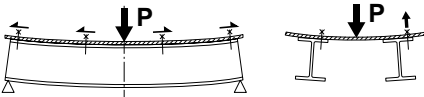

Temperature effect

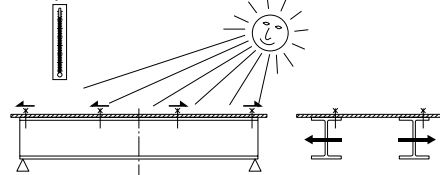

Application requirements

Thickness of base material

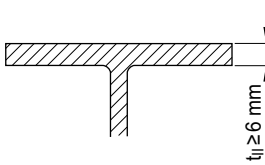

	t_{II} (mm)
EDS	≥ 6

Thickness of fastened material

$t_1 \leq 3$ mm

Steel fastened material

≤ 3 mm thick, usually deforms with the displaced base material to allow a tight fit between fastened steel and base material without pre-drilling.

Because conditions may vary, trial fastenings are recommended

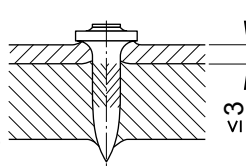

$t_1 > 3$ mm

Without pre-drilling:

steel fastened material > 3 mm thick is too stiff to deform entirely with the displaced base material. The gap, which increases with increasing t_1 , can result in bending moments being applied to the nail shank.

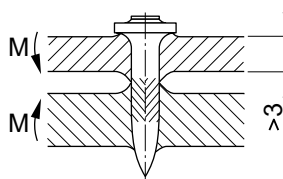

To prevent imposition of a moment on the shank of fastener, use three fasteners in a group.

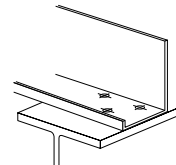

With pre-drilling:

If a gap between the fastened part and the base material is unacceptable, the fastened part can be prepared with drilled holes.

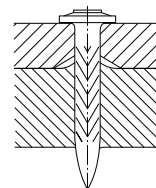
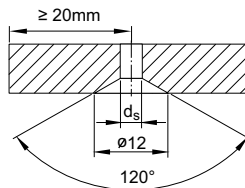

Spacing and edge distances (mm)

Base material

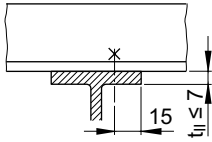

Fastened material

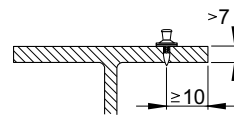
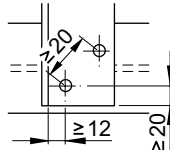

Corrosion information

The intended use only comprises fastenings which are not directly exposed to external weather conditions or moist atmospheres. For further detailed information on corrosion see relevant chapter in **Direct Fastening Principles and Technique** section.

Application limits

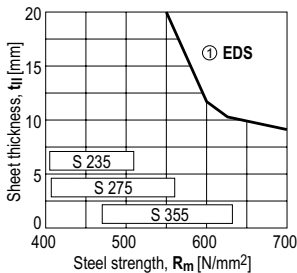

① EDS with DX76 and DX 76 PTR

- Limit line valid for steel, $t_1 \leq 3$ mm
- For steel $t_1 > 3$ mm and without pre-drilling, either make trial fastenings or adjust t_{11} to $t_{11} + t_1$ before using the chart.

Fastener program

Base material thickness	Fixed material thickness t_f [mm]									Fastener	Item no.	L_s [mm]	h_{ET} [mm]	DX tools
	≤1	2	3	5	6	7	8	9	13					
$t_{f,min} \geq 6$ mm	■	■	■	■						EDS 19 P10	46554	19	12-17	DX 76, DX76PTR
				■	■	■	■			EDS 22 P10	46556	22	12-17	
								■	■	EDS 27 P10	46557	27	12-17	

■ recommended thickness

$L_s = h_{ET} + t_f$

Cartridge recommendation

Tool energy adjustment by setting tests on site

Fastener	Cartridge selection and tool energy setting
EDS	Cartridge recommendation: 6.8/18M red or black

Fastening quality assurance

Fastening inspection

EDS __ P10

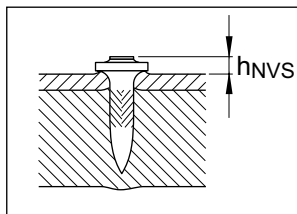

$h_{NVS} = 3.0-4.0$ mm

D

X-CR Stainless Steel Nails for Fastening to Steel

Product data

Dimensions

X-CR __ P8

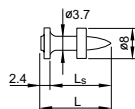

X-CR 14 D12

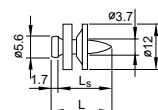

X-CR __ S12

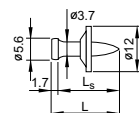

General information

Material specifications

Nail shank:	CR-500 (CrNiMo alloy) f_u ≥ 1800 N/mm²
Steel washers:	X2CrNiMo 18143
Plastic washers:	polyethylene

Recommended fastening tools

DX 460, DX 450

See **X-CR fastener program** in the next pages and **Tools and equipment** chapter for more details.

Approvals

DIBt (Germany):	X-CR 14 P8 fastening of glass facades with DX 450 (125%)
ABS, LR, IBMB:	all types



Applications (for fastenings exposed to weather or other corrosive conditions)

Examples

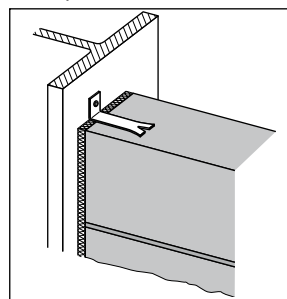

Wall ties

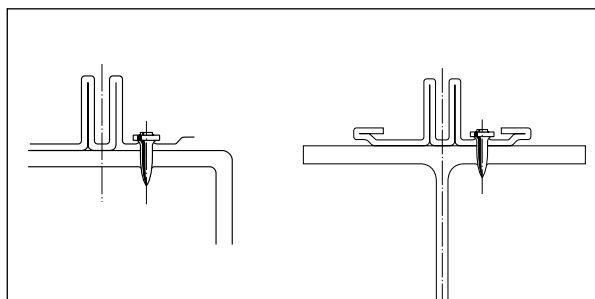

Fastening of glass facades



Load data

Recommended loads

Steel sheet fastening

Carbon steel sheet, $f_u \geq 370 \text{ N/mm}^2$

t_f [mm]	X-CR P8		X-CR D12/S12	
	N_{rec} [kN]	V_{rec} [kN]	N_{rec} [kN]	V_{rec} [kN]
0.75	1.0	1.1	1.4	1.1
1.00	1.2	1.4	1.6	1.4
1.25	1.5	1.7	1.8	1.7
2.00	2.2	2.0	2.2	2.0

Aluminium sheet, $f_u \geq 210 \text{ N/mm}^2$

t_f [mm]	X-CR P8		X-CR D12/S12	
	N_{rec} [kN]	V_{rec} [kN]	N_{rec} [kN]	V_{rec} [kN]
0.8	0.4	0.4	0.6	0.4
1.0	0.6	0.6	0.8	0.6
1.2	0.8	0.9	1.1	0.9
1.5	1.1	1.4	1.6	1.4
2.0	1.6	1.7	1.9	1.7

- Recommended working loads valid for fastened materials as shown above.
- For intermediate sheet thicknesses, use recommended load for next smaller thickness.
- For stainless steel sheet, use same loads as for carbon steel sheet.
- Recommended loads include an overall safety factor applied to the characteristic strength.
Static test: $N_{rec} = N_{test,k} / 3.0$ $V_{rec} = V_{test,k} / 3.0$
- These recommended loads are appropriate for Eurocode 1 (or similar) wind loading designs.

Other applications*

X-CR P8 / X-CR 14 D12 / X-CR S12

N_{rec} [kN]	V_{rec} [kN]	M_{rec} [Nm]
1.6	2.0	3.8

* Fastened parts: thicker steel components (clips, brackets, etc.)

- Failure of fastened material is not considered in N_{rec} and V_{rec} .
- Loads valid for predominantly static loading.

Forces of constraint

When fastening large pieces of steel or aluminium, the possibility of shear loadings from forces of constraint should be considered in the fastening design. Either allow for movement or avoid exceeding V_{rec} !

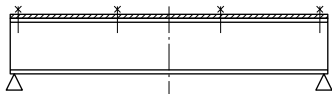

Deflection due to primary loading



Temperature effect

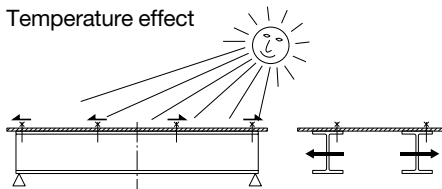
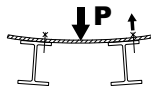
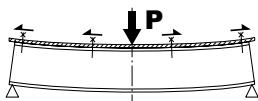

Application requirements

Thickness of base material

Using **DX 450** tool: $t_{II} \geq 5.0 \text{ mm}$ ¹⁾

¹⁾ $t_{II} \geq 4 \text{ mm}$ possible for specific types of hollow sections

Using **DX 460** tool: $t_{II} \geq 6.0 \text{ mm}$

Thickness of fastened material

$t_I \leq 12.0 \text{ mm}$ (details see fastener selection)

Spacing and edge distances (mm)

Rolled shapes

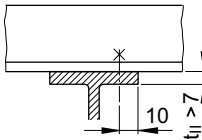

Cold formed shapes

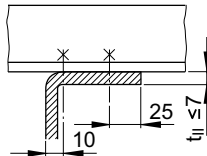

Fastened material

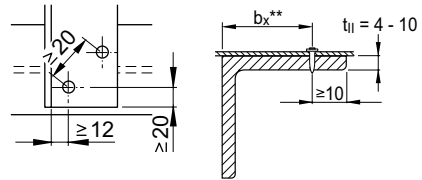

** max. allowable $b_x \leq 8 \times t_{II}$ (however, jobsite trails advisable)

Corrosion information

For fastenings exposed to weather or other corrosive conditions. Not for use in highly corrosive surroundings like swimming pools or highway tunnels.

For further detailed information on corrosion see relevant chapter in **Direct Fastening Principles and Technique** section.

Application limits

DX 450, DX 460

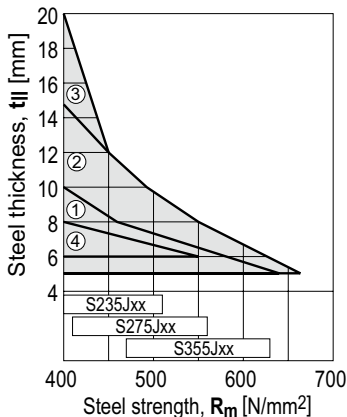

- ① **X-CR16** ($t_I \leq 3 \text{ mm}$) with DX 450 tool
- ② **X-CR14** ($t_I \leq 2 \text{ mm}$) with DX 450 tool
- ③ **X-CR14** ($t_I \leq 1 \text{ mm}$) with DX 450 tool
- ④ **X-CR14** ($t_I \leq 1 \text{ mm}$) with DX 460 tool

DX 450: Steel thickness $t_{II} \geq 5 \text{ mm}$

DX 460: Steel thickness $t_{II} \geq 6 \text{ mm}$

Fastener program

Fastening of steel sheets

Fixed material thickness t_f [mm]

≤ 1	2	3	Fastener Designation	Item no.	L_s [mm]	h_{ET} [mm]	Tool
■	■		X-CR 14 P8	306701	14	≥ 9	DX 450, DX 460
		■	X-CR 16 P8	247356	16	≥ 9	DX 450, DX 460
■			X-CR 14 D12	244601	14	≥ 9	DX 450
	■	■	X-CR 16 S12	298855	16	≥ 9	DX 450

Fastening of wood or soft material

Fixed material thickness t_f [mm]

≤ 4	5	6	8	9	11	Fastener Designation	Item no.	L_s [mm]	h_{ET} [mm]	Tool
	■	■				X-CR 18 P8	247357	18	≥ 9	DX 450, DX 460
			■	■		X-CR 21 P8	247358	21	≥ 9	DX 450, DX 460
■	■					X-CR 18 S12	298856	18	≥ 9	DX 450
		■	■			X-CR 21 S12	298857	21	≥ 9	DX 450
				■	■	X-CR 24 S12	298858	24	≥ 9	DX 450

■ = recommended thickness

 $L_s = h_{ET} + t_f$ for X-CR __P8 $L_s = h_{ET} + t_f + 1$ for X-CR __D12/S12

Cartridge recommendation

DX 460 **6.8/11M red or black cartridge**DX 450 **6.8/11M yellow cartridge** ($t_{||} \geq 5-6$ mm)**6.8/11M red cartridge** ($t_{||} > 6$ mm)

Tool energy adjustment by setting tests on site.

Fastening quality assurance

Fastening inspection

X-CR __ P8

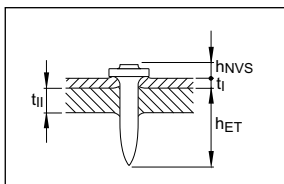
 $h_{NVS} = 3.0-4.5$ mm

X-CR 14 D12

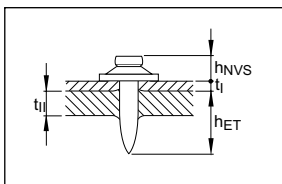
 $h_{NVS} = 4-5$ mm

X-CR __ S12

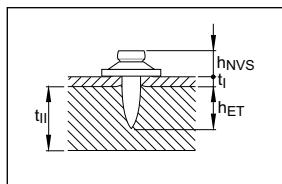
 $h_{NVS} = 4-5$ mm

X-CR Stainless Steel Nails for Concrete, Sand lime Masonry and Steel

Product data

Dimensions

X-CR __ P8

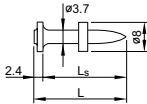

X-CR __ P8

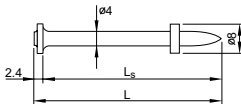

X-CR __ P8 S12

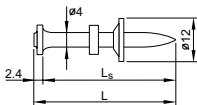

X-CR_P8 S15

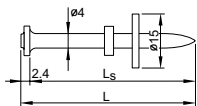

General information

Material specifications

Nail shank: CrNiMo Alloy
 $f_u \geq 1800 \text{ N/mm}^2$
 (49 HRC)

Zinc coating: X-CR 48 P8S15 has
 5–13 μm

Zinc coating to improve anchorage in concrete

Recommended fastening tools

DX 460, DX 36, DX 2, DX-E72

See **X-CR fastener program** in the next pages and **Tools and equipment** chapter for more details

Approvals

DIBt (Germany): X-CR 48 P8 S15

ICC (USA): X-CR
 with $d_{nom} = 3.7 \text{ mm}$

ABS, LR, IBMB: all types



Applications

Examples

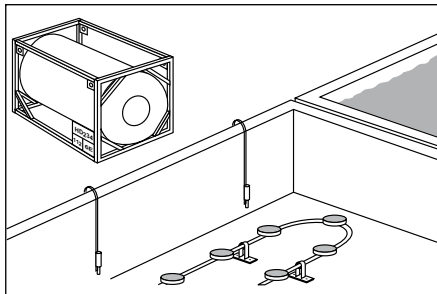

Exposure to weather or otherwise corrosive conditions

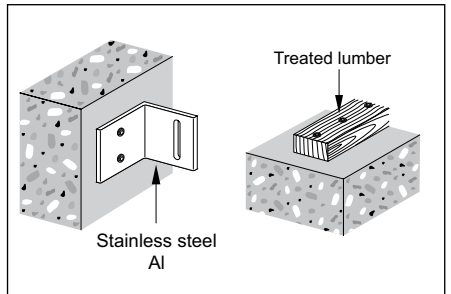

Noble or corrosive fastened material

Load data

DX Standard: Recommended loads

Fastening wood to concrete, sandlime masonry or steel

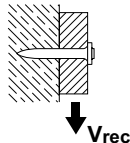
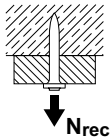

Fastening wood to concrete, sandlime masonry:

$$N_{rec} = V_{rec} = 0.4 \text{ kN}$$

Fastening wood to steel:

$$N_{rec} = V_{rec} = 0.6 \text{ kN}$$

Design conditions:

- For safety relevant fastenings sufficient redundancy of the entire system is required: minimum 5 fastenings per fastened unit with normal weight concrete base material.
- All visible failures must be replaced.
- Valid for concrete and sandlime masonry with strength of $f_{cc} < 40 \text{ N/mm}^2$.
- Valid for predominantly static loading.

Soft material:

- Working loads depend on strength and thickness of material fastened. Do not use working loads in excess of those for wood.
- Depth penetration and other conditions same as for fastening wood
- Use R23 or R36 ($\varnothing 4.5 \text{ mm}$ hole) washer to control penetration and to increase pull-over strength. Separately available from Hilti.

DX-Kwik (with pre-drilling): Recommended loads

	$N_{rec,1}$ [kN]	$N_{rec,2}$ [kN]	V_{rec} [kN]	M_{rec} [Nm]
X-CR 39/44	2.0	0.6	2.0	5.5
X-CR 48	3.0	0.9	3.0	5.5

Conditions:

- $N_{rec,1}$: concrete in compressive zone.
- $N_{rec,2}$: concrete in tension zone.
- Static or cyclic (5000 load applications) loading.
- $f_{cc} \geq 25 \text{ N/mm}^2$. For higher concrete strengths, higher loadings may be possible if supported by testing.
- A sufficient redundancy has to be ensured, that the failure of a single fastening will not lead to collapse of the entire system.
- Recommended loads are based on failure of the fastener anchorage in the concrete. Thickness and quality of the fastened material may lower the loadings.
- Observance of all pre-drilling requirements, fastened thickness limits, and recommended details.

Application requirements

Thickness of base material

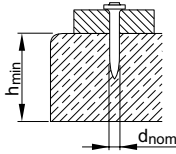

Concrete

$h_{min} = 80 \text{ mm}$ ($d_{nom} = 3.7 \text{ mm}$)

$h_{min} = 90 \text{ mm}$ ($d_{nom} \geq 4.0 \text{ mm}$)

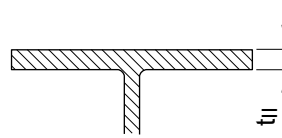

Steel

$t_{II} \geq 5 \text{ mm}$ for fastening of wood

Thickness of fastened material

$t_1 \leq 25.0 \text{ mm}$ (detailed information see fastener selection)

Spacing and edge distances (mm)

Pairs

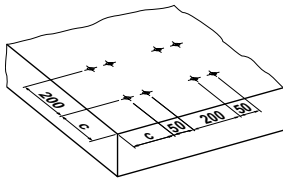

	reinforced*	non-reinforced
c	100	150

Row along edge

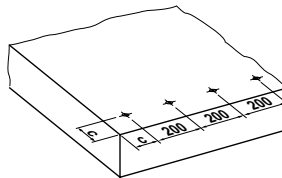

	reinforced*	non-reinforced
c	80	150

General

(e.g. group of fasteners)

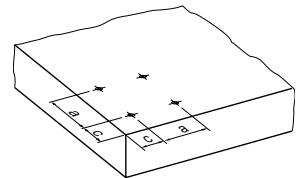

	reinforced*	non-reinforced
c	80	150
a	80	100

* Minimum $\varnothing 6 \text{ mm}$ reinforcing steel continuous along all edges and around all corners. Edge bar must be enclosed by stirrups.

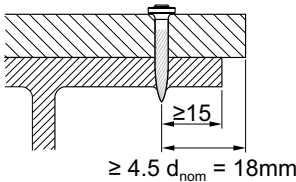

Corrosion information

For fastenings exposed to weather or other corrosive conditions. Not for use in highly corrosive surroundings like swimming pools or highway tunnels.

For further detailed information on corrosion see relevant chapter in **Direct Fastening Principles and Technique** section.

Application limits

Steel

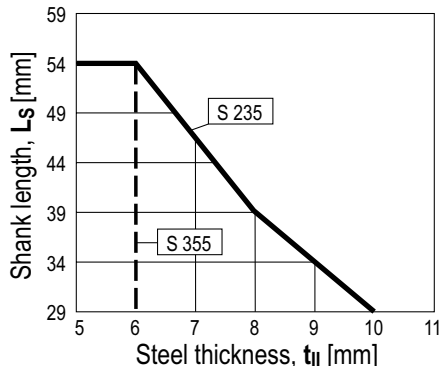

Fastener selection

DX Standard – fastening wood or soft material

Required nail shank length

Wood: $L_s = h_{ET} + t_I$ [mm]

Soft material: $L_s = h_{ET} + t_I - 2.4 - h_{CS}$ [mm]

$h_{CS} \approx 3$ mm if possible

Required depth of penetration h_{ET}

Normal weight concrete NWC

h_{ET} according to concrete strength f_{cc}

f_{cc} [N/mm ²]	15	25	35
h_{ET} [mm]	32	27	22

Light weight concrete LWC:

$h_{ET} = 32-37$ mm

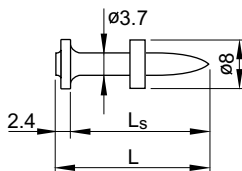

Sandlime masonry SLM

h_{ET} according to concrete strength f_{cc}

f_{cc} [N/mm ²]	15	25	35
h_{ET} [mm]	32	27	27

Steel

$h_{ET} \geq 10$ mm

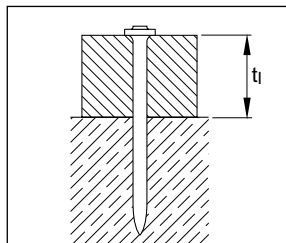

Normal weight concrete NWC

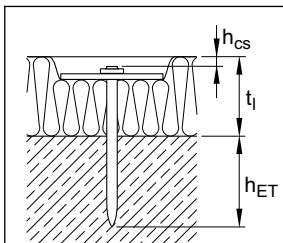

Sandlime masonry SLM

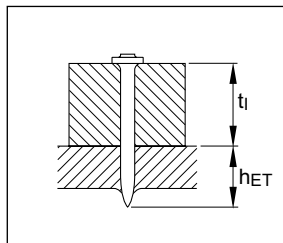

Steel

Fastener program

Fasteners				Tool
Designation	Item no	L _s [mm]	d _{nom} [mm]	Designation
X-CR 24 P8	247359	24	3.7	DX 460, DX 36, DX 2, DX-E 72 ¹⁾
X-CR 29 P8	247360	29	3.7	DX 460, DX 36, DX 2, DX-E 72 ¹⁾
X-CR 34 P8	247361	34	3.7	DX 460, DX 36, DX 2, DX-E 72 ¹⁾
X-CR 39 P8	247362	39	4.0	DX 460, DX 36, DX 2, DX-E 72 ¹⁾
X-CR 44 P8	247363	44	4.0	DX 460, DX 36, DX 2, DX-E 72 ¹⁾
X-CR 54 P8	247429	54	4.0	DX 460, DX 36, DX 2, DX-E 72 ¹⁾
X-CR 39 P8 S12	247354	39	4.0	DX 460, DX 36, DX 2 ²⁾
X-CR 44 P8 S12	247355	44	4.0	DX 460, DX 36, DX 2 ²⁾
X-CR 48 P8 S15	258121	48	4.0	DX 460, DX 36, DX 2 ²⁾
X-CR 52 P8 S15	2052687	52	4.0	DX 460

Method: ¹⁾ **DX Standard** (without pre-drilling)

²⁾ **DX-Kwik** (with pre-drilling)

Cartridge selection

DX Standard

Steel: **6.8/11M yellow, red or black cartridge**

Concrete: **6.8/11M yellow or red cartridge**

Masonry: **6.8/11M green cartridge**

DX-Kwik

Concrete: **6.8/11M yellow or red or black cartridge**

Tool energy adjustment by setting tests on site.

Fastening quality assurance

Installation instruction

DX-Kwik

Pre-drilling details (not through fastened material)

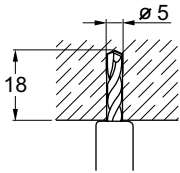

X-CR 39 / X-CR 44

Fastener	t_f [mm]	Drill bit	Item no
X-CR 39	≤ 2	TX-C-5/18	00061793
X-CR 44	2-7	TX-C-5/18	

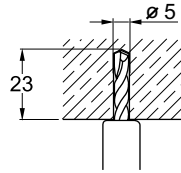

X-CR 48

Fastener	t_f [mm]	Drill bit	Item no
X-CR 48	≤ 5	TX-C-5/23	00061787

Details valid for C20/25 – C45/55 ($f_{cc} = 25\text{--}55 \text{ N/mm}^2$ / $f_c = 20\text{--}45 \text{ N/mm}^2$)

Pre-drilling details (through fastened material)

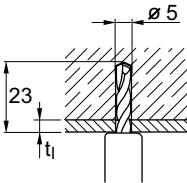

X-CR 48

Fastener	t_f [mm]	Drill bit	Item no
X-CR 48	≤ 2	TX-C-5/23	00061787

Details valid for C20/25 – C50/60

These are abbreviated instructions which may vary by application.
ALWAYS review/follow the instructions accompanying the product.

X-CT Nails for Forming or other Temporary uses

Product data

Dimensions

X-CT __ MX, X-CT __ DP8

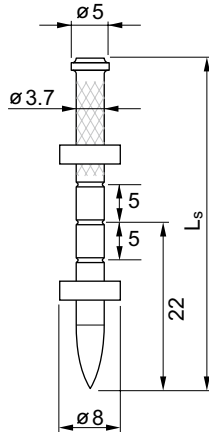

General information

Material specifications

Carbon steel shank: HRC 53

Zinc coating: 5–20 μm

Recommended fastening tools

DX 460-F8, DX 460 MX, DX 36, DX 2

See **X-CT fastener program** in the next pages and **Tools and equipment** chapter for more details.

E

Applications

Examples

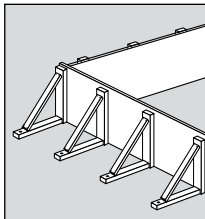

Conventional Formwork

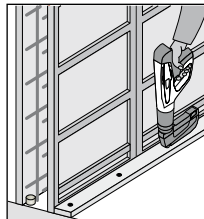

System Formwork

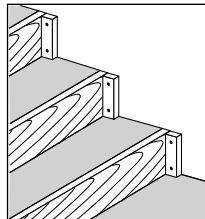

To position and hold concrete formwork

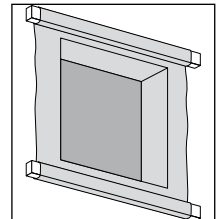

Fasten plastic, netting, etc.

Load data

Recommended loads

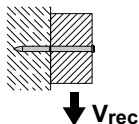

$V_{rec} = 0.3 \text{ kN}$ for $h_{ET} \geq 22 \text{ mm}$

Conditions:

- Static loading only (placing and vibration of concrete does not affect design).
- Minimum 5 fastenings per fastened unit.

Application requirements

Thickness of base and fastened material

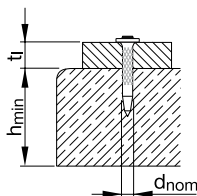

$h_{min} = 80 \text{ mm}$

$t_f = 20\text{--}50 \text{ mm}$

Edge distances

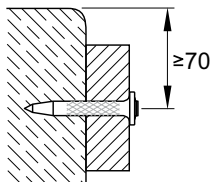

Edge distances $c \geq 70 \text{ mm}$

Fastener selection and system recommendation

Fastener selection

Required nail shank length:

$$L_S = h_{ET} + t_f \text{ [mm]}$$

Recommendation:

Concrete

$h_{ET} = 22 \text{ mm}$

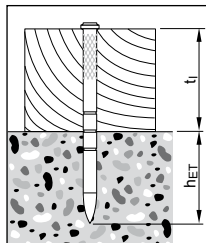

Fastener program

Fasteners

Designation	Item no. Packs of 1000 nails	100 nails	L _s [mm]	d _{nom} [mm]	Tools				Key applications
					DX 460 MX	DX 460 F8	DX 36, DX 2	DX E72	
X-CT 47 MX	383588		47	3.7	■				Wood to concrete
X-CT 52 MX	383589	383576	52	3.7	■				Wood to concrete
X-CT 62 MX	383591	383579	62	3.7	■				Wood to concrete
X-CT 72 MX		383580	72	3.7	■				Wood to concrete
X-CT 47 DP8		383582	47	3.7		■	■	■	Wood to concrete
X-CT 52 DP8		383583	52	3.7		■	■	■	Wood to concrete
X-CT 62 DP8		383585	62	3.7		■	■	■	Wood to concrete
X-CT 72 DP8		383586	72	3.7		■	■	■	Wood to concrete
X-CT 97 DP8		383587	97	3.7		■	■	■	Wood to concrete

MX: collated nails for magazine

■ recommended

Cartridge recommendation:

Green concrete: **6.8/11M green**

Normal concrete: **6.8/11M yellow**

DX-Kwik X-M6H, X-M8H Threaded Studs and DNH, X-DKH Nails

Product data

Dimensions

X-M6H-__-37 FP8

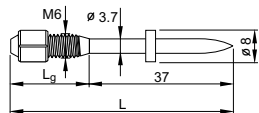

X-M8H__-37 P8

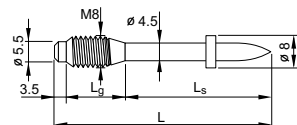

DNH 37 P8S15

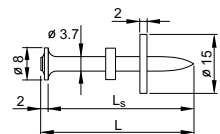

X-DKH 48 P8S15

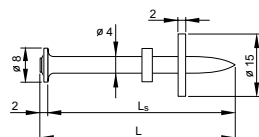

General information

Material specifications

Carbon steel shank: HRC 58
Zinc coating: 5–20 µm

Recommended fastening tools

DX 460, DX 36

See **DX-Kwik fastener program** in the next pages and **Tools and equipment** chapter for more details.

Approvals

IBMB 3041/8171 X-M8H, X-DKH, X-M6H
SOCOTEC (France): DNH, X-M8H

Note:
Technical data presented in these approvals and design guidelines reflect specific local conditions and may differ from those published in this handbook.

Applications

Examples

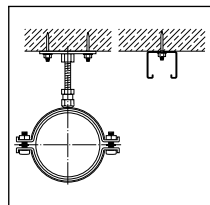

Base plates,
rails for piping

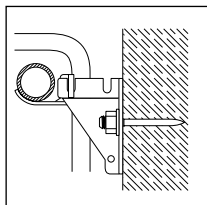

Radiator brackets

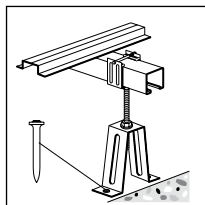

Floor stands, metal
fixtures to concrete

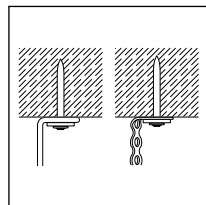

Suspended ceilings



Load data

Recommended loads

	$N_{rec,1}$ [kN]	$N_{rec,2}$ [kN]	$V_{rec,1}$ [kN]	$M_{rec,1}$ [Nm]
X-M6H, DNH 37	2.0	0.6	2.0	5.5
X-M8H, X-DKH 48	3.0	0.9	3.0	10.0

Conditions

- $N_{rec,1}$: concrete in compressive zone.
 - $N_{rec,2}$: concrete in tension zone.
 - Predominantly static loading.
 - Concrete C20/25–C50/60.
 - A sufficient redundancy has to be ensured, that the failure of a single fastening will not lead to collapse of the entire system.
 - Recommended loads are based on failure of the fastener anchorage in the concrete. Thickness and quality of the fastened material may lower the loadings.
 - Observance of all pre-drilling requirements, fastened thickness limits, and recommended details.
 - The recommended loads in the table refer to the resistance of the individual fastening and may not be the same as the loads F_N and F_V acting on the fastened part.
- Note: If relevant, prying forces need to be considered in design, see example. Moment acting on fastener shank only in case of a gap between base and fastened material.

Arrangements to prevent moment on shank:

Coupler tight against concrete

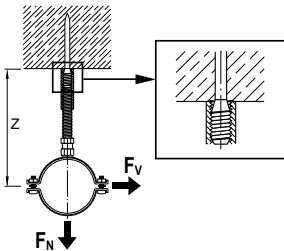

Non-symmetric arrangement

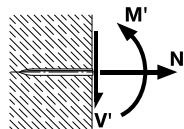
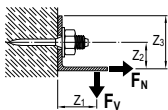

- Moment on fastened part
- Prying effect must be considered in determining loads acting on fastener

Resultant forces on nail

Application requirements

Thickness of base material

X-M6H, DNH 37: $h_{min} = 100 \text{ mm}$

X-M8H, X-DKH 48: $h_{min} = 100 \text{ mm}$

Thickness of fastened material

X-M6H: $t_1 \leq L_g - t_{washer} - t_{nut} \cong \text{up to } 13.5 \text{ mm}$

X-M8H: $t_1 \leq L_g - t_{washer} - t_{nut} \cong \text{up to } 14.0 \text{ mm}$

DNH 37: $t_1 \leq 2.0 \text{ mm}$

X-DKH 48: $t_1 \leq 5.0 \text{ mm}$ or $t_1 \leq 2.0$ by pre-drilling through fastened material

Spacing and edge distances (mm)

Pairs

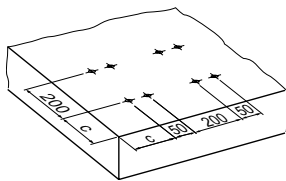

	Reinforced	Non-reinforced
c	100	150

Row along edge

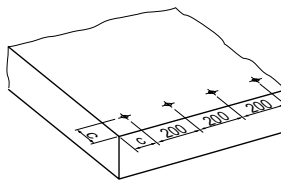

	Reinforced	Non-reinforced
c	80	150

General (e.g. group of fasteners)

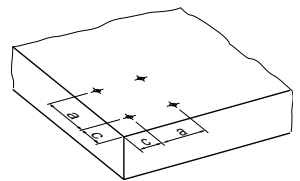

	Reinforced	Non-reinforced
c	80	150
a	80	100

Corrosion information

The intended use only comprises fastenings which are not directly exposed to external weather conditions or moist atmospheres. For further detailed information on corrosion see relevant chapter in **Direct Fastening Principles and Technique** section.

Fastener program

Fastened thickness $t_{i,max}$ [mm]	Fastener				
	Designation	Item no.	L_g [mm]	L_s [mm]	L [mm]
–	X-M6H-10-37 FP8	40464	10	37	47
–	X-M8H-10-37 P8	20059	10	37	50.5
5.0	X-M8H/5-15-37 P8	26325	15	37	55.5
15.0	X-M8H/15-25-37 P8	20064	25	37	65.5
2.0	DNH 37 P8S15	44165	–	37	39
5.0*	X-DKH 48 P8S15	40514	–	48	50

*) with pre-drilling through fastened material $t_{i,max} = 2.0$ mm

Tools, cartridge selection and tool energy setting

Designation

DX 460, DX 36: 6.8/11M yellow or red cartridge

Tool energy adjustment by setting tests on site.

Fastening quality assurance

Fastening inspection

X-M6H, X-M8H

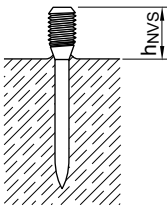

$$h_{NVS} = L - h_{ET}, \quad h_{ET} = 37-41 \text{ mm}$$

DNH 37, X-DKH 48

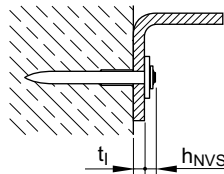

$$h_{NVS} \approx 4 \text{ mm}$$

Place nails so that heads and washers bear tightly against each other and against the fastened material

Installation

X-M6H, X-M8H

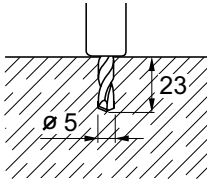

Pre-drill with drill bit
Designation Item no

TX-C-5/23B 28557

or

TX-C-5/23

61787

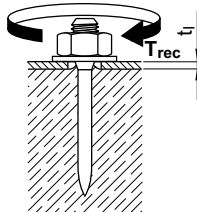

Tightening torque

Designation T_{rec} [Nm]

X-M6H 6.5

X-M8H 10.0

DNH 37, X-DKH 48

Pre-drilling details (not through fastened material)

DNH 37

t_1 [mm]	Drill-bit	Item no.
≤ 2	TX-C5/18	61793

≤ 2 **TX-C5/18** 61793

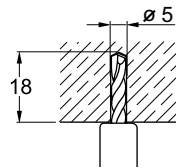

X-DKH 48

t_1 [mm]	Drill-bit	Item no.
≤ 5	TX-C-5/23B	28557

≤ 5 **TX-C-5/23B** 28557

or

TX-C-5/23 00061787

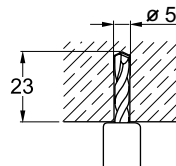

Details valid for C20/25–C50/60

Pre-drilling details (through fastened material)

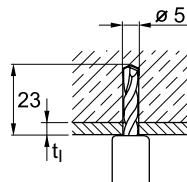

X-DKH 48

t_1 [mm]	Drill-bit	Item no.
≤ 2	only TX-C5/23	61787

≤ 2 only **TX-C5/23** 61787

Details valid for C20/25–C50/60

These are abbreviated instructions which may vary by application.

ALWAYS review/follow the instructions accompanying the product.

X-M6, X-W6, X-M8, M10, W10 Threaded Studs for Concrete

Product data

Dimensions

X-M6/W6 ____ P8

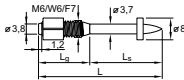

X-M8 ____ P8

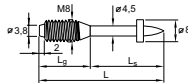

M10-24-32 P10

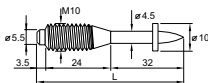

W10 ____ P10

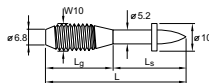

General information

Material specifications

Carbon steel shank: HRC 53.5

Zinc coating: 5–20 μm

Recommended fastening tools

DX 460, DX 351, DX 36, DX 2, DX E72, DX 76,
DX 76 PTR, DX 600 N

See **X-M6, X-W6, X-M8, M10, W10 fastener program** in the next pages and **Tools and equipment chapter** for more details.

Approvals

ICC (USA): **X-W6, W10**

UL, FM: **W10**

Note:

Technical data presented in these approvals and design guidelines reflect specific local conditions and may differ from those published in this handbook.

Applications

Examples

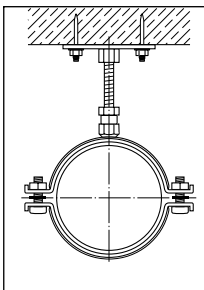

Plates for pipe rings

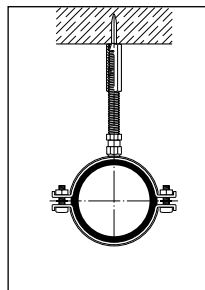

Hangings with threaded couplers

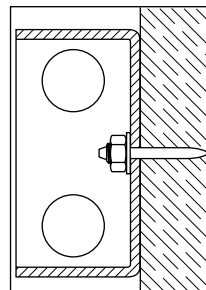

Electrical boxes

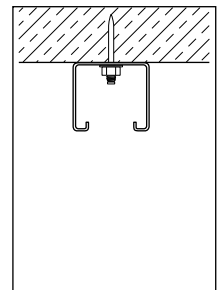

Miscellaneous attachments

Load data

Recommended loads

Fastener designation	Shank diameter d_s [mm]	M_{rec} [Nm]
X-M6/W6	3.7	5.0
X-M8, M10	4.5	9.0
W10	5.2	14.0

X-M6/W6, X-M8, M10, W10

$N_{rec} = V_{rec} =$ 0.4 kN for $h_{ET} \geq 27$ mm

$N_{rec} = V_{rec} =$ 0.3 kN for $h_{ET} \geq 22$ mm

$N_{rec} = V_{rec} =$ 0.2 kN for $h_{ET} \geq 18$ mm

Arrangements to prevent moment on shank:
Coupler tight against concrete

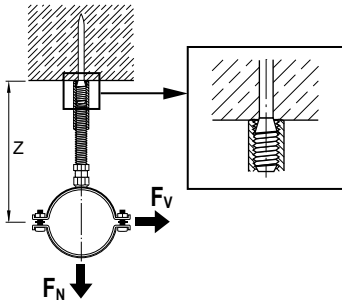

Non-symmetric arrangement:

- Moment on fastened part
- Prying effect must be considered in determining loads acting on fastener

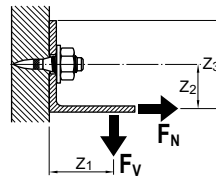

Conditions

- Minimum 5 fastenings per fastened unit (normal weight concrete)
- All visible failures must be replaced.
- With lightweight concrete base material and greater loading may be possible, please contact Hilti.
- Predominantly static loading.
- Observance of all application limitations and recommendations.
- The recommended loads in the table refer to the resistance of the individual fastening and may not be the same as the loads F_N and F_V acting on the fastened part.

Note: If relevant, prying forces need to be considered in design, see example. Moment acting on fastener shank only in case of a gap between base and fastened material.

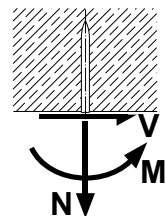

Application requirements

Thickness of base material

Concrete

$h_{\min} = 80 \text{ mm}$ ($d_{\text{nom}} = 3.7 \text{ mm}$)

$h_{\min} = 100 \text{ mm}$ ($d_{\text{nom}} \geq 4.5 \text{ mm}$)

Thickness of fastened material

M6: $t_f \leq L_g - t_{\text{washer}} - t_{\text{nut}} \cong \text{up to } 15 \text{ mm}$

W6: $t_f \leq L_g - t_{\text{washer}} - t_{\text{nut}} \cong \text{up to } 33 \text{ mm}$

M8: $t_f \leq L_g - t_{\text{washer}} - t_{\text{nut}} \cong \text{up to } 15 \text{ mm}$

M10: $t_f \leq L_g - t_{\text{washer}} - t_{\text{nut}} \cong \text{up to } 19 \text{ mm}$

W10: $t_f \leq L_g - t_{\text{washer}} - t_{\text{nut}} \cong \text{up to } 25 \text{ mm}$

Spacing and edge distances (mm)

Pairs

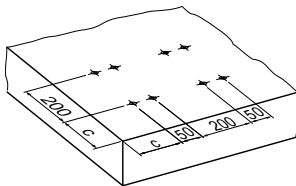

Reinforced * Non-reinforced

c 100 150

Row along edge

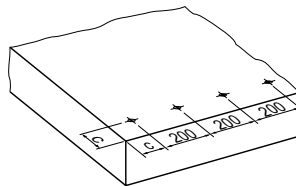

Reinforced * Non-reinforced

c 80 150

General (e.g. group of fasteners)

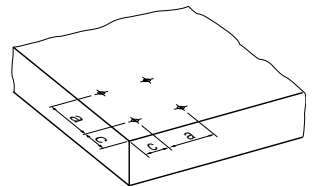

Reinforced * Non-reinforced

c 80 150

a 80 100

* Minimum $\varnothing 6$ reinforcing steel continuous along all edges and around all corners. Edge bars must be enclosed by stirrups.

Corrosion information

The intended use only comprises fastenings which are not directly exposed to external weather conditions or moist atmospheres. For further detailed information on corrosion see relevant chapter in **Direct Fastening Principles and Technique** section.

Fastener selection and system recommendation

Fastener selection

Required thread length

$L_g \geq t_f + t_{\text{washer}} + t_{\text{nut}}$ [mm]

Fastener program

Fasteners

Group ¹⁾	Designation	Item no.	Standard		Tool Designation
			threading ²⁾ L _g [mm]	shank lengths ²⁾ L _s [mm]	
M6	X-M6-20-27FP8	306079	20	27	DX 460, DX 351, DX 36, DX 2, DX E72
W6	X-W6-20-22FP8	306073	20	22	DX 460, DX 351, DX 36, DX 2, DX E72
	X-W6-20-27FP8	306074	20	27	DX 460, DX 351, DX 36, DX 2, DX E72
	X-W6-38-27FP8	306075	38	27	DX 460, DX 36, DX 2, DX E72
M8	X-M8-15-27P8	306092	15	27	DX 460, DX 36, DX 2, DX E72
	X-M8-15-42P8	306094	15	42	DX 460, DX 36, DX 2, DX E72
	X-M8-20-32P8	306096	20	32	DX 460, DX 36, DX 2, DX E72
M10	M10-24-32P10	26413	24	32	DX 76, DX 76 PTR
W10	W10-30-27P10	26472	30	27	DX 600 N
	W10-30-32P10	26473	30	32	DX 600 N
	W10-30-42P10	26476	30	42	DX 600 N

¹⁾ Type threading: M = metric; W6, W10 = Whitworth 1/4"; 3/8"

²⁾ Standard threading and shank lengths. Other lengths and combinations available on special order.

Cartridge selection

Cartridge recommendation:

M6, W6, M8: **6.8/11M yellow or red cartridge**

M10: **6.8/18M blue or red**

W10: **6.8/18 yellow, red or black**

Tool energy adjustment by setting tests on site.

Fastening quality assurance

Fastening inspection

X-M6 / W6

Penetration depth

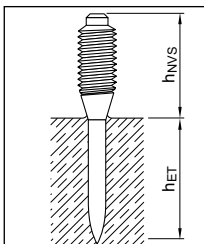

$$h_{NVS} = L_g \pm 2$$

Tightening torque

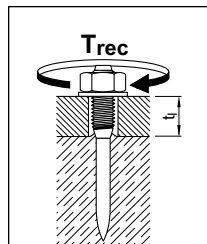

$$T_{rec} \leq 4 \text{ Nm}$$

X-M8, M10, W10

Penetration depth

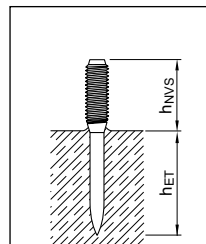

$$h_{NVS} = L_g \pm 2$$

Tightening torque

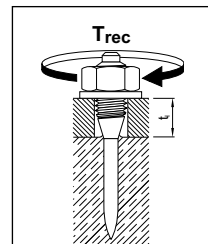

$$T_{rec} \leq 6 \text{ Nm}$$

X-EM6H, X-EW6H, X-EF7H, X-EM8H, X-EM10H, X-EW10H Threaded Studs for Steel

Product data

Dimensions

X-EM6H/EW6H-__-9 FP8

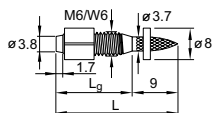

X-EF7H-7-9 FP8

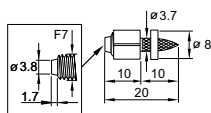

X-EM8H-__-12 P8

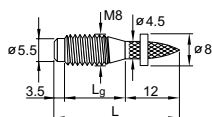

X-EM8H-15-12 FP10

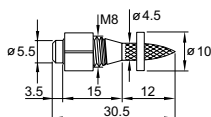

X-EM10H-24-12 P10

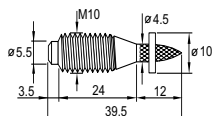

X-EW10H-30-14 P10

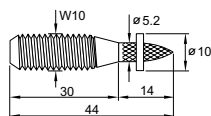

For dimension details see chapter fastener selection

General information

Material specifications

Carbon steel shank: HRC 56.5

Zinc coating: ¹⁾ 5–13 µm

¹⁾ Zinc coating (electroplating for corrosion protection during construction and service in protected environment)

Recommended fastening tools

DX 460, DX 76, DX 76 PTR, DX 600 N

See **X-EM/ X-EW fastener program** in the next pages and **Tools and equipment chapter** for more details.

Approvals

ICC-ES ESR-2347 **X-EW6H, X-EW10H, (USA):**

FM 3026695: **X-EW6H, X-EW10H**

UL: EX2258: **X-EW6H, X-EW10H**

ABS, LR: all types



Applications

Examples

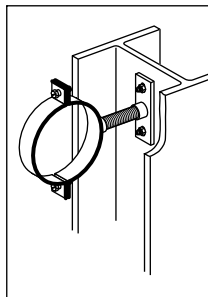

Base plates for pipe rings

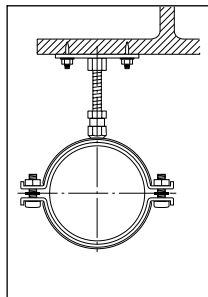

Hanging with threaded couplers

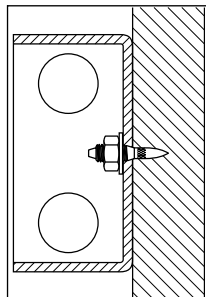

Electrical boxes

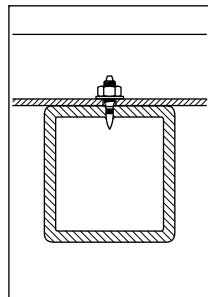

Miscellaneous attachments



Load data

Recommended loads

Fastener designation	Shank $d_s \times L_s$ [mm]	N_{rec} [kN]	V_{rec} [kN]	M_{rec} [Nm]
X-EM6H, X-EW6H, X-EF7H	3.7 x 8.5	1.6	1.6	5.0
X-EM8H, X-EM10H	4.5 x 12.0	2.4	2.4	9.0
X-EW10H-30-14	5.2 x 15.0	3.0	3.0	14.0

Conditions

- Redundancy (multiple fastening) must be provided.
- Global factor of safety for static pull-out >3 (based on 5% fractile value).
- Predominantly static loading.
- Strength of fastened material must be considered.
- Observance of all application limitations and recommendations.
- The recommended loads in the table refer to the resistance of the individual fastening and may not be the same as the loads F_N and F_V acting on the fastened part.

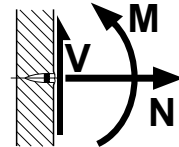

Note: If relevant, prying forces need to be considered in design, see example. Moment acting on fastener shank only in case of a gap between base and fastened material.

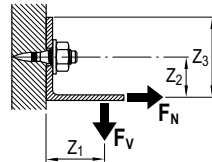

Arrangement to prevent moment on shank:
Coupler tight against steel

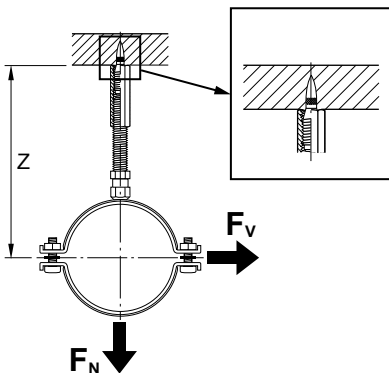

Application requirements

Thickness of base material

Minimum steel thickness:

	t_{II}
X-EM6H/EW6H, X-EF7H	$\geq 4 \text{ mm}$
X-EM8H/EW8H, X-EM10H/EW10H	$\geq 6 \text{ mm}$

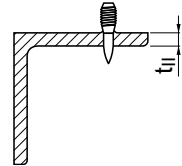

Thickness of fastened material

$$t_I \leq L_g - t_{\text{washer}} - t_{\text{nut}} \approx 1.5\text{--}33.0 \text{ mm}$$

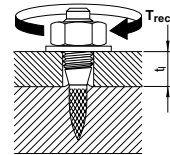

Spacing and edge distances

Edge distance and spacing: $c = s \geq 15 \text{ mm}$

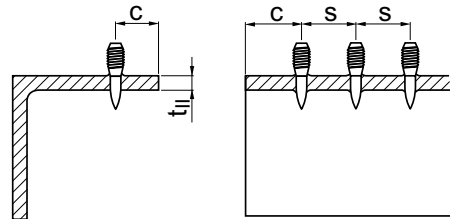

Corrosion information

The intended use only comprises fastenings which are not directly exposed to external weather conditions or moist atmospheres. For further detailed information on corrosion see relevant chapter in **Direct Fastening Principles and Technique** section.

Application limits

X-EM6H, X-EW6H, X-EF7H

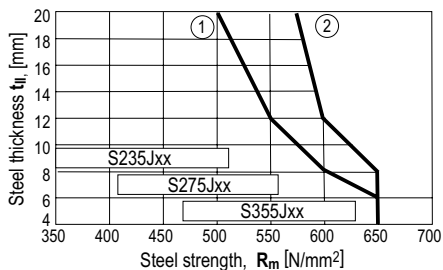

DX 460 tool:

- ① X-EF7H-__-9
- ② X-EM6H-__9,
X-EW6H-__-9

X-EM8H

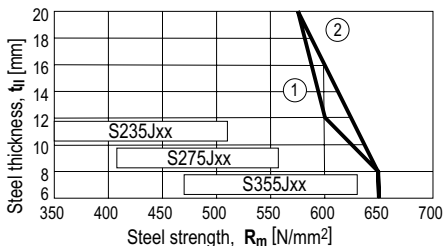

DX 460 tool:

- ① X-EM8H-__-12

**DX 76 / DX 76 PTR tool
with X-76-F10-PTR fastener guide:**

- ② X-EM8H-15-12

X-EM10H / EW10H

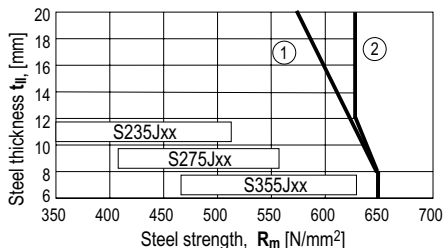

DX 76 / DX 76 PTR tool:

- ① X-EM10H-24-12

DX 600 N tool:

- ② X-EW10H-30-14 P10

Fastener selection and system recommendation

Fastener program

Base material thickness $t_{l,min}$ [mm]	Fastened thickness $t_{l,max}$ [mm]	Fastener Designation ¹⁾	Item no.	Threading length L_g [mm]	Shank lengths L_s [mm]	DX tools
4.0	1.5	X-EM6H-8-9 FP8	271965	8	8.5	DX 460
	4.5	X-EM6H-11-9 FP8	271963	11	8.5	DX 460
	13.5	X-EM6H-20-9 FP8	271961	20	8.5	DX 460
	4.5	X-EW6H-11-9 FP8	271973	11	8.5	DX 460
	13.5	X-EW6H-20-9 FP8	271971	20	8.5	DX 460
	21.5	X-EW6H-28-9 FP8	271969	28	8.5	DX 460
	31.5	X-EW6H-38-9 FP8	271967	38	8.5	DX 460
	0.5	X-EF7H-7-9 FS8	271975	7	10	DX 460
6.0	2.0	X-EM8H-11-12 P8	271983	11	12	DX 460
	6.0	X-EM8H-15-12 P8	271981	15	12	DX 460
	6.0	X-EM8H-15-12 FP10	271982	15	12	DX 76 PTR, DX 460
	14.0	X-EM10H-24-12 P10	271984	24	12	DX 76 PTR, DX 460
	20.0	X-EW10H-30-14 P10	271985	30	14	DX 600 N

¹⁾ Type of threading: **M** = metric; **W6, W10** = Whitworth $1/4''$; $3/8''$; **F7** = French 7 mm

Cartridge recommendation

Tool energy adjustment by installation tests on site

Fastener	Tool	Base material	Base material thickness (mm)	Cartridge selection
X-EM6H, X-EW6H	DX 460	S235	4–10	6.8/11M green
			10–20	6.8/11M yellow
		S275	4– 6	6.8/11M green
			6–20	6.8/11M yellow
X-EF7H	DX 460	S235	4– 8	6.8/11M green
			8–20	6.8/11M yellow
		S275	4– 6	6.8/11M green
			6–20	6.8/11M yellow
X-EM8H	DX 460	S235, S275	6– 8	6.8/11M red
			8–20	6.8/11M black
		S355	6–20	6.8/11M black



Fastener	Tool	Base material	Base material thickness (mm)	Cartridge selection
X-EM8H	DX 76 PTR	S235	6– 8	6.8/18M blue
			8–20	6.8/18M red
		S275	6– 7	6.8/18M blue
			7–12 12–20	6.8/18M red 6.8/18M black
S355	6–10 10–20	6.8/18M red 6.8/18M black		
X-EM10H	DX 76 PTR	S235	6–20	6.8/18M yellow
			S275	6– 7
		S355	7– 8 8–20	6.8/18M blue 6.8/18M red
			6– 8 8–20	6.8/18M red 6.8/18M black
X-EW10H	DX 600 N	S235	6– 8	6.8/18 blue
			8–15	6.8/18 red
			15–20	6.8/18 black
		S275	6– 8	6.8/18 blue
			8–12	6.8/18 red
			12–20	6.8/18 black
S355	6– 7 7–20	6.8/18 red 6.8/18 black		

Fastening inspection

X-EM6H, X-EW6H, X-EF7H

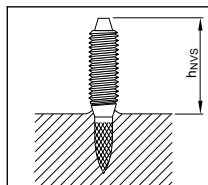

Nail standoff

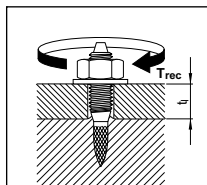

Tightening torque

X-EM8H, X-EM10H, X-EW10H

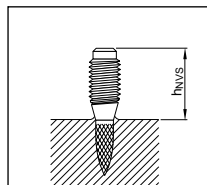

Nail standoff

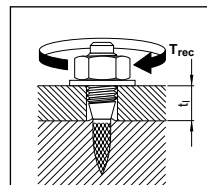

Tightening torque

Fastener	h_{NVS} [mm]	T_{rec} [Nm]
X-EM6H-8-9	8.0–11.0	≤ 4
X-EM6H- / X-EW6H-11-9	9.5–12.5	≤ 4
X-EM6H- / X-EW6H-20-9	18.5–21.5	≤ 4
X-EW6H-28-9	26.5–29.5	≤ 4
X-EW6H-38-9	36.5–39.5	≤ 4
X-EF7H-7-9	9.0–12.0	≤ 4

Fastener	h_{NVS} [mm]	T_{rec} [Nm]
X-EM8H-11-12	11.5–15.5	≤10.5
X-EM8H-15-12	15.5–19.5	≤10.5
X-EM10H-24-12	26.5–29.5	≤10.5
X-EW10H-30-14	28.0–31.0	≤15.0

X-BT stainless steel threaded studs

Product data

Dimensions

X-BT W10-24-6 SN12-R X-BT M8-15-6 SN12-R
 X-BT M10-24-6 SN12-R

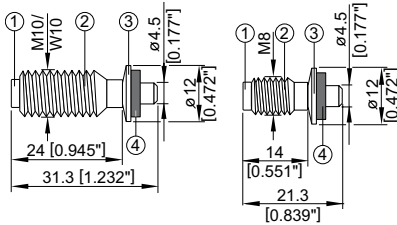

X-BT W6-24-6 SN12-R
 X-BT M6-24-6 SN12-R

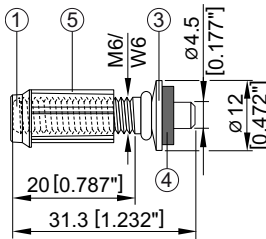

General information

Material specifications

- ① Shank:
 - CR 500 (CrNiMo alloy) equivalent to A4 / S31803 (1.4462) AISI grade 316 material
 - N 08926 (1.4529) † Available on request
- ② Threaded sleeve: X5CrNiMo 17-12-2+2H, 1.4401
- ③ SN12-R washers: S 31635 (X2CrNiMo 17-12-2, 1.4404)
- ④ Sealing washers: Elastomer, black *
- ⑤ Guide sleeve: Plastic

* Resistant to UV, salt water, water, ozone, oils, etc.
 †) For High Corrosion Resistance HCR material inquire at Hilti

Designation according to Unified Numbering System (UNS)

Recommended fastening tools

DX 351-BT / BTG

See **X-BT fastener program** in the next pages and **Tools and equipment** chapter for more details.

Approvals

ICC ESR-2347 (USA), ABS, LR, UL, DNV, BV 23498/A1, GL 12272-10HH, Russian Maritime Register



Applications

Examples

Threaded stud applications especially for:

- High strength steel
- Coated steel structures
- Through penetration of base steel is not allowed

Grating with **X-FCM-R**

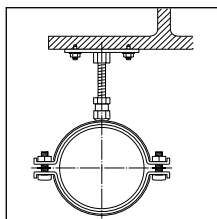

Base plates

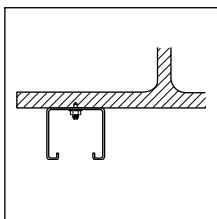

Installation rails

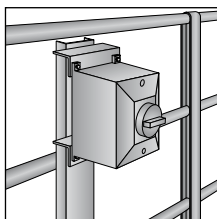

Junction box, etc.

Load data

Recommended loads – steel

Steel grade: Europe, USA	S235, A36	S355, Grade 50 and stronger steel
Tension, N_{rec} [kN/lb]	1.8 / 405	2.3 / 517
Shear, V_{rec} [kN/lb]	2.6 / 584	3.4 / 764
Moment, M_{rec} [Nm/lbft]	8.2 / 6	8.2 / 6
Torque, T_{rec} [Nm/lbft]	8 / 5.9	8 / 5.9

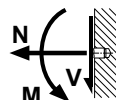

Example:

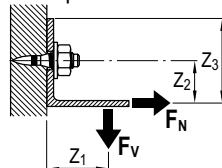

Recommended loads – cast iron *

Tension, N_{rec} [kN/lb]	0.5 / 115
Shear, V_{rec} [kN/lb]	0.75 / 170
Moment, M_{rec} [Nm/lbft]	8.2 / 6

Conditions for recommended loads:

- Global factor of safety for static pull-out > 3 (based on 5% fractile value)
- Minimum edge distance = 6 mm [$1/4"$].
- Effect of base metal vibration and stress considered.
- Redundancy (multiple fastening) must be provided.
- The recommended loads in the table refer to the resistance of the individual fastening and may not be the same as the loads F_N and F_V acting on the fastened part.

Note: If relevant, prying forces need to be considered in design, see example. Moment acting on fastener shank only in case of a gap between base and fastened material.

*Requirements of spheroidal graphite cast iron base material

Subject	Requirements
Cast iron	Spheroidal graphite cast iron according to EN 1563
Strength class	EN-GJS-400 to EN-GJS-600 according to EN 1563
Chemical analysis and amount of carbon	3.3–4.0 mass percentage
Microstructure	Form IV to VI (spherical) according to EN ISO 945-1:2010 Minimum size 7 according to Figure 4 of EN ISO 945-1:2010
Material thickness	$t_{II} \geq 20$ mm

Design resistance – steel

Steel grade:		S235	S355
Europe			
Tension	N_{Rd} [kN]	2.9	3.7
Shear	V_{Rd} [kN]	4.2	5.4
Moment	M_{Rd} [Nm]	18.4	18.4

Design resistance – cast iron *

Tension	N_{RD} [kN]	0.8
Shear	V_{RD} [kN]	1.2
Moment	M_{RD} [Nm]	13.1

Recommended interaction formula for combined loading - steel and cast iron base material

Combined loading situation	Interaction formula
----------------------------	---------------------

V-N (shear and tension) $\frac{V}{V_{rec}} + \frac{N}{N_{rec}} \leq 1.2$ with $\frac{V}{V_{rec}} \leq 1.0$ and $\frac{N}{N_{rec}} \leq 1.0$

V-M (shear and bending) $\frac{V}{V_{rec}} + \frac{M}{M_{rec}} \leq 1.2$ with $\frac{V}{V_{rec}} \leq 1.0$ and $\frac{M}{M_{rec}} \leq 1.0$

N-M (tension and bending) $\frac{N}{N_{rec}} + \frac{M}{M_{rec}} \leq 1.0$

V-N-M (shear, tension and bending) $\frac{V}{V_{rec}} + \frac{N}{N_{rec}} + \frac{M}{M_{rec}} \leq 1.0$

Cyclic loading:

- Anchorage of **X-BT-R** threaded stud in steel base material is not affected by cyclic loading.
- Fatigue strength is governed by fracture of the shank. Inquire at Hilti for test data if high cycle loading has to be considered in the design.



Application requirements

Thickness of base material

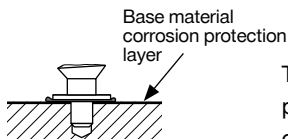
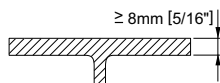

Thickness of base material corrosion protection layer $\leq 0.4\text{mm}$. For thicker coatings, please contact Hilti.

Thickness of fastened material

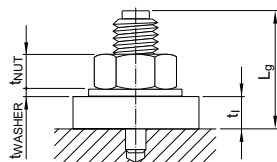

X-BT M8: $2.0 \leq t_f \leq 7.0\text{ mm}$

X-BT M10 / X-BT W10: $2.0 \leq t_f \leq 15.0\text{ mm}$

X-BT M6 / X-BT W6: $1.0 \leq t_f \leq 14.0\text{ mm}$

Note:

For X-BT with SN 12R sealing washer $t_1 \geq 2.0\text{ mm}$

For X-BT M6 / W6 with SN 12R sealing washer $t_1 \geq 1.0\text{ mm}$

Spacing and edge distances

Edge distance: $\geq 6\text{ mm}$

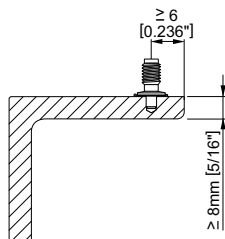

Spacing: $\geq 15\text{ mm}$

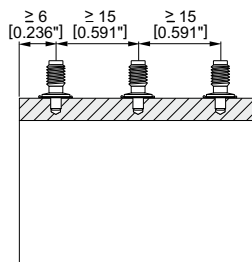

Corrosion information

The corrosion resistance of Hilti CR500 and S31803 stainless steel material is equivalent to AISI 316 (A4) steel grade.

Studs made of N 08926 (HCR) material with higher corrosion resistance, e.g. for use in road tunnels or swimming pools, are available on special order.

Application limit

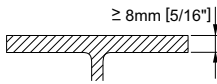

- $t_{II} \geq 8 \text{ mm } [5/16"] \rightarrow$ No through penetration
- No limits with regards to steel strength

Fastener selection and system recommendation

Fastener program

Designation	Item no.	Tool Designation
X-BT M8-15-6 SN12-R	377074	DX 351-BTG
X-BT M10-24-6 SN12-R	377078	DX 351-BT
X-BT W10-24-6 SN12-R	377076	DX 351-BT
X-BT W10 without washer	377075	DX 351-BT
X-BT M6-24-6 SN12-R	432266	DX 351-BT
X-BT W6-24-6 SN12-R	432267	DX 351-BT

Note: For High Corrosion Resistance HCR material inquire at Hilti

Cartridge selection and tool energy setting

6.8/11 M high precision brown cartridge

Fine adjustment by installation tests on site

Fastening quality assurance

Fastening inspection

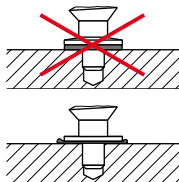
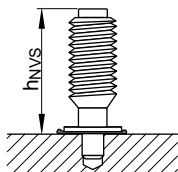
**X-BT M8** $h_{NVS} = 15.7-16.8 \text{ mm}$ **X-BT M10 / X-BT W10 and****X-BT M6 / X-BT W6** $h_{NVS} = 25.7-26.8 \text{ mm}$

Installation

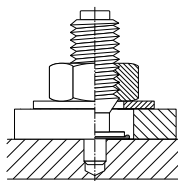
X-BT with washer

Fastened material hole \varnothing
 $\geq 13 \text{ mm}$

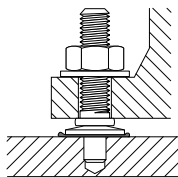
X-BT M6 / X-BT W6

Fastened material with
 pre-drilled hole diameter
 $< 7 \text{ mm}$

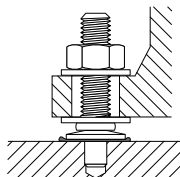

Fastened material with
 pre-drilled hole diameter
 $\geq 7 \text{ mm}$

Pre-drill with **TX-BT 4/7** step shank drill bit

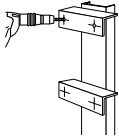

Pre-drill until the shoulder grinds a shiny ring (to ensure proper drilling depth)



Before fastener installation:
the drilled hole must be clear of liquids and debris.
The area around the drilled hole must be free from liquids and debris.

Tighten using a screwdriver with torque clutch

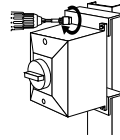

Tightening torque:
T_{rec} ≤ 8 Nm (5.9 ft-lb)!

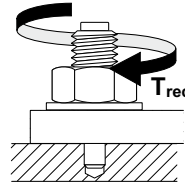

Hilti screwdriver:	Torque setting:
SF 121-A	11
SF 150-A	9
SF 180-A	8
SF 144-A	9
SF 22A	9

These are abbreviated instructions which may vary by application.
ALWAYS review/follow the instructions accompanying the product.

X-CRM Stainless Steel Threaded Studs for Concrete and Steel

Product data

Dimensions

X-CR M8-__-42 P8 (DX-Kwik)
Threaded sleeve: A4 (AISI 316)

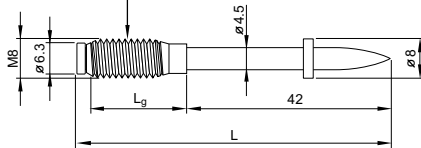

X-CR M8-__-12 FP10
Threaded sleeve: A4 (AISI 316)

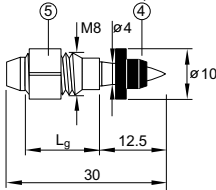

X-CR M8-__-12 P8
Threaded sleeve: A4 (AISI 316)

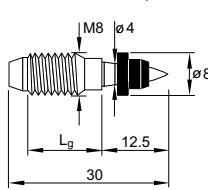

General information

Material specifications

Shank: CrNiMo alloy
 $f_u \geq 1800 \text{ N/mm}^2$
(49 HRC)

Threaded sleeve: A4 (AISI 316)

Zinc coating to facilitate anchoring in concrete

(X-CR M8-__-42): 5–13 μm

Washers/
guidance sleeve: polyethylene

Recommended fastening tools

DX 460, DX 36, DX 2, DX 76, DX 76 PTR

See **X-CR M fastener program** in the next pages and **Tools and equipment** chapter for more details.

Approvals

DIBt (Germany): **X-CR M8-__-42 P8**
(DX-Kwik)

ICC ESR-2347: **X-CR M8-9-12,**
X-CR M8-15-12

ABS, LR: all types



Note: technical data presented in these approvals and design guidelines reflect specific local conditions and may differ from those published in this handbook.

Applications

Examples

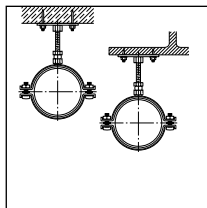

Base plates for pipe rings

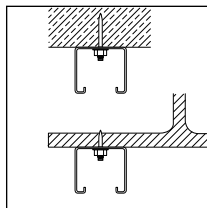

Installation rails

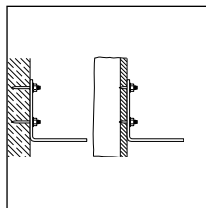

Facade brackets

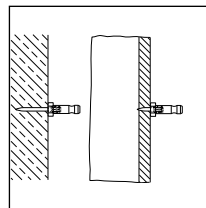

Special purpose connections

Load data

Recommended loads

Fastening to steel

	N_{rec} [kN]	V_{rec} [kN]	M_{rec} [Nm]
X-CR M8	1.8	1.8	5.5

Conditions:

- For safety-relevant fastenings sufficient redundancy of the entire system is required.

Fastening to concrete – DX-Kwik method (pre-drilling)

	$N_{rec,1}$ [kN]	$N_{rec,2}$ [kN]	V_{rec} [kN]	M_{rec} [Nm]
X-CR M8-__-42 P8	3.0	0.9	3.0	5.5

Conditions:

- $N_{rec,1}$: concrete in compressive zone
- $N_{rec,2}$: concrete in tension zone
- $f_{cc} \geq 20 \text{ N/mm}^2$
- A sufficient redundancy has to be ensured, that the failure of a single fastening will not lead to collapse of the entire system.
- Observance of all pre-drilling requirements

Arrangements to reduce or prevent moment on shank:

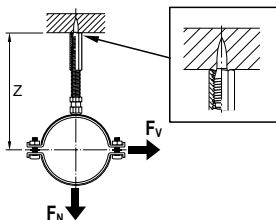

Application requirements

Thickness of base material

Concrete – DX-Kwik

$h_{min} = 100 \text{ mm}$

Steel

$t_{II} \geq 6 \text{ mm}$

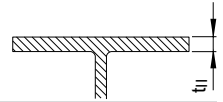

Thickness of fastened material

X-CR M8

$t_I \leq L_g - t_{washer} - t_{nut} \approx \text{up to } 13.0 \text{ mm}$

Spacing and edge distances (mm)

Fastening to steel

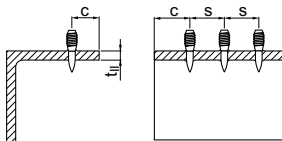

$c, s \geq 15 \text{ mm}$

Fastening to concrete

Pairs

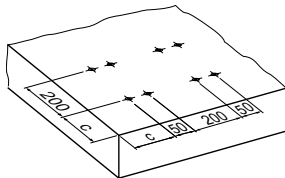

Reinforced * Non-reinforced

c 100 150

Row along edge

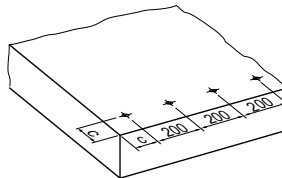

Reinforced * Non-reinforced

c 80 150

General (e.g. group of fasteners)

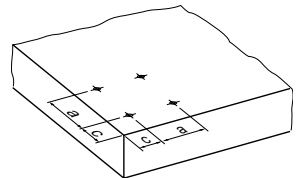

Reinforced * Non-reinforced

c 80 150

a 80 100

* Minimum $\varnothing 6$ reinforcing steel continuous along all edges and around all corners. Edge bars must be enclosed by stirrups

Corrosion information

For fastenings exposed to weather or other corrosive conditions. Not for use in highly corrosive surroundings like swimming pools or highway tunnels.

Application limits

Concrete:

No general restrictions existent. Limitations are dependent on application and user requirements.

Steel: DX 76, DX 76 PTR

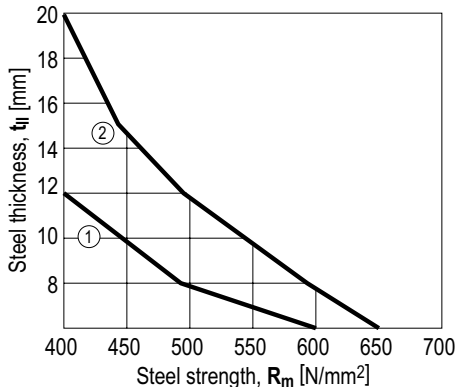

- ① **X-CRM8-15-12 FP10** / DX 76 (impact)
 ② **X-CRM8-15-12 FP10** / DX 76 (co-acting)

Steel: DX 460

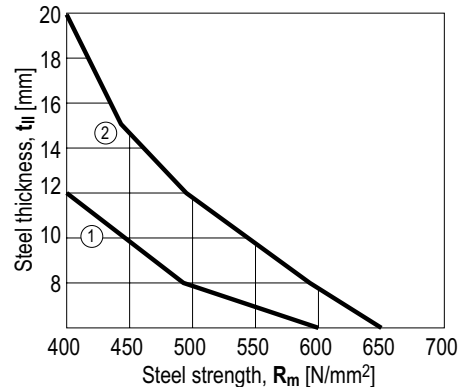

- ① **X-CRM8-15-12 P8** / DX 460 (impact)
 ② **X-CRM8-15-12 P8** / DX 460 (co-acting)

Fastener selection and system recommendation

Fastener program

Fastened thickness $t_{f,max}$ [mm]	Fastener Designation ¹⁾	Item no.	L_g [mm]	L_s [mm]	Tools
Base material concrete, DX-Kwik method					
5.0	X-CR M8-14-42 P8	255911	14	42	DX 460, DX 36, DX 2
13.0	X-CR M8-22-42 P8	255910	22	42	DX 460, DX 36, DX 2
Base material steel					
6.0	X-CR M8-9-12 P8	372031	9	12.5	DX 460
6.0	X-CR M8-15-12 P8	372033	15	12.5	DX 460
6.0	X-CR M8-9-12 FP10	372032	9	12.5	DX 460, DX 76, DX 76 PTR
6.0	X-CR M8-15-12 FP10	372 034	15	12.5	DX 460, DX 76, DX 76 PTR

¹⁾ Type threading: M = metric; W6 = Whitworth 1/4"

Cartridge selection and tool energy setting

Base material	Designation	Tool
Concrete	6.8/11M yellow or red cartridge	DX 460, DX 36, DX 2
Steel	6.8/11M red cartridge	DX 460
Steel	6.8/18M cartridge	DX 76, DX 76 PTR

Tool energy adjustment by setting tests on site.

Fastening quality assurance

Fastening inspection

Fastening to concrete

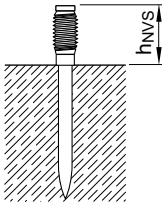

DX-Kwik (pre-drilling)

Fastener	hNVS [mm]
X-CR M8-14-42 P8	12.0 – 16.0
X-CR M8-22-42 P8	20.0 – 24.0

Fastening to steel

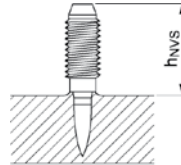

Fastener	hNVS [mm]
X-CR M8-9-12 P8	12.0 – 15.0
X-CR M8-15-12 P8	17.0 – 20.0
X-CR M8-9-12 FP10	12.0 – 15.0
X-CR M8-15-12 FP10	17.0 – 20.0

Installation

Fastening to concrete

DX-Kwik (pre-drilling)

X-CR M8- -42 P8

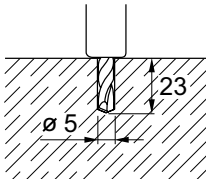

Pre-drill with drill bit
TE-C-5/23B (Item-no.
28557) or TE-C-5/23
(Item no. 00061787)

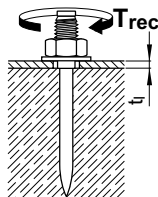

Tightening torque
 $T_{rec} = 10 \text{ Nm}$

Fastening to steel

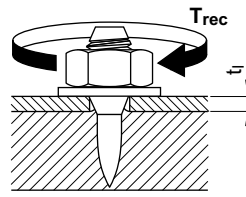

Tightening torque
X-CR M8 $T_{rec} = 8.5 \text{ Nm}$

These are abbreviated instructions which may vary by application.
ALWAYS review/follow the instructions accompanying the product.

X-FCM Grating Fastening System

Product data

Dimensions

X-FCM

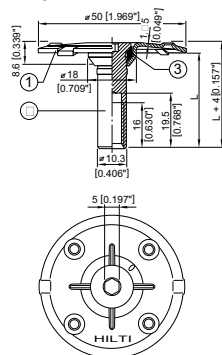

X-FCM-M_L

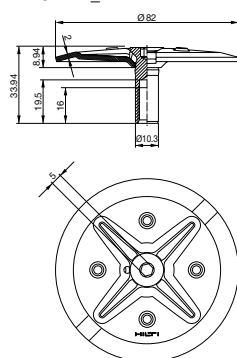

X-CRM8-15-12 FP10

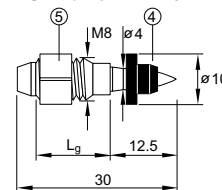

X-CRM8-15-12 P8

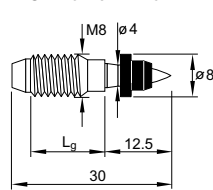

X-EM8H-15-12 FP10

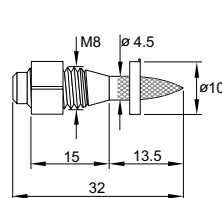

X-EM8H-15-12 P8

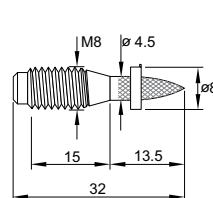

X-BT M8-15-6 SN12-R

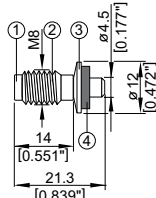

General information

Material specifications

See fastener selection for more details.

Recommended fastening tools

See **X-FCM fastener program** in the next pages and **Tools and equipment** chapter for more details.

Approvals

GL, BV, DNV: X-FCM-M, X-FCM-R
 ABS, LR: all types
 No approvals for X-FCM-M_L



Applications

Example

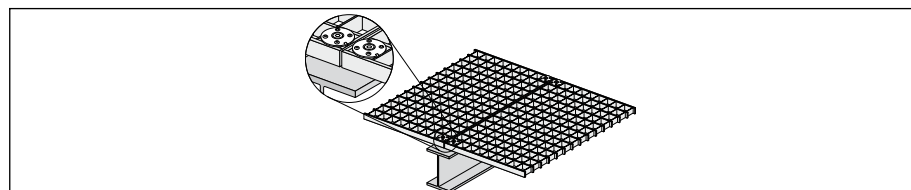

Grating (steel and fiberglass reinforced)



Load data

Recommended tensile loads N_{rec} [kN]

Grating opening type

	Rectangular		Square	
	Bar spacing [mm]		Bar spacing [mm]	
	18	30	18	30
X-FCM	0.8**	0.8**	2.4*	0.8**
X-FCM-M	0.8**	0.8**	1.8*	0.8**
X-FCM-R	1.4**	1.0**	1.8*	1.0**

Grating opening type

	Rectangular		Square	
	Bar spacing [mm]		Bar spacing [mm]	
	30	57	30	60
X-FCM-M_L	0.8**	0.8**	1.8*	0.8**

* Loading is limited by recommended load for threaded stud.

** Loading is limited by elastic limit of the **X-FCM** disk. Exceeding recommended loads can result in plastic deformation of disk.

Notes:

X-FCM, X-FCM-M, X-FCM-R, X-FCM-M_L resist shear by friction and are not suitable for explicit shear load designs, e.g. diaphragms. Depending on surface characteristics, shear loads of up to about 0.3 kN will not result in permanent deformation. Therefore small unexpected shear loads can generally be accommodated without damage.

Characteristic tensile loads N_{Rk} :

Type	Grating – bar spacing	X-FCM-R with		X-CRM
		X-BT S235 / A36 steel	> S355 / Grade 50 steel	
	Rectangle 18 mm	4.2 kN / 945 lb*	4.2 kN / 945 lb*	4.2 kN / 945 lb*
	Rectangle 30 mm	3.0 kN / 675 lb*	3.0 kN / 675 lb*	3.0 kN / 675 lb*
	Square 18 mm	5.4 kN / 1215 lb	6.9 kN / 1550 lb	5.4 kN / 1215 lb
	Square 30 mm	3.0 kN / 675 lb*	3.0 kN / 675 lb*	3.0 kN / 675 lb*

* Loading is limited by elastic limit of the **X-FCM** disc.

Load displacement behaviour – examples:

Tensile load

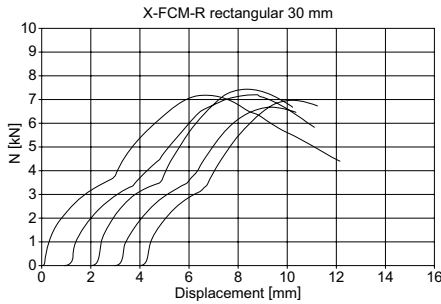

Shear load

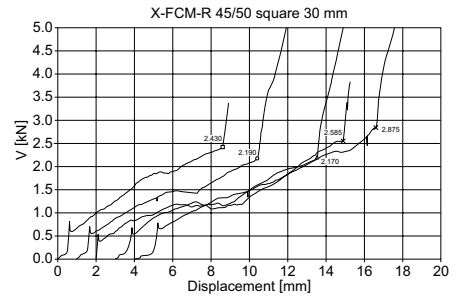

Application requirements

Thickness of base material

X-BT

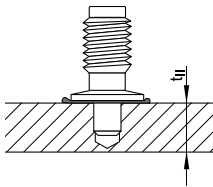

$t_{II} \geq 8 \text{ mm}$

X-CRM and X-EM8H

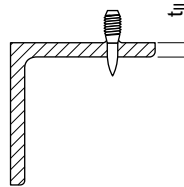

$t_{II} \geq 6 \text{ mm}$

Thickness of fastened material

Grating height: 25–50 mm with standard X-FCM. For other dimensions special X-FCM are available on demand.

Spacing and edge distances

X-CRM, X-EM8H

Edge distances: $c \geq 15 \text{ mm}$

Spacing: $s \geq 15 \text{ mm}$

X-BT

Edge distance: $c \geq 6 \text{ mm}$

Spacing: $s \geq 15 \text{ mm}$

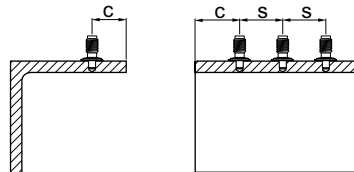

Corrosion information

The intended use of the **X-EM8H** carbon steel fasteners only comprises fastenings which are not directly exposed to external weather conditions or moist atmospheres. For outdoor applications **X-BT** or **X-CRM** stainless steel fasteners have to be used, see fastener selection.

Application limits

DX 76, DX 76 PTR

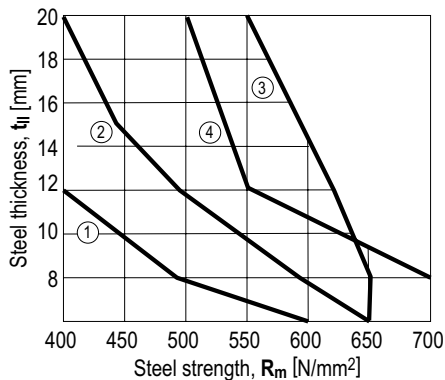

- ① **X-CRM8-15-12 FP10** /
DX 76, DX 76 PTR (impact)
- ② **X-CRM8-15-12 FP10** /
DX 76, DX 76 PTR (co-acting)
- ③ **X-EM8H-15-12 FP10** /
DX 76, DX 76 PTR (impact)
- ④ **X-EM8H-15-12 P8** /
DX 76, DX 76 PTR (impact)

DX 460

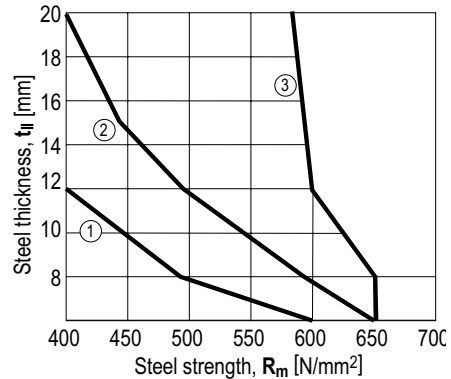

- ① **X-CRM8-15-12 P8** / DX 460 (impact)
- ② **X-CRM8-15-12 P8** / DX 460 (co-acting)
- ③ **X-EM8H-15-12 P8** / DX 460 (impact)

X-BT: No application limits → using in high strength steel
 No through penetration → $t_{II} \geq 8 \text{ mm}$ [°/16"]

Fastener selection and system recommendation

Fastener program

Application areas

Indoors, dry and non corrosive environment

Indoors, mildly corrosive environment, or for limited lifetime use

Marine, offshore, petrochemical, calorific (coal, oil) power plants, etc.

X-FCM system

X-FCM

Zinc plated

Item no.

X-FCM-M

Duplex coated

Item no.

X-FCM-R

Stainless steel

Item no.

Dimensions

L

[mm]

Grating

height

[mm]

Tools

X-FCM 25/30	26582 or 2117353	X-FCM-M 25/30	378683 or 2117357	X-FCM-R 25/30	247181 or 2117391	23	25-30	1)
X-FCM 1"-1 1/4"	247175 or 2117354	X-FCM-M 1"-1 1/4"	378686 or 2117358	X-FCM-R 1"-1 1/4"	247184 or 2117392	27	29-34	1)
X-FCM 35/40	26583 or 2117355	X-FCM-M 35/40	378684 or 2117359	X-FCM-R 35/40	247182 or 2117393	33	35-40	1)
X-FCM 45/50	26584 or 2117356	X-FCM-M 45/50	378685 or 2117390	X-FCM-R 45/50	247183 or 2117394	43	45-50	1)
		X-FCM-M 31/36 L	2042852*			25	31-36	1)

*For use only with X-BT M8-15-6 SN12-R

Note:
Not for use in marine atmosphere or in heavily polluted environment.

Note:
Not for use in automobile tunnels, swimming pools or similar environments

1) SF 100-A, SF 11-A, SF 150-A, SF 121-A, SF 14, SF 14-A, SF 18-A, SFC 18-A, SF 22-A

Threaded studs

	Item no.	Tools
X-EM8H-15-12 P8	271981	2)
X-EM8H-15-12 FP10	271982	2)
X-BT M8-15-6 SN12-R	377074	3)
X-CR M8-15-12 P8	372033	2)
X-CR M8-15-12 FP10	372034	2)

2) DX 76 PTR, DX 460

3) DX 351-BTG

Cartridge selection and tool energy setting

X-BT

6.8/11M high precision brown cartridges

X-CRM

6.8/11M yellow or red cartridges with
DX 460

6.8/18M blue cartridges with DX 76 and
DX 76 PTR

Tool energy adjustment by setting tests on site.

X-EM8H

6.8/11M red or black cartridges with
DX 460

6.8/18M blue, red or black cartridges with
DX 76 and DX 76 PTR

Material specifications and coatings

X-FCM system

	X-FCM-R		X-FCM-M+X-FCM-M_L		X-FCM		All systems (^③ Absorber ¹⁾)
	^① Disk	^② Threaded stem	^① Disk	^② Threaded stem	^① Disk	^② Threaded stem	
Material designation	X2CrNiMo17122	X2CrNiMo17122	DC 04	11SMNPB30+C	DC 04	11SMNPB30+C	Polyurethane Black
Coating	none	none	Duplex *	Duplex *	≥ 20µm Zn	10-20 µm Zn	-

¹⁾ resistant to: UV, saltwater ozone, oil, grease

^{*}) comparable to 45 µm HDG steel (480 h Salt spray test per DIN 50021)

Threaded studs

	X-BT			X-CRM8		X-EM8H
	Shank ^①	Threaded sleeve ^② SN12-R washer ^③	Sealing washer ¹⁾ ^④	Shank	Threaded sleeve	
Material designation	Stainless steel CR 500 (A4 / AISI316)	X2CrNiMo17132 X5CrNiMo17122+2H (A4 / AISI316)	Elastomer, black	Stainless steel CR 500 (A4 / AISI316)	X2CrNiMo17132 X5CrNiMo17122+2H (A4 / AISI316)	Carbon steel Ck 67 MOD
Coating	none	none		none	none	5-13 µm Zn ²⁾

¹⁾ resistant to: UV, saltwater ozone, oil, grease

²⁾ Zinc applied by electroplating. Intended for corrosion protection during shipment, storage, construction and service in protected environment. It is not adequate for protection against corrosion in outside or otherwise corrosive applications

Fastening quality assurance

Fastening inspection

X-BT M8-15-6 SN12-R

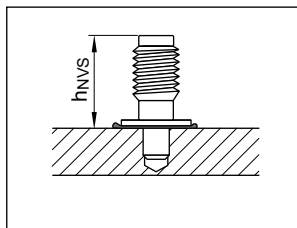

h_{NVS} = 15.7–16.8 mm

X-CRM8-15-12

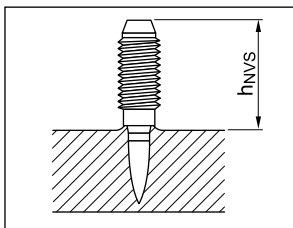

h_{NVS} = 16–20 mm

X-EM8 H-15-12

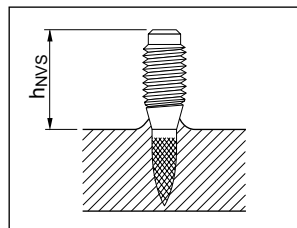

h_{NVS} = 15.5–19.5 mm

Tighten the disk

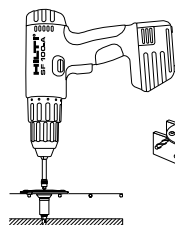

Tightening torque

T_{rec} = max. 8 Nm

Tightening tool:

- Screwdriver with torque release coupling (TRC)
- 5 mm Allen-type bit

Hilti	Torque setting
Screwdriver	
SF 121-A	6–10
SF 150-A	5–8
SF 14	5–8
SF 14-A	6–10
SF 18-A	5–8
SFC 18-A	5–8
SF 22-A	5–8



X-GR Grating Fastening System

Product data

Dimensions

X-GR

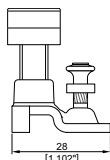
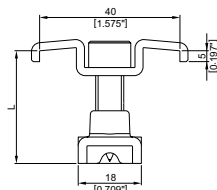

X-R 20-4.0 Zn P8

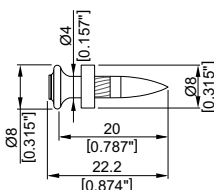

General information

Material specifications

Screw:
 Carbon steel
 Zinc coating: Duplex* coated
 Nail:
 Stainless steel: CrMnMo Alloy and zinc coated

Upper part:
 Carbon steel: DD11
 Zinc coating: Duplex* coated

Bottom part:
 Carbon steel: S315MC
 Zinc coating: Duplex* coated

*) 480 h salt spray test per DIN 50021 and 10 cycles
 Kesternich test per DIN 50018/2.0 (comparable to 45 µm HDG steel)

Recommended fastening tools

DX 460 GR with **X-460-F8GR**
 fastener guide

See **X-GR fastener program** in the next pages and **Tools and equipment** chapter for more details.

Application

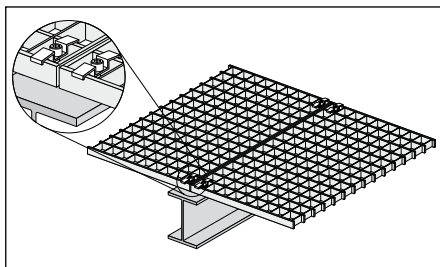

Fastening of grating

For fastenings exposed to weather and mildly corrosive conditions.

Not for use in marine atmospheres (upstream)!



Load data

Recommended tensile loads N_{rec} [kN]

$N_{rec} = 0.8 \text{ kN (180 lb)}$

Notes/Conditions:

- Tensile loading is limited by plastic deformation of the saddle clip
- X-GR resists shear by friction and is not suitable for explicit shear load designs

Application requirements

Thickness of base material

$t_{II} \geq 4 \text{ mm (0.157"')}$

Thickness of fastened material

Grating height: $H_G = 25\text{--}40 \text{ mm (0.98"'\text{--}1.57"')$

Grating opening types

Bearing bar spacing (a)

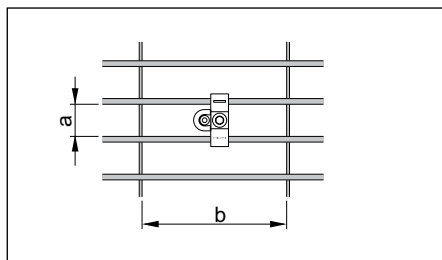

a from 25 to 32 mm (1" to 1 1/4")

Cross bar spacing (b)

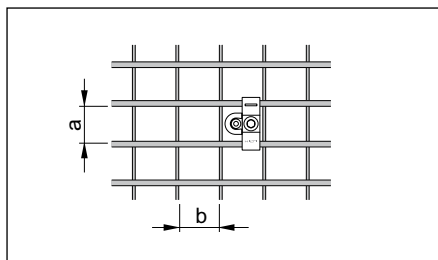

b \geq 30 mm (1.18")

Edge distances

$c \geq 15 \text{ mm (0.59"')}$

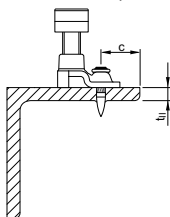

Corrosion information

For fastenings exposed to weather and mildly corrosive conditions. **Not for use in marine atmospheres (upstream)** or in heavily polluted environments.

Application limits

X-GR with DX 460

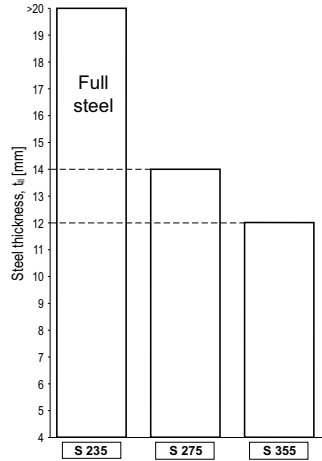
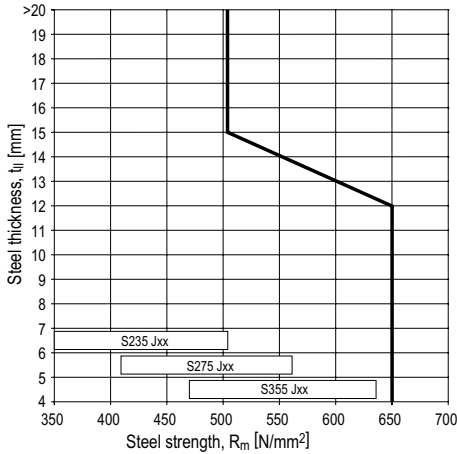

- S235: No application limit
- S275: Full coverage of grade up to 14mm base material thickness
- S355: Full coverage of grade up to 12mm base material thickness

Fastener selection

Fastener	Item no.	L mm (inch)	Grating height mm (inch)
X-GR 25/30	2106415	32 (1.26 ^{''})	25–30 (0.98 ^{''} –1.18 ^{''})
X-GR 1 ¹ / ₄ ^{''}	2106416	34 (1.34 ^{''})	27–32 (1.06 ^{''} –1.26 ^{''})
X-GR 35/40	2106417	42 (1.65 ^{''})	35–40 (1.38 ^{''} –1.57 ^{''})

F

Cartridge selection and tool energy setting

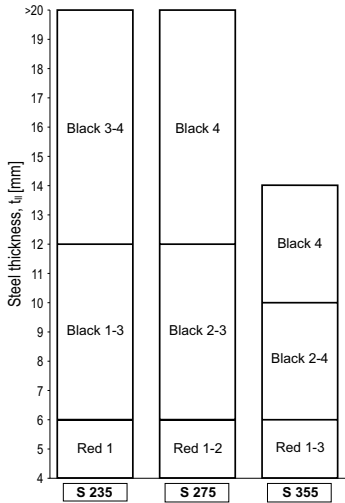

DX 460 with 6.8/11M cartridges

Fastening quality assurance

Tighten the screw

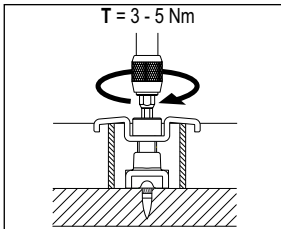

$T_{rec} = 3-5 \text{ Nm}$ (2.2-3.7 ft-lb)

Tightening tool:

- Screwdriver with torque release coupling (TRC)
- 6 mm Allen-type bit

Hilti screwdriver	Torque setting
SF 121-A	4-7
SF 150-A	3-5
SF 14	3-5
SFC 14-A	4-7
SF 18-A	3-5
SFC 18-A	3-5

Fastening inspection

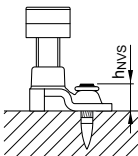

$h_{NVS} = 9-10.5 \text{ mm}$ (0.35"-0.41")

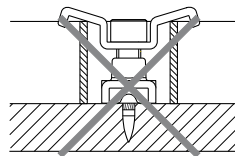

The saddle of the fastener should not be bent, see installation instruction above.

X-PGR-RU Grating Fastening System (Pre-drilled)

Product data

Dimensions

X-PGR-RU

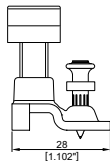
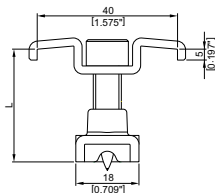

X-CR 20-4.5R P8

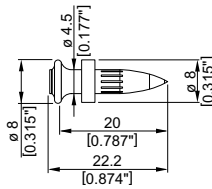

General information

Material specifications

Screw:

Carbon steel

Zinc coating: Duplex* coated

Nail:

Stainless steel: CrNiMo Alloy

Upper part:

Carbon steel: DD11

Zinc coating: Duplex* coated

Bottom part:

Carbon steel: S315MC

Zinc coating: Duplex* coated

*) 480 h salt spray test per DIN 50021 and 10 cycles
Kesternich test per DIN 50018/2.0 (comparable to 45 µm HDG steel)

Recommended fastening tools

DX 460 GR with **X-460-F8GR**
fastener guide

See **X-PGR-RU fastener program** in the next pages and **Tools and equipment** chapter for more details.

Application

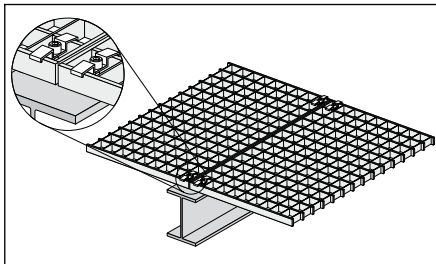

Fastening of grating

For fastenings exposed to weather and mildly corrosive conditions.

Not for use in marine atmospheres (upstream)!

Load data

Recommended tensile loads N_{rec} [kN]

$N_{rec} = 0.8 \text{ kN (180 lb)}$

Notes/Conditions:

- Tensile loading is limited by plastic deformation of the saddle clip
- X-PGR-RU resists shear by friction and is not suitable for explicit shear load designs

Application requirements

Thickness of base material

$t_{II} \geq 6 \text{ mm (0.24"')}$

Thickness of fastened material

Grating height: $H_G = 25\text{--}40 \text{ mm (0.98"'\text{--}1.57"')$

Grating opening types

Bearing bar spacing (a)

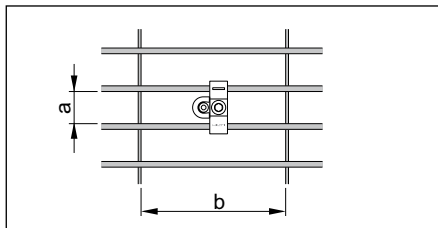

a from 25 to 32 mm (1" to 1 1/4")

Cross bar spacing (b)

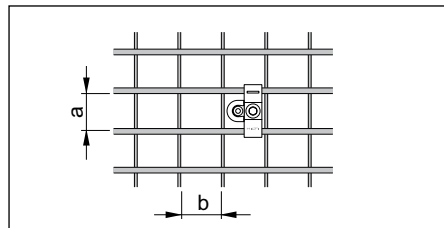

b $\geq 30 \text{ mm (1.18"')}$

Edge distances

$c \geq 15 \text{ mm (0.59"')}$

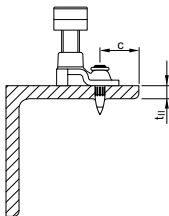

Corrosion information

For fastenings exposed to weather and mildly corrosive conditions. **Not for use in marine atmospheres (upstream)** or in heavily polluted environments.

Application limits

Application limits

X-PGR-RU with DX 460 (pre-drilled)

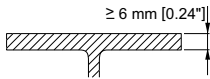

- $t_{||} \geq 6 \text{ mm [0.24"]}$
- $350 \text{ N/mm}^2 \leq \text{Steel strength, } R_m \leq 630 \text{ N/mm}^2$

Fastener selection and system recommendation

Fastener program

Fastener	Item no.	L mm (inch)	Grating height mm (inch)
X-PGR-RU 25/30	2061313	32 (1.26 ^{''})	25–30 (0.98 ^{''} –1.18 ^{''})
X-PGR-RU 1 ¹ / ₄ ''	2061314	34 (1.34 ^{''})	27–32 (1.06 ^{''} –1.26 ^{''})
X-PGR-RU 35/40	2061315	42 (1.65 ^{''})	35–40 (1.38 ^{''} –1.57 ^{''})

Cartridge selection and tool energy setting

DX 460 with 6.8/11M red cartridges, power setting 1–2

Fastening quality assurance

Installation

Pre-drill



Pre-drill with TX-PGR-RU-4/10-93 step shank drill bit (Item no. 2061802), until shoulder grinds a shiny ring (to ensure proper drilling depth).

Tighten the screw

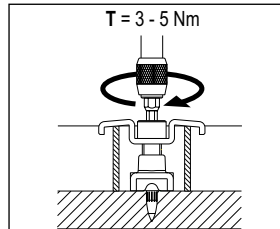

$T_{rec} = 3-5 \text{ Nm}$ (2.2-3.7 ft-lb)

Tightening tool:

- Screwdriver with torque release coupling (TRC)
- 6 mm Allen-type bit

Hilti screwdriver	Torque setting
SF 121-A	4-7
SF 150-A	3-5
SF 14	3-5
SFC 14-A	4-7
SF 18-A	3-5
SFC 18-A	3-5

Fastening inspection

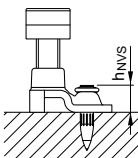

$h_{NVS} = 8-10 \text{ mm}$ (0.31"-0.39")

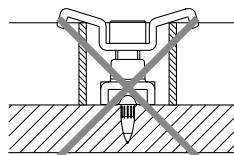

The saddle of the fastener should not be bent, see installation instruction above.

These are abbreviated instructions which may vary by application.
ALWAYS review/follow the instructions accompanying the product.

X-MGR Grating Fastening System

Product data

Dimensions

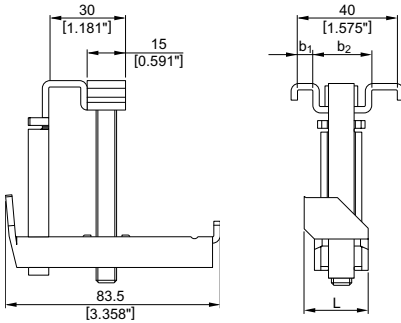

General information

Material specifications

Screw:	
Carbon steel	
Zinc coating:	60 µm HDG
Upper part:	
Carbon steel:	SPCC-S
Zinc coating:	65 µm HDG
Bottom part:	
Carbon steel:	SPCC-S
Zinc coating:	65 µm HDG
Nut:	
Carbon steel	
Zinc coating:	45 µm HDG
Nut-holder:	
Stainless steel:	SS304

Recommended fastening tools

SF 121-A, SF150-A, SF 14, SFC 14-A , SF 18-A, SFC 18-A, SF 22-A

See **X-MGR fastener program** in the next pages and **Tools and equipment** chapter for more details.

Application

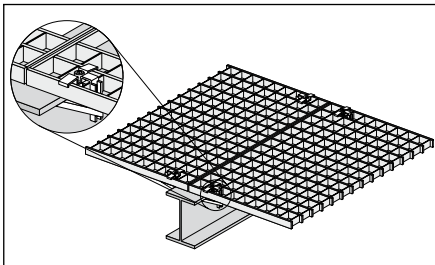

Fixing of grating

For fastenings exposed to weather and mildly corrosive conditions.

Not for use in marine atmospheres (upstream)!



Load data

Recommended tensile loads N_{rec} [kN]

$N_{rec} = 0.6 \text{ kN (135 lb)}$

Notes/Conditions:

- Tensile loading is limited by plastic deformation of the saddle clip
- X-MGR resists shear by friction and is not suitable for explicit shear load designs

Application requirements

Thickness of base material

$t_{II} = 3 - 25 \text{ mm (0.118 - 0.984")}$

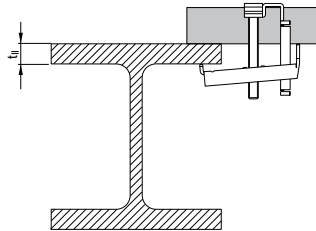

Thickness of fastened material

Grating height:

$H_G = 25 - 40 \text{ mm (0.98" - 1.57")}$

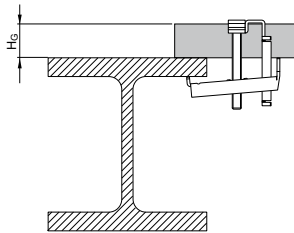

Total fastening height

$H_G + t_{II} \leq 65 \text{ mm (2.56")}$

Grating opening types

Fastener	a mm (inch)	b mm (inch)	c mm (inch)
X-MGR M60	30 (1.18")	$\geq 30 (1.18")$	$\leq 3 (0.118")$
X-MGR W60	25 (0.98")	$\geq 30 (1.18")$	$\leq 4.8 (3/16")$

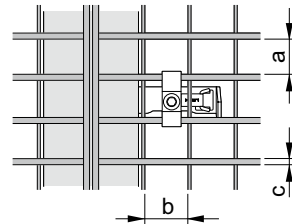

Spacing and edge distances

No general restriction exists.

Corrosion information

For fastenings exposed to weather and mildly corrosive conditions. **Not for use in marine atmosphere (Upstream)** or in heavily polluted environment.

Fastener selection and system recommendation

Fastener program

Fastener	Item-no.	b ¹	b ²	L	Steel flange thickness	Grating height	Fastening tool
		mm (inch)	mm (inch)	mm (inch)	t _{fl} mm (inch)		
X-MRG-M60	384233	4 (0.16")	20 (0.79")	29 (1.14")	3–25 (0.12"–0.98")	25–40 (0.98"–1.57")	SF 121-A, SF 150-A
X-MRG-W60	384234	6 (0.24")	24 (0.94")	25 (0.98")	3–25 (0.12"–0.98")	25–40 (0.98"–1.57")	SF 121-A, SF 150-A

Fastening quality assurance

Fastening inspection

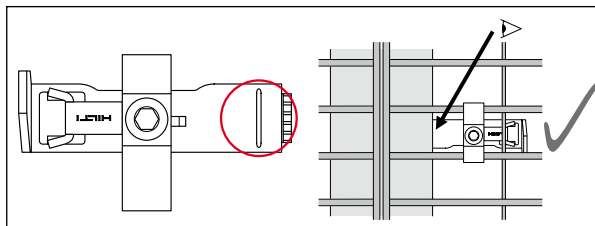

The sign on the clip has to be positioned under the steel flange

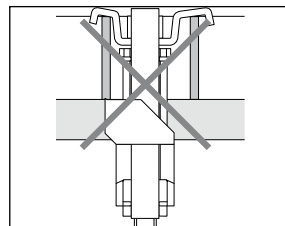

The saddle of the fastener should not be bent, see installation instructions below.

Tighten the screw

T = 5 - 8 Nm

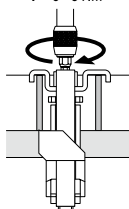

T_{rec} = 5–8 Nm (3.7–5.9 ft-lb)

Hilti screwdriver

Torque setting

SF 121-A	6–10
SF 150-A	5–8
SF 14	5–8
SFC 14-A	6–10
SF 18-A	5–8
SFC 18-A	5–8
SF 22-A	5–8

X-FCP Checker Plate Fastening System

Product data

Dimensions

X-FCP-R 5/10

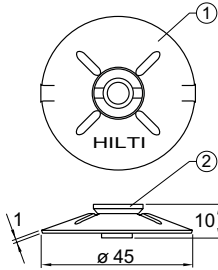

X-FCP-F 5/10

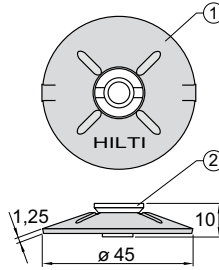

General Information

Material specifications

See fastener selection for more details.

Recommended fastening tools

See **X-FCP fastener program** in the next pages and **Tools and equipment chapter** for more details.

Approvals

LR: X-FCP
 ABS, LR: X-FCP-R
 ABS: X-FCP-F



X-FCP Sealing ring

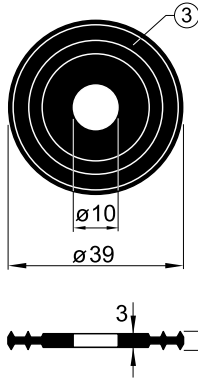

X-CRM8-15-12 FP10

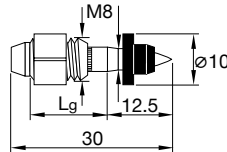

X-CRM8-9-12 P8

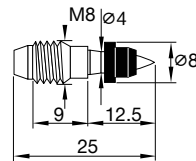

X-CRM8-9-12 FP10

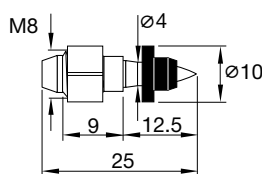

X-CRM8-15-12 P8

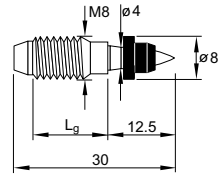

Application

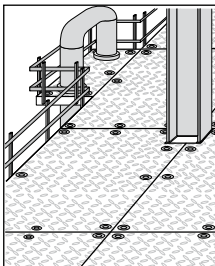

Chequer plate

Load data

Recommended loads:

$N_{rec} = 1.8 \text{ [kN]}$

Conditions:

- Limited by the strength of the X-CRM8 threaded stud.
- Recommended loads are valid for fastenings of steel and aluminium with 20 mm pre-drilling.
- **X-FCP-F** and **X-FCP-R** are not intended for shear loading.

Application requirements

Thickness of base material

X-CRM8

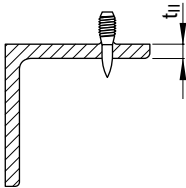

Minimum steel thickness $t_{II} \geq 6 \text{ mm}$

Thickness of fastened material

Thickness of chequer plates: $t_1 \approx 5.0\text{--}13.0 \text{ mm}$

Spacing and edge distances

X-CRM8

Edge distances: $c \geq 15 \text{ mm}$

Spacing: $s \geq 15 \text{ mm}$

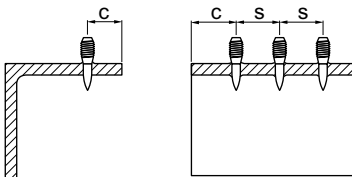

Application limits

DX 76, DX 76 PTR

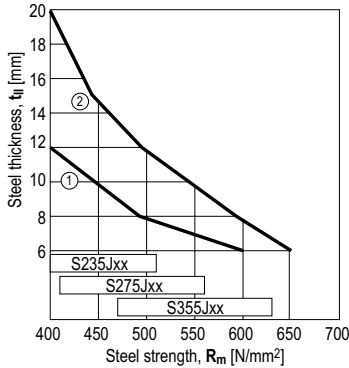

- ① **X-CRM8-__-12 FP10** / DX 76 (impact)
- ② **X-CRM8-__-12 FP10** / DX 76 (co-acting)

$t_{II} \geq 6$ mm

DX 460

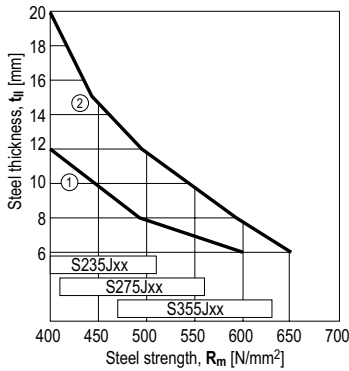

- ① **X-CRM8-__-12 P8** / DX 460 (impact)
- ② **X-CRM8-__-12 P8** / DX 460 (co-acting)

$t_{II} \geq 6$ mm

Note:

For co-acting operation push the fastener all the way back against the piston with a ramrod.

Fastener selection and system recommendation

Fastener program

Application areas

Marine, offshore, petrochemical, calorific (coal, oil) power plants, etc.	Indoors, mildly corrosive environment, or for limited lifetime use
---	--

X-FCP system

X-FCP-R Item no. 308860	X-FCP-F Item no. 308859	Sealing ring	Tools SF 120-A, SF 150-A
Note: Not for use in automobile tunnels, swimming pools or similar environments	Note: Not for use in marine atmosphere or in heavily polluted environment.	Drip-through of water/oil needs to be prevented	

Threaded studs

Designation	Chequer plate thickness	Tools
X-CRM8-15-12	9–13 mm	DX 460, DX 76, DX 76 PTR
X-CRM8-9-12	5– 8 mm	DX 460, DX 76, DX 76 PTR

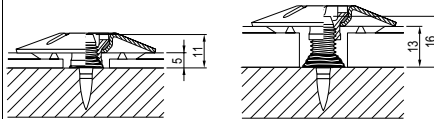

Cartridge selection and tool energy setting

Designation	Tools
6.8/11M red cartridges	DX 460
6.8/18M yellow cartridges	DX 76, DX 76 PTR

Tool energy adjustment by setting tests on site.

Material and coatings

X-FCP system

	X-FCP-R		X-FCP-F		All Systems
	① Disk	② Screw	① Disk	② Screw	③ Sealing ring
Material designation	X5CrNiMo17122	X2CrNiMo17132	ST2K40 BK	9SMnPb28 K	Neoprene, black
Coating	none	none	Duplex *	Duplex *	

*) 480 h Salt spray test per DIN 50021 and 10 cycles Kesternich test per DIN 50018/2.0 (comparable to 45 µm HDG steel)

Threaded studs CRM8

	X-CR shank	CRM8 threaded sleeve	
Material designation	Stainless steel wire, CR 500 (A4 / AISI316)	X2CrNiMo17132 X5CrNiMo17122+2H (A4 / AISI316)	
Coating	none	none	

Fastening quality assurance

Fastening inspection

X-CRM8-9-12

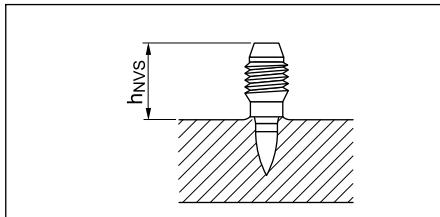

$h_{NVS} = 13 \pm 2 \text{ mm}$

X-CRM8-15-12

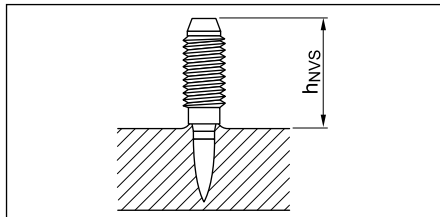

$h_{NVS} = 18 \pm 2 \text{ mm}$

Plates must be pre-drilled or pre-punched

$\varnothing 18\text{-}20 \text{ mm}$

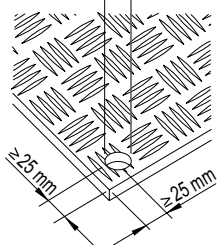

Tighten the disk

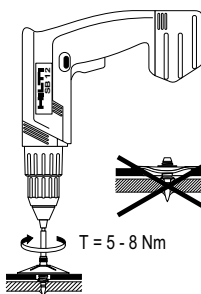

Tightening torque
 $T_{rec} = 5\text{-}8 \text{ Nm}$

Tightening tool:

- Screwdriver with torque release coupling (TRC)
- S-NSX 2.8 x 15 bit

Hilti Screwdriver	Torque setting
SF 120-A	TRC 5.5-7
SF 150-A	TRC 8-9

SF 120-A TRC 5.5-7
SF 150-A TRC 8-9



X-IE Wall Insulation Fastener

Product data

Dimensions

X-IE 6

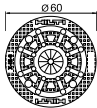

X-IE 9

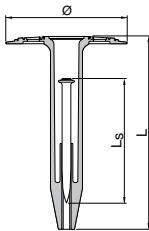
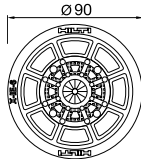

HDT 90

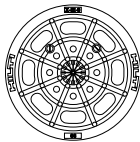

General information

Material specifications

Plate:	X-IE 6 – HDPE, colourless X-IE 9 – HDPE, black (BK)
Nail:	Carbon steel shank: HRC 58 Zinc coating: 5–20 µm

Recommended fastening tools

DX 460 IE and DX 460 IE XL

See **X-IE fastener program** in the next pages and **Tools and equipment** chapter for more details.

Approvals

SOCOTEC WX 1530 (France)

Comment: European Technical Approvals for the fasteners **XI-FV** (ETA-03/0004, DOP no. Hilti-DX-DOP-002) and **SX-FV** (ETA-03/0005) for use in ETICS are available.

For more information please contact Hilti.

Note: technical data presented in these approvals and design guidelines reflect specific local conditions and may differ from those published in this handbook.

Applications

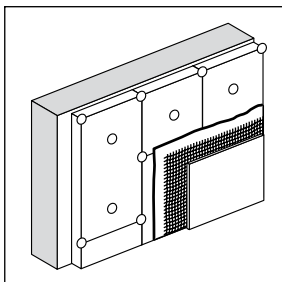

Composite thermal insulation

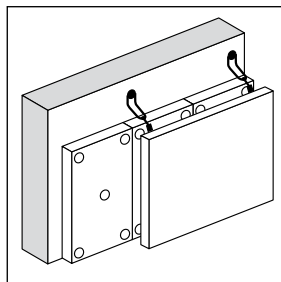

Insulation behind curtain walls

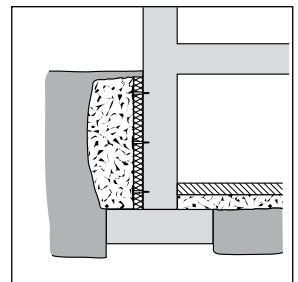

Moisture barriers / drainage plates

Fastener program

Fastener selection

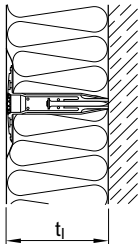

Select Fastener Length $L = t_i$

In general:

The fastener length L must be equal to the thickness t_i of mineral wool and EPS insulation material, as shown in the drawing above.

Exceptions:

For mineral wool of intermediate thicknesses use next shorter X-IE.

Not for use with PUR, PIR, XPS, Multi layer boards or similar hard material not listed on this page.

Note:

For soft mineral wool use X-IE 9. Or X-IE 6 with HDT 90 / HDT 90 BK.

Designation	Fastener X-PH Ls	Item no.	Insulation thickness t_i [mm]
X-IE 6-25	X-PH 47	2041714	25
X-IE 6-30	X-PH 52	2041715	30
X-IE 6-35	X-PH 52	2041716	35
X-IE 6-40	X-PH 52	2041717	40
X-IE 6-50	X-PH 62	2041718	50
X-IE 6-60	X-PH 62	2041719	60
X-IE 6-70	X-PH 62	2041740	70
X-IE 6-75	X-PH 62	2041741	75
X-IE 6-80	X-PH 62	2041742	80
X-IE 6-90	X-PH 62	2041743	90
X-IE 6-100	X-PH 62	2041744	100
X-IE 6-120	X-PH 62	2041745	120
X-IE 6-140	X-PH 62	2041393	140
X-IE 6-150	X-PH 62	2048523	150
X-IE 6-160	X-PH 62	2041394	160
X-IE 6-180	X-PH 62	2041395	180
X-IE 6-200	X-PH 62	2041396	200
X-IE 9-60 BK	X-PH 62	2041746	60
X-IE 9-80 BK	X-PH 62	2041747	80
X-IE 9-90 BK	X-PH 62	2041748	90
X-IE 9-100 BK	X-PH 62	2041749	100
X-IE 9-120 BK	X-PH 62	2041750	120
X-IE 9-140 BK	X-PH 62	2041751	140
X-IE 9-160 BK	X-PH 62	2041752	160
X-IE 9-180 BK	X-PH 62	2041753	180
X-IE 9-200 BK	X-PH 62	2041754	200

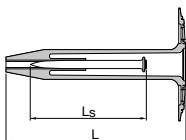

System recommendation

Tool

DX 460 IE and DX 460 IE XL

Cartridge selection and tool energy setting

Cartridge recommendation:	Steel:	6.8/11M yellow or red cartridge
	Concrete	6.8/11M yellow or red cartridge
	Masonry:	6.8/11M yellow or green cartridge

Tool energy adjustment by setting tests on site.

Application requirements

Thickness of base material

Concrete:	$h_{\min} = 80 \text{ mm}$
Steel:	$t_{II} \geq 4 \text{ mm}$

Thickness of fastened material

Insulation thickness: $t_I = 25\text{--}200 \text{ mm}$

Spacing and edge distances

For setting instructions please inquire at the insulation material supplier.

If recommendations from suppliers are not available, please use minimum 3 pcs of X-IE fasteners per insulation material and ≥ 5 pcs of X-IE fasteners per m^2

Application limits

Concrete:	$f_{cc} = 15\text{--}45 \text{ N/mm}^2$	(aggregate size $\leq 32 \text{ mm}$)
Sand-lime masonry:	$f_{cc} = 15\text{--}45 \text{ N/mm}^2$	
Clinker brick work:	$f_{cc} = 28\text{--}45 \text{ N/mm}^2$	
Steel:	$f_u = 360\text{--}540 \text{ N/mm}^2$	($t_{II} = 4\text{--}6 \text{ mm}$)

Load data

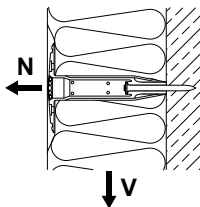

Recommended loads

	Insulation thickness t_I [mm]				
	40	50	60–70	75	80–200
X-IE 6	Shear, V_{rec} [N]				
Polystyrol - EPS [30 kg/m ³]	150	250	300	325	350
X-IE 6	Pullover, N_{rec} [N]				
Polystyrol - EPS [30 kg/m ³]	250	290	300	300	300
X-IE 9, HDT 90	Pullover, N_{rec} [N]				
Mineral wool [$\geq 7.5 \text{ kN/m}^2$]*	–	–	135	135	135
Mineral wool [$\geq 15 \text{ kN/m}^2$]*	–	–	250	250	250

*) Tensile Strength σ_{mt} according to DIN EN 1607

When base material properties are questionable, jobsite qualification is necessary

Fastening quality assurance

Installation

1. Insulation material suitability.



2. Load the X-IE on the tool and push the X-IE all the way into the insulation.

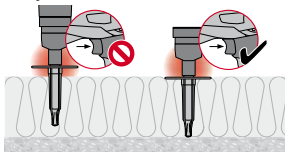

3. Fasten the X-IE into the rib of the composite deck only NOT the trough.

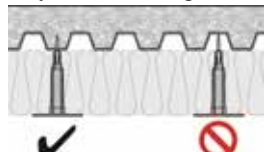

Important: This description of the installation process is only for illustration purposes. The installation must always follow the instructions for use provided with the product.

Fastening inspection

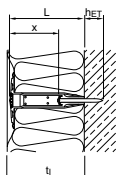

	Insulation thickness t_i [mm]													
	40	50	60	70	75	80	90	100	120	140	150	160	180	200
$h_{ET} = 24-29$ mm														
x_{min} [mm]	9	9	19	29	34	39	49	59	79	99	109	119	139	159
x_{max} [mm]	14	14	24	34	39	44	54	64	84	104	114	124	144	164

Check with the gauge immediately after fastening

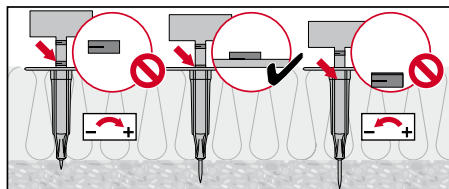

Adjust the power setting if required

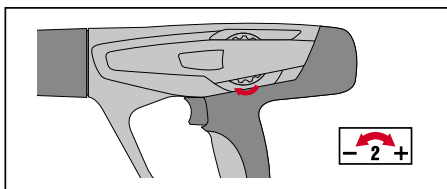

These are abbreviated instructions which may vary by application. **ALWAYS** review/follow the instructions accompanying the product.

X-SW 30, X-SW 60 Soft Washer Fastener

Product data

Dimensions

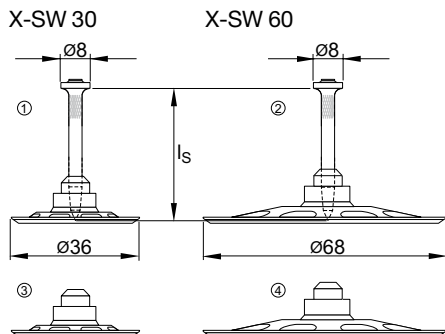

General information

Material specifications

Plate:	PE
Nail:	Carbon steel shank: HRC 52.5
	Zinc coating: 5–13 μm

Recommended fastening tools

DX 460, DX 36, DX 2, DX-E 72, DX 460-MX

See **X-SW fastener program** in the next pages and **Tools and equipment** chapter for more details.

Applications

Examples

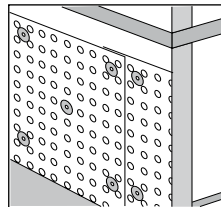

Membranes and drainage plates

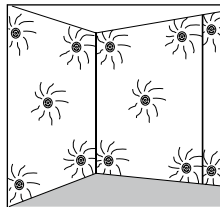

Insulation up to 30 mm thick

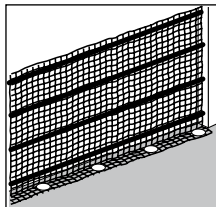

Nets, fabric and similar

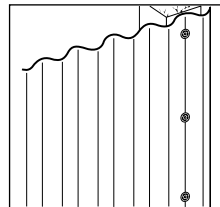

Plastic corrugated sheets



Load data

Recommended loads

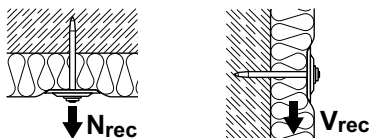

Design conditions:

1. Minimum 5 fastenings per fastened unit.
2. Predominantly static loading.
3. Design loads valid for nail pull-out strength. Fastened material has to be considered separately.
4. Valid for concrete C 30/37.

	Tension, N_{rec} [kN]	Shear, N_{rec} [kN]
DX	0.3	0.3
GX (with X-GN 39 MX)	0.1	0.1

Application requirements

Thickness of base material

Concrete: $h_{min} = 80$ mm

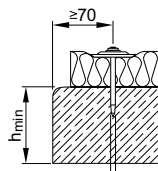

Steel: $t_{II} \geq 4$ mm

(Not recommended for X-GN 39 MX)

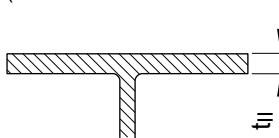

Thickness of fastened material

Membranes, nets, etc.: $t_I \leq 25$ mm (X-GN 39 MX, $t_I \leq 20$ mm)

Insulation: $t_I \leq 30$ mm (Not recommended for X-GN 39 MX)

Spacing and edge distances

For setting instructions please inquire at the supplier of fastened material.

Fastener selection and system recommendation

Fastening to concrete

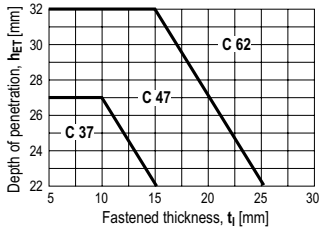

- **X-SW 30** for stronger, less damageable material.
- **X-SW 60** for more easily damaged material (i.e. aluminium foil, nets, paper, etc.)
- Select nail lengths (**C 37**, **C 47** and **C 62**) according to base material conditions and fastened thickness

Fastener program

Designation	Item no. Packs of 100/150	Packs of 400/500	L _s [mm]	Tools
				Designation
① X-SW 30-C 37	40643	40614	37	DX 460, DX 36, DX 2, DX-E 72
① X-SW 30-C 47	40644	40615	47	DX 460, DX 36, DX 2, DX-E 72
① X-SW 30-C 62	40645	40616	62	DX 460, DX 36, DX 2, DX-E 72
② X-SW 60-C 37	40617		37	DX 460, DX 36, DX 2, DX-E 72
② X-SW 60-C 47	40618		47	DX 460, DX 36, DX 2, DX-E 72
② X-SW 60-C 62	40619		62	DX 460, DX 36, DX 2, DX-E 72
③ X-SW 30	371370			DX 460-MX with collated
③ X-SW 60	371371			X-C nails (3.5 mm shank dia.)
				GX-120 with X-GN 39 MX nails

Cartridge selection and tool energy setting

Cartridge recommendation: Concrete **6.8/11M yellow or red**

Masonry: **6.8/11M green**

Tool energy adjustment by setting tests on site.

X-FS Form Stop

Product data

Dimensions

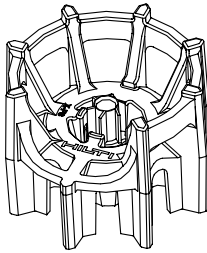
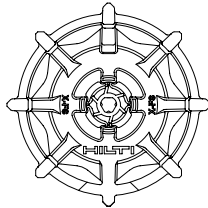
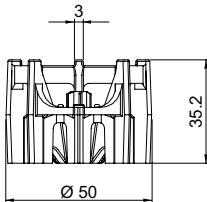

General information

Material specifications

Nail: zinc coating: 5–20 µm

Recommended fastening tools

DX 460, DX 36, DX 2, DX 460-MX

See **X-FS fastener program** in the next pages and **Tools and equipment** chapter for more details.

Applications

Examples

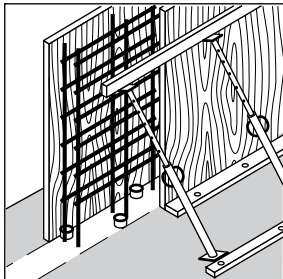

Positioning concrete forms on concrete surfaces. Leave in place, grey polyethylene is **non rusting, nearly invisible and non-conductive**.

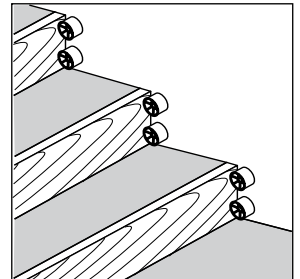
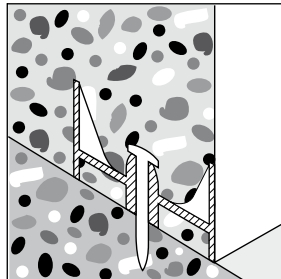

X-FS is suitable and usable for minor forming applications

Load data

Recommended working loads

$V_{rec} = 400 \text{ N}$

(predominantly static, however, vibration from concrete compacting is allowed)

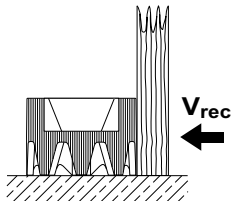

Application requirements

Thickness of base material

Concrete: $h_{min} = 80 \text{ mm}$

Spacing and edge distances

Spacing and edge distances depending on job site requirements.

Corrosion information

For temporary fixations no restrictions exist.

Fastener program

Fastener				Tools
Designation	Item no.	L_s [mm]	Nail shank diameter [mm]	Designation
① X-FS C 52 *	407346	52	3.5	DX 460, DX 36, DX 2
② X-FS MX **	408022			DX 460-MX

* For unusual applications, X-FS available with other nails on special order

** X-FS without nail for fastening with collated nails.

Cartridge selection and tool energy setting

Cartridge recommendation:	Steel:	6.8/11M red cartridge
	Concrete:	6.8/11M yellow or red cartridge
	Masonry:	6.8/11M yellow or green cartridge

Tool energy adjustment by setting tests on site.

X-HS Threaded Hanger and X-CC Loop Hanger Systems

Product data

Dimensions

X-HS DKH ①

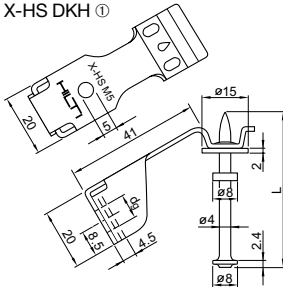

X-HS U ②

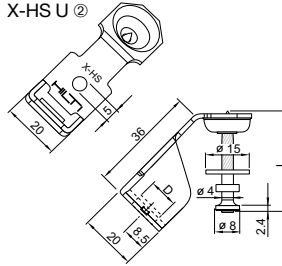

X-CC U ③

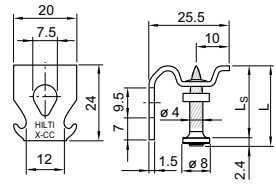

DKH 48 P8S15

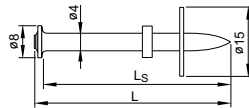

X-U_P8

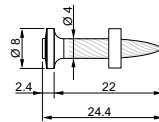

X-CC DKH 48 ③

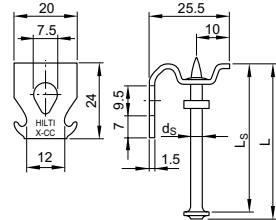

X-CC CS

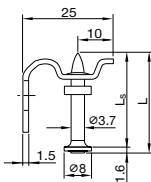

X-CS_P8

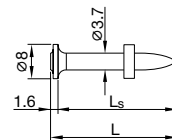

General information

Material specifications

Carbon steel shank:	HRC 58	X-HS M_DKH, X-HS M/W_U, X-CC_U
	HRC 56	X-CC_CS
X-HS:	Zinc coating:	10 µm
X-CC U:	Zinc coating:	2.5 µm
X-CC CS :	Zinc coating:	≥ 5 µm
X-U / DKH Nail:	Zinc coating:	5–20 µm
X-CS Nail:	Zinc coating:	5–20 µm

Recommended fastening tools

DX 460-F8, DX 351-F8, DX 36, DX 2, DX E72

See **X-HS** and **X-CC** fastener program in the next pages and **Tools and equipment** chapter for more details.

Approvals

SOCOTEC (France): X-HS/X-CC with X-DKH

Lloyds Register: X-HS

ICC, UL, FM: X-HS W6/10

Note: technical data presented in these approvals and design guidelines reflect specific local conditions and may differ from those published in this handbook.

Applications

Examples

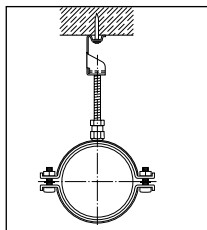

Threaded rod attachments to concrete and steel

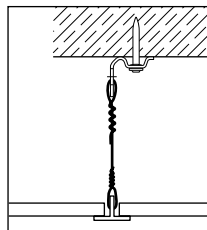
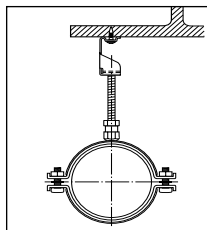

Wire attachments to concrete and steel

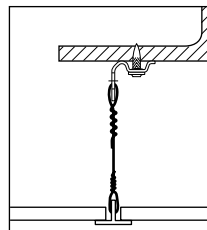

Load data

Recommended loads

Concrete (DX-Kwik with pre-drilling) or steel

X-HS

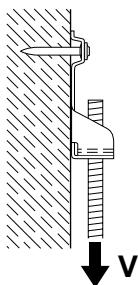
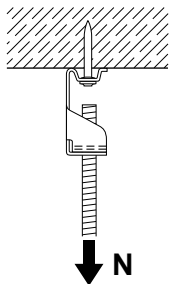

Fastener designation	$N_{rec} = V_{rec}$ [kN]	Base material
X-HS _ DKH 48	0.9	Concrete
X-HS _ U19	0.9	Steel
X-CC DKH 48	0.9	Concrete
X-CC U16	0.9	Steel

Conditions:

- Predominantly static loading.
- Concrete C20/25–C50/60
- Strength of fastened material is not limiting.
- Observance of all application limitations and recommendations (especially pre-drilling requirements).

X-CC

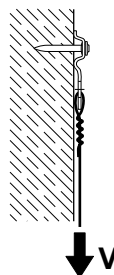
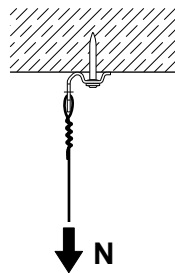

Concrete (DX Standard without pre-drilling)

X-HS

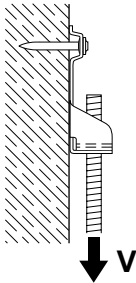
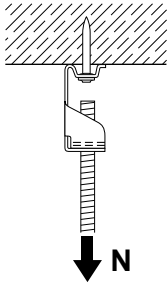

Fastener designation	N_{rec} [kN]	V_{rec} [kN]	h_{ET} [mm]
X-HS_U32	0.4	0.4	27
X-HS_U27	0.3	0.3	22
X-HS_U22	0.2	0.2	18
X-CC_U27	0.2*	0.3	22
X-CC_U22	0.15*	0.2	18
X-CC_CS27	0.2	0.3	22
X-CC_CS22	0.15	0.2	18

*) eccentric loading considered

Conditions:

- Minimum 5 fastenings per fastened unit (normal weight concrete).
- All visible failures must be replaced.
- With lightweight concrete base material and appropriate washers, greater loading may be possible, please contact Hilti.
- Predominantly static loading.
- Observance of all application limitations and recommendations.

X-CC

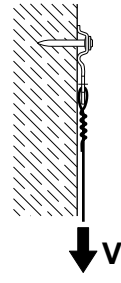
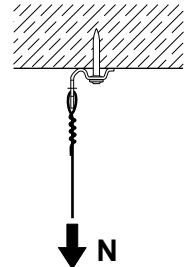

Application requirements

Thickness of base material

Concrete

DX-Kwik

(with pre-drilling) $h_{min} = 100 \text{ mm}$

DX Standard

(w/o pre-drilling) $h_{min} = 80 \text{ mm}$

Steel

$t_{fl} \geq 4 \text{ mm}$

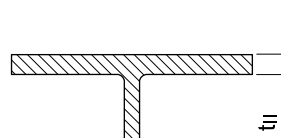

Spacing and edge distances

Minimum spacing and edge distances: See corresponding nail data sheet of X-U and X-DKH.

Corrosion information

These zinc-coated fasteners are not suitable for long-term service outdoors or in otherwise corrosive environments.

For further detailed information on corrosion see relevant chapter in **Direct Fastening Principles and Technique** section.

Application limits

Fastening to steel – X-HS U19 with DX351

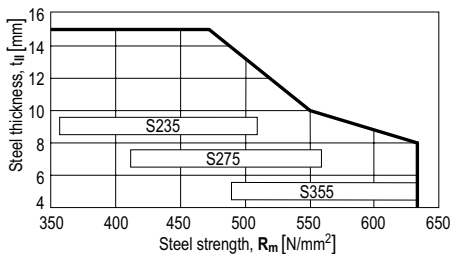

Fastener selection

Program, technical information

Base material	Fastener Designation	Shank Ø d_s [mm]	Shank length L_s [mm]	L [mm]	Tools
① Concrete pre-drilled	X-HS _ DKH 48 P8S15	4.0	48	50.0	DX 460-F8
② Concrete	X-HS _ U 32 P8S15	4.0	32	34.4	DX 460-F8, DX 351-F8, DX 36, DX 2
	X-HS _ U 27 P8S15	4.0	27	29.4	
	X-HS _ U 22 P8S15	4.0	22	24.4	
Steel	X-HS _ U 19 P8S15	4.0	19	21.4	
③ Concrete pre-drilled	X-CC DKH 48 P8S15	4.0	48	50.0	DX 460-F8
③ Concrete	X-CC U 27 P8	4.0	27	29.4	DX 460-F8, DX 351-F8, DX 36, DX 2
	X-CC U 22 P8	4.0	22	24.4	
	X-CC U 16 P8	4.0	16	18.4	
Steel	X-CC U 16 P8	4.0	16	18.4	

Type of threading: M = metric; W6, W10 = Whitworth 1/4"; 3/8"

X-HS order information

Item no.	Designation	Item no.	Designation
361788	X-HS M6 U32 P8 S15	386214	X-HS M8 U19 P8 S15
386223	X-HS M6 U27 P8 S15	386215	X-HS M10 U19 P8 S15
361789	X-HS M8 U32 P8 S15	386217	X-HS W10 U19 P8 S15
386224	X-HS M8 U27 P8 S15	386218	X-HS M6 U22 P8 S15
361790	X-HS M10 U32 P8 S15	386219	X-HS M8 U22 P8 S15
386225	X-HS M10 U27 P8 S15	386222	X-HS W10 U22 P8 S15
386226	X-HS W6 U27 P8 S15	386216	X-HS W6 U19 P8 S15
386227	X-HS W10 U27 P8 S15	386220	X-HS M10 U22 P8 S15
386213	X-HS M6 U19 P8 S15	386221	X-HS W6 U22 P8 S15

Type of threading: M = metric; W6, W10 = Whitworth 1/4"; 3/8"

X-CC order information

Item no.	Designation
386229	X-CC U22 P8
386230	X-CC U27 P8
299937	X-CC DKH P8 S15
386228	X-CC U16 P8
2006454	X-CC CS22 P8
2005065	X-CC CS27 P8

Cartridge selection

Cartridge recommendation:

Steel:	6.8/11M red cartridge	$t_{II} \geq 6 \text{ mm}$
	6.8/11M green cartridge	$t_{II} < 6 \text{ mm}$
Concrete:	6.8/11M yellow cartridge	on green/fresh and standard concrete
	6.8/11M red cartridge	on precast, old and hard concrete

Tool energy adjustment by setting tests on site.

Fastening quality assurance

Installation

X-HS

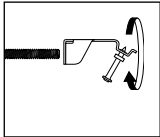

1. Attach the threaded rod to the X-HS before fastening

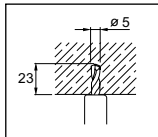

2. For **DKH 48** pre-drill ($\varnothing 5 \times 23$)

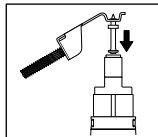

3. Load the assembly into the tool

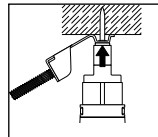

4. Locate the nail, compress the tool, pull the trigger and the fastening is complete

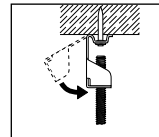

5. Bend the X-HS assembly down to the vertical position

X-CC

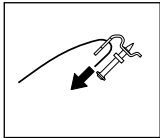

1. Assemble the wire with the **X-CC**

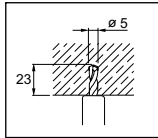

2. For **DKH 48** pre-drill ($\varnothing 5 \times 23$)

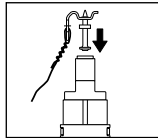

3. Load the assembly into the tool

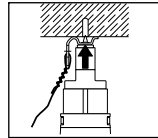

4. Locate the nail, compress the tool, pull the trigger and the fastening is complete

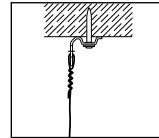

5. Adjust the wire as required

Quality assurance

X-HS

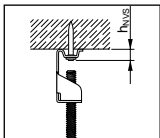

$h_{NVS} = 6-10 \text{ mm}$

X-CC

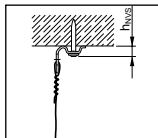

$h_{NVS} = 4-7 \text{ mm}$

These are abbreviated instructions which may vary by application.
ALWAYS review/follow the instructions accompanying the product.

Electrical Hanger Systems X-EHS MX and X-ECC MX

Product data

Dimensions

X-EHS MX

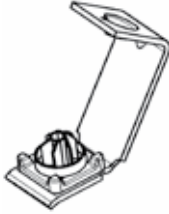

X-ECC MX

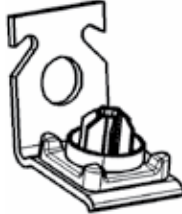

X-GHP 20/24

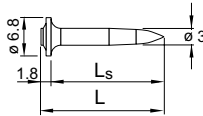

X-EGN 14

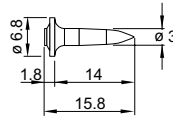

X-U 16/22

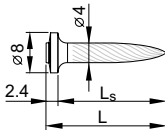

General information

Material specifications

X-EHS MX / X-ECC MX:

Zinc coating: $\geq 2.5 \mu\text{m}$

Recommended fastening tools

GX 120-ME, GX 100-E, DX 460 MX, DX 351 MX

See **X-EHS MX** and **X-ECC MX** fastener program in the next pages and **Tools and equipment** chapter for more details.

Applications

Example

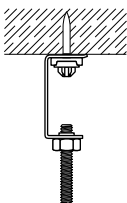

Hanger systems for light cable trays, etc.

- Threaded rod attachments
- Wire attachments

These fasteners are not recommended for fastening of suspended ceilings.

These zinc coated fasteners are not suitable for long-term service outdoors or in otherwise corrosive environments.

Load data

Recommended loads on concrete

Fastener designation	$N_{rec} = V_{rec}$ [kN]
X-EHS MX	0.1
X-ECC MX	0.05 (N_{rec}^*)
	0.1 (V_{rec})

*) eccentric loading considered

Conditions:

- Fastened with X-GHP 20/24 or X-U 22
- Minimum 5 fastenings per fastened unit (normal weight concrete).
- All visible failures must be replaced.
- With lightweight concrete base material and appropriate washers, greater loading may be possible, please contact Hilti.
- Predominantly static loading.
- Observance of all application limitations and recommendations.

Recommended loads on steel

Fastener designation	$N_{rec} = V_{rec}$ [kN]
X-EHS MX, X-ECC MX	0.45

Fastened with X-EGN 14 or X-U 16

Application requirements

Thickness of base material

Concrete		Steel
X-U:	$h_{min} = 80 \text{ mm}$	$t_{II} \geq 4 \text{ mm}$
X-GHP:	$h_{min} = 60 \text{ mm}$	

The diagram illustrates a cross-section of a fastener being installed into a steel plate. The steel plate has a thickness labeled as t_{II} . The fastener is shown as a vertical rod with a horizontal base plate. The steel plate is hatched to indicate its material.

Spacing and edge distances

Spacing and edge distances depending on job site requirements.

Corrosion information

These zinc-coated fasteners are not suitable for long-term service outdoors or in otherwise corrosive environments.

For further detailed information on corrosion see relevant chapter in **Direct Fastening Principles and Technique** section.

Application limits

Fastening to steel

X-EGN 14

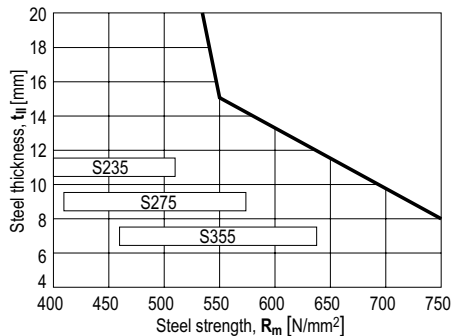

Fastener program

Fastener selection

Base material	Nail			
	Designation	Shank Ø d_s [mm]	Shank length L_s [mm]	L [mm]
Concrete	X-GHP 20 MX	3.0	20	21.8
	X-GHP 24 MX	3,0	24	25,8
	X-U 22 MX	4.0	22	24.4
Steel	X-EGN 14 MX	3.0	14	15.8
	X-U 16 MX	4.0	16	18.4



Fastener selection: Order information

Fastener	Designation	Item no.
Threaded Rod Hanger	X-EHS M4 MX	273367
	X-EHS M6 MX	272073
	X-EHS W6 MX	228341
	X-EHS M8 MX	273368
	X-EHS W10 MX	386468
Ceiling clip	X-ECC MX	228342
GX nails	X-EGN 14 MX	338872
	X-GHP 20 MX	285890
	X-GHP 24 MX	438945
DX Nails	X-U 16 MX	237344
	X-U 22 MX	237346

System recommendation

DX tools: Steel: **6.8/11M yellow or red cartridge**
 Concrete: **6.8/11M yellow cartridge** on green/ fresh and standard concrete
6.8/11M yellow or red cartridge on precast, old and hard concrete

GX 120-ME tool: **gas can GC 20, GC21 and GC22**

GX 100-E tool: **gas can GC 11** (GC 12 in USA)

Tool energy adjustment by setting tests on site.

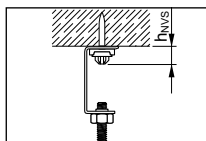
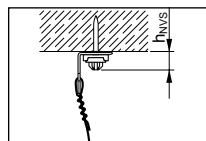
Fastening quality assurance
X-EHS MX

 $h_{NVS} = 4-8 \text{ mm}$
X-ECC MX

 $h_{NVS} = 4-8 \text{ mm}$

X-HS-W - Wire Hanging System

Product data

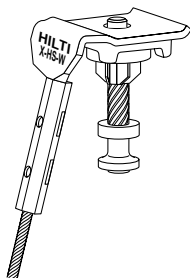
Fasteners/Components Overview

Pre assembled



GX Nails:

X-GHP 20/24

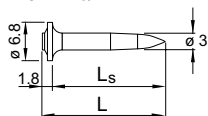

X-EGN 14

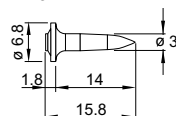

Magazined

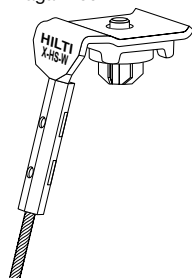

DX Nails:

X-U 16/22/27

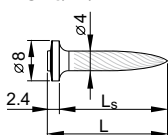

Locking Mechanism

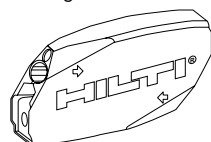

General information

Material specifications

X-HS-W:

Zinc coating $\geq 2.5 \mu\text{m}$

Nail:

Zinc coating 2–20 μm

Carbon steel shank: HRC 58

X-EGN, X-GHP, X-U

Recommended fastening tools

DX 460-F8, DX 351-F8, GX 120-ME

See **X-HS-W fastener program** in the next pages and **Tools and equipment** chapter for more details.

Approvals

CSTB AT 3/09-639

X-HS-W

Applications

Examples



Round Air Ducts



Square Air Ducts



Light weight Cable Trays / Lights



Load data

Recommended loads

DX Standard for concrete

Fastener designation	N_{rec} [kN]	V_{rec} [kN]	h_{ET} [mm]
X-HS-W U27	0.20	0.3	22
X-HS-W U22	0.15	0.2	18
X-HS-W with GHP20/24	0.05	0.1	14

Conditions:

- Minimum 5 fastenings per fastened unit (normal weight concrete).
- All visible failures must be replaced.
- Valid for masonry and concrete – GHP20/24: $f_{cc} \leq 55 \text{ N/mm}^2$
X-U: $f_{cc} \leq 45 \text{ N/mm}^2$
- Predominantly static loading.
- Observance of all application limitations and recommendations.

DX Standard for steel

Fastener designation	N_{rec}	V_{rec}
X-HS-W U16	0.90	0.90
X-HS-W EGN14	0.45	0.45

Conditions:

- Predominantly static loading.
- Observance of all application limitations and recommendations.

Application requirements

Thickness of base material

Concrete

X-U: $h_{min} = 80 \text{ mm}$

X-GHP, X-GN: $h_{min} = 60 \text{ mm}$

Steel

$t_{II} \geq 4 \text{ mm}$

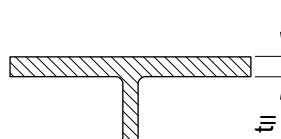

Spacing and edge distances

Spacing and edge distances depending on job site requirements.

Corrosion information

These zinc-coated fasteners are not suitable for long-term service outdoors or in otherwise corrosive environments.

For further detailed information on corrosion see relevant chapter in **Direct Fastening Principles and Technique** section.

Application limits

Concrete

X-GHP 20/24:
concrete strength $f_{cc} \leq 55 \text{ N/mm}^2$

X-U:
concrete strength $f_{cc} \leq 45 \text{ N/mm}^2$

Steel

X-HS-W MX with X-EGN14 MX

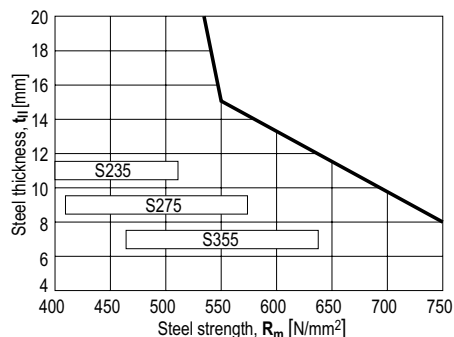

X-HS-W U16 P8

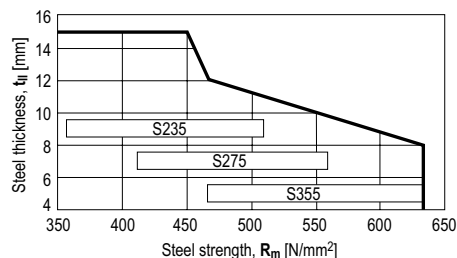

Fastener program

Fastener selection: Possible combinations

Base material	Hanger		Nail		
	Designation	Technology	Designation	Shank Δ d_s [mm]	Shank length L_s [mm]
Concrete	X-HS-W	GX	X-GHP 20 MX	3.0	20
	X-HS-W	GX	X-GHP 24 MX	3.0	24
	X-HS-W	DX	X-U 22 P8	4.0	22
	X-HS-W	DX	X-U 27 P8	4.0	27
Steel	X-HS-W	GX	X-EGN 14 MX	3.0	14
	X-HS-W	DX	X-U 16 MX	4.0	16



Fastener selection: Order information

Fastener		Designation	Item no.
X-HS-W	For DX tools	X-HS-W U16 P8 1m/3ft	387430
		X-HS-W U22 P8 1m/3ft	387431
		X-HS-W U27 P8 1m/3ft	387432
		X-HS-W U16 P8 2m/7ft	387919
		X-HS-W U22 P8 2m/7ft	387920
		X-HS-W U27 P8 2m/7ft	387921
		X-HS-W U16 P8 3m/10ft	387433
		X-HS-W U22 P8 3m/10ft	387434
		X-HS-W U27 P8 3m/10ft	387435
X-HS-W	For GX tools	X-HS-W MX 1m/3ft	387436
		X-HS-W MX 2m/7ft	387922
		X-HS-W MX 3m/10ft	387437

System recommendation

- DX tools: Steel: **6.8/11M red cartridge** for $t_{II} \geq 6$
6.8/11M green cartridge for $t_{II} < 6$
- Concrete: **6.8/11M green or yellow cartridge** on young and standard concrete
6.8/11M red cartridge on pre-cast, old and hard concrete

GX 120-ME tool: **gas can GC 20, GC21 and GC22**

GX 100-E tool: **gas can GC 11** (GC 12 in USA)

Tool energy adjustment by setting tests on site.

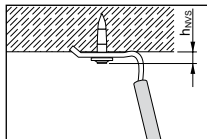
Fastening quality assurance
X-HS-W

$h_{NVS} = 5.5-8.5 \text{ mm}$

NO LIFTING

Do not use for lifting, such as in a crane or pulley situation.

NO MOVEMENT

Hilti hangers are to be used to suspend stationary loads only. Do not use to suspend moving services, or services likely to be subject to movement.

NO JOINING

Hilti hangers must not be used as an in-line joint using a Hilti fastener, or any other joining device. A Hilti hanger assembly must comprise one length of cable and one Hilti fastener only. If a longer length is needed, do not join two assemblies together.

X-EKB, X-ECH Electrical Cable Fasteners

Product data

Dimensions

Single Fastener

X-EKB 8/4-FR

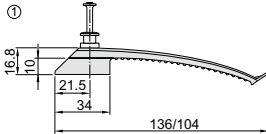

X-EKB 16 (FR)

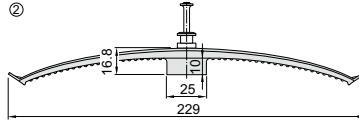

X-U 37 PH

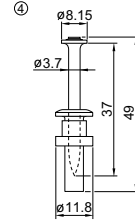

X-ECH-S (FR)

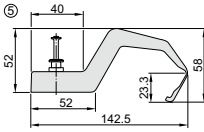

X-ECH-M (FR)

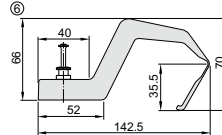

X-ECH-L (FR)

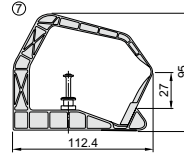

Magazine fastener

X-EKB 4 / 8 / 16 MX (FR)



X-EKB 4 MX (FR)

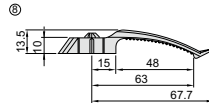

X-ECH-B MX

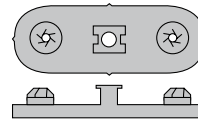

X-ECH-15/30 MX

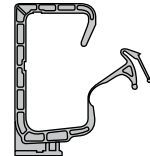

X-GHP 20/24

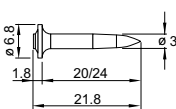

X-GN 27

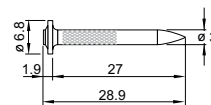

X-EGN 14

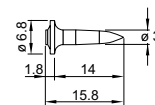

X-U 16/22/27

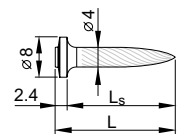

General information

Material specifications

See Fastener selection

Recommended fastening tools

DX 460-F8, DX 351-F8, GX 120-ME, GX 100-E, DX 460 MX, DX 351 MX, DX36, DX 2

See **X-EKB, X-ECH fastener program** in the next pages and **Tools and equipment chapter** for more details.

Approvals

UL (USA): X-EKB MX, X-ECH / FR_U37

CSTB (France): X-EKB_U 37, X-ECH_U37

Note: technical data presented in these approvals and design guidelines reflect specific local conditions and may differ from those published in this handbook.

Applications

Examples

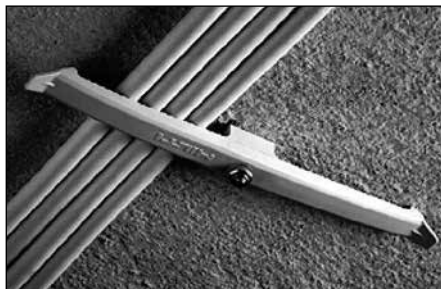

X-EKB for fastening cables



X-ECH for fastening bunched cables

Load data

Fastener capacity

X-EKB: Securing electrical cables to concrete ceilings and walls

Max. capacity (number of cables in one **X-EKB**) at spacing of 50–100 cm

Designation	Number of wires/cables and wire sizes	
	NYM 3 x 1.5 mm² (∅ 8 mm)	NYM 5 x 1.5 mm² (∅ 10 mm)
X-EKB 4 __	4	3
X-EKB 8 __	8	5
X-EKB 16 __	16	10

X-ECH: Securing electrical cable to ceilings and walls

Max. capacity at spacing of 60–80 cm Designation	No. of nails	Number of cables
X-ECH-S __ and X-ECH/FR-S __		max. 15 ∞ NYM 5∞1.5 ² (Δ 10 mm)
X-ECH-M __ and X-ECH/FR-M __		max. 25 ∞ NYM 5∞1.5 ² (Δ 10 mm)
X-ECH-L __ and X-ECH/FR-L __		max. 35 ∞ NYM 5∞1.5 ² (Δ 10 mm)
X-ECH-15 MX and X-ECH-B	1 or 2	max. 15 ∞ NYM 3∞1.5 ² (Δ 10 mm)
X-ECH-30 MX and X-ECH-B	1 or 2	max. 30 ∞ NYM 3∞1.5 ² (Δ 10 mm)

Conditions:

- For concrete C12/15 to C45/55 ($f_{cc} = 15$ to 55 N/mm²)
- All visible placing failures have to be replaced
- Damaged X-ECH have to be replaced

Application requirements

Thickness of base material

Concrete	
X-U:	$h_{min} = 80$ mm
X-GHP, X-GN:	$h_{min} = 60$ mm

Steel
$t_{II} \geq 4$ mm

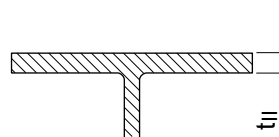

Thickness of fastened material

Fasteners recommended for cable \varnothing 8 mm and 10 mm

Spacing and edge distances

X-EKB:	approximately 50–100 cm	(Adjust as necessary to control cable sag)
X-ECH:	approximately 60– 80 cm	(Adjust as necessary to limit sagging)

Corrosion information

These zinc-coated fasteners are not suitable for long-term service outdoors or in otherwise corrosive environments.

For further detailed information on corrosion see relevant chapter in **Direct Fastening Principles and Technique** section.



Fastener program

Fastener with pre-mounted DX-nail: Technical information

Fastener Designation	Shank Ø d _s [mm]	Shank length L _s [mm]	Tools
① X-EKB8 U 37	4.0	37	DX460-F8, DX351-F8, DX36, DX 2
② X-EKB16 U 37	4.0	37	DX460-F8, DX351-F8, DX36, DX 2
⑤ X-ECH-S U 37	4.0	37	DX460-F8, DX351-F8, DX36, DX 2
⑥ X-ECH-M U 37	4.0	37	DX460-F8, DX351-F8, DX36, DX 2
⑦ X-ECH-L U 37	4.0	37	DX460-F8, DX351-F8, DX36, DX 2
① X-EKB4-FR U 37	4.0	37	DX460-F8, DX351-F8, DX36, DX 2
① X-EKB8-FR U 37	4.0	37	DX460-F8, DX351-F8, DX36, DX 2
② X-EKB16-FR U 37	4.0	37	DX460-F8, DX351-F8, DX36, DX 2
⑤ X-ECH/FR-S U 37	4.0	37	DX460-F8, DX351-F8, DX36, DX 2
⑥ X-ECH/FR-M U 37	4.0	37	DX460-F8, DX351-F8, DX36, DX 2
⑦ X-ECH/FR-L U 37	4.0	37	DX460-F8, DX351-F8, DX36, DX 2

- ③, ④ All nail shanks: carbon steel, HRC 58, galvanized 2–20 µm
Sleeve/thimble: carbon steel, not hardened, galvanized 5–13 µm

①–④ See Product data in previous pages

Fastener with pre-mounted DX-nail: Order information

Designation	Item no.	Plastic material
X-EKB 4-FR U37	361581	Polyamide ²⁾
X-EKB 8 U37	386231	Polyamide ¹⁾
X-EKB 8-FR U37	386233	Polyamide ²⁾
X-EKB 16 U37	386232	Polyamide ¹⁾
X-EKB 16-FR U37	386234	Polyamide ²⁾
X-ECH-S U37	386235	Polyamide ¹⁾
X-ECH-M U37	386236	Polyamide ¹⁾
X-ECH-L U37	386237	Polyamide ¹⁾
X-ECH/FR-S U37	386238	Polyamide ²⁾
X-ECH/FR-M U37	386239	Polyamide ²⁾
X-ECH/FR-L U37	386240	Polyamide ²⁾

¹⁾ halogen and silicon free, light grey RAL 7035

²⁾ halogen and silicon free, flame retardant, stone grey RAL 7030

Fastener without pre-mounted nail: Technical information

Base material	Cable holder		Nail			
	Designation	Technology	Designation	Shank Ø d _s [mm]	Shank length L _s [mm]	L [mm]
Concrete		GX	X-GN 27 MX	3.0	27	28.9
Concrete	X-EKB (FR) 4 MX	GX	X-GHP 20 MX	3.0	20	21.8
Concrete	X-EKB (FR) 8 MX	GX	X-GHP 24 MX	3.0	24	25.8
Concrete	X-EKB (FR) 16 MX	DX	X-U 22 MX	4.0	22	24.4
Concrete	X-ECH-15 MX*	DX	X-U 27 MX	4.0	27	29.4
Steel	X-ECH-30 MX*	GX	X-EGN 14 MX	3.0	14	15.8
Steel		DX	X-U 16 MX	4.0	16	18.4

* To be used with GX Technology ONLY

Fastener without pre-mounted nail: Order information

Fastener	Plastic material	Designation	Item no.
Electrical Cable Holder	Polyamide ¹⁾	X-EKB 4 MX	285712
	Polyamide ¹⁾	X-EKB 8 MX	285713
	Polyamide ¹⁾	X-EKB 16 MX	285714
	Polyamide ²⁾	X-EKB FR 4 MX	285715
	Polyamide ²⁾	X-EKB FR 8 MX	285716
	Polyamide ²⁾	X-EKB FR 16 MX	285717
	Polyamide ¹⁾	X-ECH-15 MX	2018247
	Polyamide ¹⁾	X-ECH-30 MX	2018248
	Polyamide ¹⁾	X-ECH-15/B MX	2018729 (kit)
	Polyamide ¹⁾	X-ECH-30/B MX	2018891 (kit)
GX Nails		X-EGN 14 MX	338872
		X-GHP 20 MX	285890
		X-GHP 24 MX	438945
		X-GN 27 MX	340229
DX Nails		X-U 16 MX	237344
		X-U 22 MX	237346
		X-U 27 MX	237347

¹⁾ halogen and silicon free, light grey RAL 7035

²⁾ halogen and silicon free, flame retardant, stone grey RAL 7030

System recommendation

DX tools:	Steel:	6.8/11M red cartridge
	Concrete:	6.8/11M yellow cartridge on green/fresh and standard concrete 6.8/11M red cartridge on precast, old and hard concrete
	Masonry:	6.8/11M yellow or green cartridge, green for MX Fastener

GX 120-ME tool: **Gas can GC 20. GC21 and GC22**

GX 100-E tool: **Gas can GC 11 (GC 12 in USA)**

Tool energy adjustment by setting tests on site.

Fastening quality assurance

X-EKB fastening quality

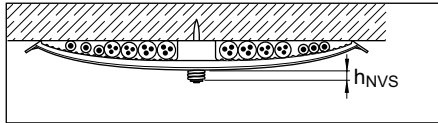

$h_{NVS} = 7 \pm 2 \text{ mm}$

X-ECH fastening quality

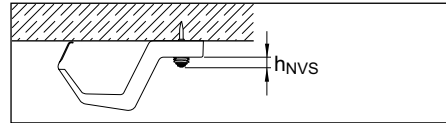

$h_{NVS} = 7 \pm 2 \text{ mm}$

X-FB (X-DFB / X-EMTC) Electrical Conduit Fasteners

Product data

Dimensions

X-FB / X-EMTC

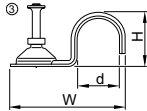

X-DFB

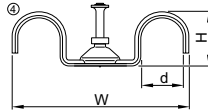

X-FB MX (X-BX/X-EMTC)

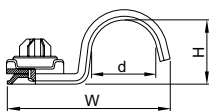

X-GHP 20/24

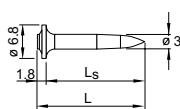

X-GN 27

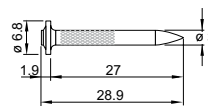

X-EGN 14

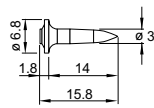

X-U 16/22/27

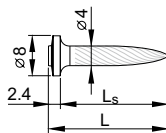

X-C 27

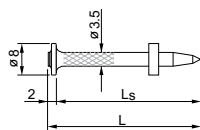

General information

Material specifications

See fastener selection for more details.

Recommended fastening tools

GX 120-ME, GX 100-E, DX 351-MX,
DX 460-MX, DX 351-F8, DX 460-F8,
DX-E 72

See **X-FB (X-DFB/X-EMTC) fastener program** in the next pages and **Tools and equipment chapter** for more details.

Applications

Example

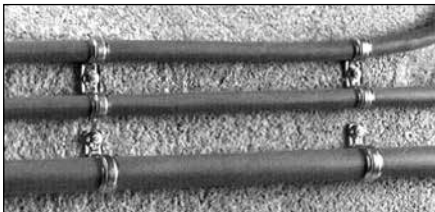

X-FB for rigid conduits

Load data

Recommended loads

Fastener	Concrete N_{rec} [kN]	Sandlime stone N_{rec} [kN]	Steel N_{rec} [kN]
X-FB / X-DFB (pre-mounted)	0.06	0.06	–
X-FB MX with X-U or X-C ($L_s = 22$ or 27 mm)	0.06	0.06	–
X-FB MX with X-U 16 MX	–	–	0.06
X-FB MX with X-GHP ($L_s = 20$ or 24 mm)	0.02	–	–
X-FB MX with X-GN 27	–	0.06	–
X-FB MX with X-EGN 14 or X-U	–	–	0.06

Application requirements

Thickness of base material

Concrete

X-U, X-C: $h_{min} = 80$ mm

X-GHP, X-GN: $h_{min} = 60$ mm

Steel

$t_{II} \geq 4$ mm

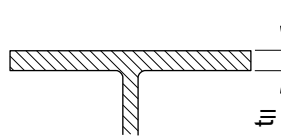

Thickness of fastened material

X-FB (X-BX, X-EMTC) To fasten conduits, pipes and tubes of $\varnothing 8$ mm to 50 mm

Spacing and edge distances

Space fastenings as needed to control sag and maintain alignment.

Corrosion information

These zinc-coated fasteners are not suitable for long-term service outdoors or in otherwise corrosive environments.

For further detailed information on corrosion see relevant chapter in **Direct Fastening Principles and Technique** section.

Application limits

Gas nails $f_{cc} \leq 30$ N/mm²

X-U and X-C $f_{cc} \leq 45$ N/mm²

Fastener program
Technical information

With pre-mounted nail		Without pre-mounted nail			
Designation	Designation	d [mm]	W [mm]	H [mm]	
③	X-FB 5 MX	5		7	
③	X-FB 6 MX	6		8	
③	X-FB 7 MX	7		9	
③	X-FB 8-C27	X-FB 8 MX	8	31	10
③	X-EMTC $\frac{3}{8}$"-C27/-U22	X-BX $\frac{3}{8}$" MX	10 ($\frac{3}{8}$ "	33	12
③	X-FB 11-C27	X-FB 11 MX	11	34	13
③	X-EMTC $\frac{1}{2}$"-C27/-U22		13 ($\frac{1}{2}$ "		
③	X-FB 13-C27	X-EMTC $\frac{1}{2}$" MX	13 ($\frac{1}{2}$ "	42	15
③	X-FB 16-C27	X-FB 16 MX	16	44	18
③	X-FB 18-C27		18	46	20
③	X-EMTC $\frac{3}{4}$"-C27/-U22	X-EMTC $\frac{3}{4}$" MX	19 ($\frac{3}{4}$ "	47	21
③	X-FB 20-C27	X-FB 20 MX	20	48	22
③	X-FB 22-C27	X-FB 22 MX	22	50	24
③	X-FB 24-C27		24	52	26
③	X-FB 25-C27	X-FB 25 MX, X-EMTC 1" MX	25 (1")	53	27
③	X-EMTC 1"-C27/-U22		25 (1")		
③	X-FB 28-C27	X-FB 28 MX	28	56	30
③	X-FB 32-C27	X-FB 32 MX	32	58	34
③	X-FB 35-C27		35	64	37
③	X-FB 40-C27	X-FB 40 MX	40	69	42
③	X-FB 50-C27		50	77	52
④	X-DFB 5 MX	5	47	7	
④	X-DFB 6 MX	6	50	8	
④	X-DFB 7 MX	7	52	9	
④	X-DFB 8-C27	X-DFB 8 MX	8		9.5
④	X-DFB 11-C27	X-DFB 11 MX	11		12.5
④	X-DFB 16-C27	X-DFB 16 MX	16	66	15
④	X-DFB 18-C27		18	70	18
④	X-DFB 20-C27	X-DFB 20 MX	20	75	20
④	X-DFB 22-C27	X-DFB 22 MX	22	79	22
④	X-DFB 24-C27	X-DFB 25 MX	24	83	24
④	X-DFB 25-C27		25		
④	X-DFB 28-C27	X-DFB 28 MX	28	91	28
④	X-DFB 35-C27		35	106	30
④	X-DFB 40-C27		40	116	37
	X-U nail	Nail shank: Carbon steel, HRC 58		Zinc coating: 5–20 µm	
	X-C nail	Nail shank: Carbon steel, HRC 56.5		Zinc coating: 5–20 µm	
	X-GHP nail	Nail shank: Carbon steel, HRC 58		Zinc coating: 2–10 µm	
	X-GN nail	Nail shank: Carbon steel, HRC 53.5		Zinc coating: 5–13 µm	

Material specification:

① + ④ Galvanized steel sheet, $f_u = 270\text{--}420\text{ N/mm}^2$, 10–20 μm zinc coating

Tools:

DX 351-F8, DX 460-F8, DX-E 72 for all **X-FB/DFB/EMTC** with pre-mounted nails
and

GX 120-ME, GX 100-E, DX 351-MX, DX 460-MX for **X-FB/DFB/EMTC __MX**

X-FB/DFB:

DFastening of electrical conduits and light-duty water or heating pipes on concrete

Capacity:	Nail choice:	
conduit $\varnothing \leq d$	Gas Nails	for $f_{cc} \leq 30\text{ N/mm}^2$
conduit $\varnothing \leq d$	X-U and X-C	for $f_{cc} \leq 45\text{ N/mm}^2$

System recommendation

DX tools: Steel: **6.8/11M yellow or red cartridge**
 Concrete: **6.8/11M yellow cartridge** on green/fresh and standard concrete
 6.8/11M red cartridge on precast, old and hard concrete
 Masonry: **6.8/11M green cartridge**

GX 120 tool: **Gas can GC 20. GC1 and GC22**

GX 100 tool: **Gas can GC 11 (GC 12 in USA)**

Tool energy adjustment by setting tests on site.

Fastening quality assurance

Nailhead not protruding

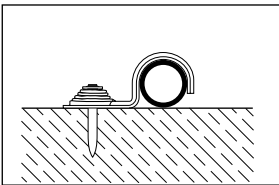

X-ECT MX Electrical Cable Tie, X-UCT MX Electrical Cable Tie, X-EKS MX Conduit Clip Fastener

Product data

Dimensions

X-ECT MX



X-UCT MX



X-EKS MX

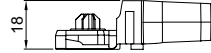

X-ECT 40 MX

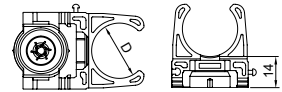
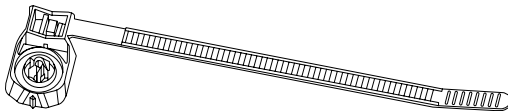

X-EKSC MX

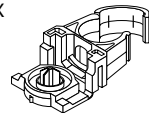

X-GHP 20/24

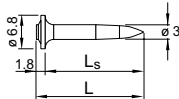

X-GN 27

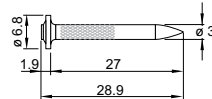

X-EGN 14

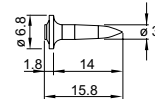

X-U 16/22/27

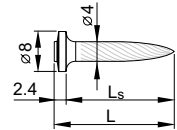

General information

Material specifications

X-ECT and X-EKS:

Polyamide (halogen and silicon free), light grey RAL 7035 and PBT (silicon free, flame retardant), stone grey RAL 7030

X-UCT MX:

HDPE (halogen and silicon free), light grey RAL 7035

Nails:

Carbon Steel HRC 58
HRC 53.5
Zinc coating 2–13 µm
5–20 µm

X-GHP 20/24, X-EGN 14, X-U
X-GN 27

X-GHP 20/24, X-GN 27, X-EGN 14
X-U

Recommended fastening tools

GX 120-ME, GX 100-E, DX 460-MX, DX 351-MX

See **X-ECT MX, X-UCT MX and X-EKS MX fastener program** in the next pages and **Tools and equipment** chapter for more details.

Approvals

CSTB (France)
UL (USA)

X-ECT MX, X-EKS MX, X-EKSC MX (all with X-U22 MX nail)
X-ECT MX

Applications

Examples



Flexible or rigid cable conduits with cable ties



Rigid conduits



Cable conduits or light duty pipes

Load data

Recommended loads

Fastener	Service load ¹⁾ [kN]
X-ECT MX / X-ECT 40 MX, X-UCT MX	0.04
X-EKS MX	0.02

¹⁾ The recommended service load is determined by the serviceability of the plastic part.

Application requirements

Thickness of base material

Concrete

X-U: $h_{\min} = 80 \text{ mm}$

X-GHP, X-GN: $h_{\min} = 60 \text{ mm}$

Steel

$t_{II} \geq 4 \text{ mm}$

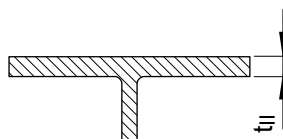

Spacing

50–100 cm along the cable tie. Adjust spacing as needed to achieve stability of cable tie

Corrosion information

These zinc-coated fasteners are not suitable for long-term service outdoors or in otherwise corrosive environments.

For further detailed information on corrosion see relevant chapter in **Direct Fastening Principles and Technique** section.

Fastener selection

 Suitable cables with **X-ECT MX, X-ECT 40 MX** and **X-UCT MX** fastener

Cable type	Cable measure [Ø mm]	No. of cables
NYM 3x1.5	8	14
NYM 5x1.5	10	10

 Suitable conduits with **X-EKS / X-EKSC MX** fastener

Conduit type	Conduit size [mm]	No. of conduits
Plastic conduit	16–40	1

Fastener program

Base material	Nail		Shank Ø *) d _s [mm]	Shank length*) L _s [mm]	L [mm]
	Designation	Technology			
Concrete	X-U 22 MX	DX	4.0	22	–
Concrete	X-U 27 MX	DX	4.0	27	–
Steel	X-U 16 MX	DX	4.0	16	–
Concrete	X-GHP 20 MX	GX	3.0	20	21.8
Concrete	X-GHP 24 MX	GX	3.0	24	25.8
Concrete or masonry	X-GN 27 MX	GX	3.0	27	28.9
Steel	X-EGN 14 MX	GX	3.0	14	15.8

*) Standard chank diameters and shank lengths. Other combinations available on special order.

Tools:

DX technology: DX 460-MX, DX 351-MX (for X-ECT MX and X-EKS MX)

GX technology: GX 120-ME, GX 100-E (for X-ECT MX, X-EKS MX and X-UCT MX)

X-EKS

Item no.	Designation
285719	X-EKS 16 MX
2105391	X-EKS 19 MX
285720	X-EKS 20 MX
285721	X-EKS 25 MX
285722	X-EKS 32 MX
285723	X-EKS 40 MX

X-ECT

Item no.	Designation
285709	X-ECT MX
285710	X-ECT UV MX
285711	X-ECT FR MX
432947	X-ECT 40 MX

X-UCT MX

Item no.	Designation
2095183	X-UCT MX

GX nails

Item no.	Designation
338872	X-EGN 14 MX
340229	X-GHP 20 MX
438945	X-GHP 24 MX
34541	X-GN 27 MX

DX Nails

Item no.	Designation
237344	X-U 16 MX
237346	X-U 22 MX
237347	X-U 27 MX

X-EKSC

Item no.	Designation
274083	X-EKSC 16 MX
274086	X-EKSC 20 MX
274087	X-EKSC 25 MX
386469	X-EKSC 32 MX
386470	X-EKSC 40 MX

System recommendation

- DX tools: Steel: **6.8/11M yellow or red cartridge**
 Concrete: **6.8/11M yellow cartridge** on green/fresh and standard concrete
6.8/11M red cartridge on precast, old and hard concrete
 Masonry: **6.8/11M green cartridge**

GX 120 tool: **Gas can GC 20, GC21 and GC22**

GX 100 tool: **Gas can GC 11** (GC 12 in USA)

Tool energy adjustment by setting tests on site.

X-ET for Fastening Plastic Electrical Cable Trays and Junction Boxes

Product data

Dimensions

X-ET UK-H27

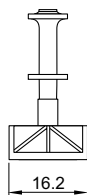
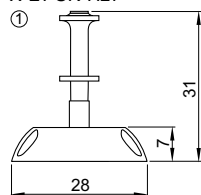

UK-H27

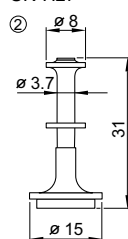

X-ET MX

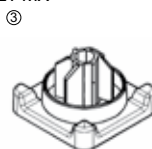

w x l x h = 16.5 x 16.5 x 12 mm

X-GHP 20/24

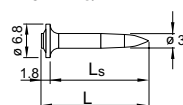

X-GN 27

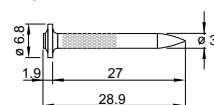

X-EGN 14

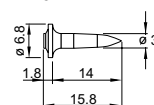

X-U 16/22/27

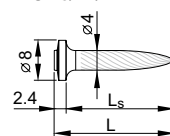

General information

Material specifications

X-ET	Polyethylene
X-ET MX	Polyamide (halogen and silicon free), light grey RAL 7035 and PBT (silicon-free, flame retardant), stone grey RAL 7030

Nails:

Carbon steel	HRC 58	X-GHP 20/24, X-EGN 14
	HRC 53.5	X-GN 27
	HRC 58	X-U 16 / 22/ 27
Zink-coating	2–13 μm	X-GHP 20, X-EGN 14, X-GN 27
	5–20 μm	X-U

Recommended fastening tools

DX 460-MX, DX 351-MX, GX 120-ME, GX 100-E

See **X-ET fastener program** in the next pages and **Tools and equipment** chapter for more details.

Applications

Examples



Cable trunking

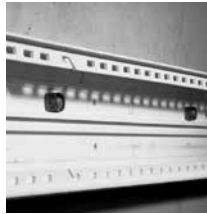

Cable trunking



Junction boxes



Conduits & pipes with metal or textile band

Load data

Recommended load

Fastener	Service load ¹⁾ [kN]
X-ET MX	0.1

¹⁾ The recommended service load is controlled by serviceability of the plastic part.

Application requirements

Thickness of base material

Concrete

X-U: $h_{\min} = 80 \text{ mm}$

X-GHP, X-GN: $h_{\min} = 60 \text{ mm}$

Steel

$t_{\parallel} \geq 4 \text{ mm}$

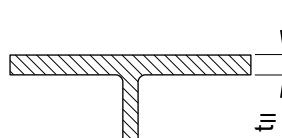

Corrosion information

These zinc-coated fasteners are not suitable for long-term service outdoors or in otherwise corrosive environments.

For further detailed information on corrosion see relevant chapter in **Direct Fastening Principles and Technique** section.

Fastener program

No.	Techno-logy	Base material	Fastener		Shank Ø d _s [mm]	Shank length L _s [mm]	Tools
			Fastener	Designation			
①	DX	Concrete /steel	X-ET	X-ET UK-H27	3.7	27	DX 460-F8
③	DX	Concrete /steel	X-ET MX	X-U 22/27 MX	4.0	22/27	DX 460-MX, DX 351-MX
③	DX	Steel	X-ET MX	X-U 16 MX	4.0	16	DX 460-MX, DX 351-MX
③	GAS	Concrete	X-ET MX	X-GHP 20	3.0	20	GX 120-ME
③	GAS	Concrete	X-ET MX	X-GN 27	3.0	27	GX 120-ME
③	GAS	Steel	X-ET MX	X-EGN 14	3.0	14	GX 120-ME
③	GAS	Sandlime masonry	X-ET MX	All GX nails	3.0	see above	GX 120-ME

Order information

Fastener	Item no.	Designation
X-ET	251705	X-ET UK-H27
	285718	X-ET MX
DX Nails	237344	X-U 16 MX
	237346	X-U 22 MX
	237347	X-U 27 MX
GX nails	338872	X-EGN 14 MX
	285890	X-GHP 20 MX
	340229	X-GN 27 MX

Conditions for use:

- No fastenings on ribs
- Underside of trunking must be smooth
- X-ET MX only in pre-drilled holes

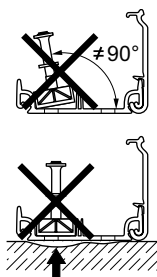

Trunking dimensions:

t₁ ≤ 2 mm PVC

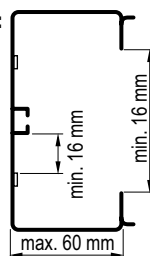

System recommendation

DX tools: Steel: **6.8/11M yellow or red cartridge**
 Concrete: **6.8/11M yellow cartridge** on green/fresh and standard concrete
 6.8/11M red cartridge on precast, old and hard concrete
 Masonry: **6.8/11M green cartridge**

GX 120-ME tool: **Gas can GC 20, GC 21 and GC22**

GX 100-E tool: **Gas can GC 11** (GC 12 in USA)

Tool energy adjustment by setting tests on site.



GX-WF Wood Framing Nails

Product data

Dimensions

GX-WF smooth shank nails
(example with D-head)



Available head shapes



d_n = Nom. Nail Diameter
 d_h = Nom. Head Diameter
 l_g = Length of Profile
 l_n = Nom. Nail Length
 l_p = Nom. Point Length
 t_{pen} = Pointside Penetration Depth
 t = Fastening Height

GX-WF profiled shank nails
(example with round head)



Other dimensions

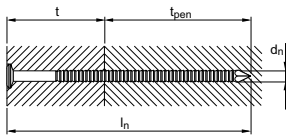
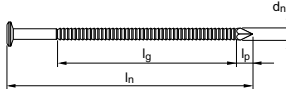

General information

Material specifications

Carbon Steel or Stainless Steel with a minimum tensile strength of 600 N/mm²

Recommended fastening tool

GX 90 WF

Approvals

CE Marking according to EN 14592 (EU)
 BRANZ Appraisal No. 780 (2012) (NZ)

Applications

Examples

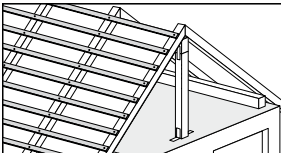

Battens

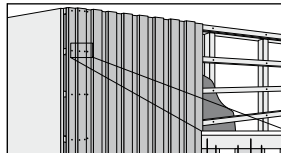

Cladding

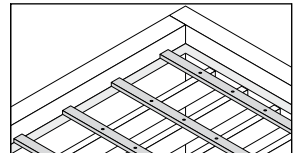

Flat roof

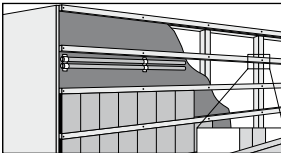

Sub-construction

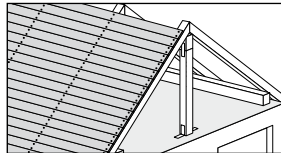

Roof paneling

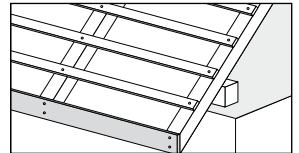

Roof trim

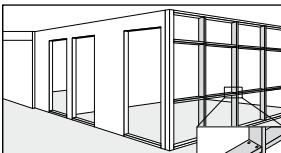

Wall framing

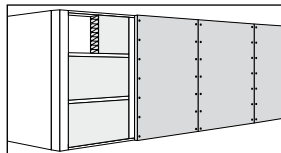

Wall sheeting

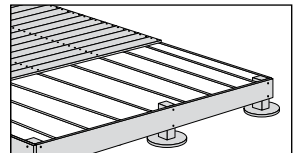

Wood decking

Corrosion information

Suitable Nail Materials depending on Service Class

Corrosion Protection Requirements	EN 1995-1-1 Service Classes related to ISO 2081 ¹⁾		
	1	2	3
Typical average moisture content of the wood specimens	≤ 12%	≤ 20%	> 20%
Designation on package / label			
Requirements for Nails with d ≤ 4 mm	No coating	Fe/Zn 12c	Fe/Zn 25c ²⁾
Suitable GX-WF Materials	All	Galvanized, Hot Dip Galvanized, Stainless	Hot Dip Galvanized, Stainless

1 In particularly corrosive environments, thicker Hot Dip Galvanization or Stainless Steel shall be considered
 2 For Hot Dip Galvanized nails typically Fe/Zn 25c is substituted by Z350 according to EN 10147

Note: Certain wood treatments and species, like Oak, Douglas-fir or similar, require stainless steel nails due to the acidity of the wood, typically independent of the Service Class.

Load data

Characteristic yield moment $M_{y,k}$

Nail Type	Available coating / material				Nail Diameter d_n [mm]	Minimum Tensile Strength f_u [N/mm ²]	Characteristic Yield Moment $M_{ny,k}$ ^{1,2} [Nmm]
	Bright	Galv	HDG	A2 & A4			
Smooth Nails							
GX-WF [l_n] x 2.8 D 34	●	●	●		2.8	600	2617
GX-WF [l_n] x 3.1 D 34	●	●	●		3.1	600	3410
Profiled Nails							
GX-WF [l_n] x 2.8 RD 34	●	●			2.8	600	2320
GXWF [l_n] x 2.8 RD 34 2000		●			2.8	600	2743
GX-WF [l_n] x 3.1 RD 34	●	●			3.1	600	3320
GX-WF [l_n] x 2.8 RD 34			●		2.8	600	2130
GX-WF [l_n] x 3.1 RD 34			●		3.1	600	2820
GX-WF [l_n] x 2.8 R/RD 34				●	2.8	600	1960
GX-WF [l_n] x 3.1 RD 34				●	3.1	600	2830

1 Values for smooth nails calculated per EN 1995-1-1 (Eurocode 5), section 8.3.1.1.

2 Values for profiled nails based on testing in accordance with EN 409 and EN 14592

Characteristic Pull-out and Head Pull-through Resistance for wood density of 350 kg/m³

Nail Type	Nail diameter d_n [mm]	Head diameter for calculations d_h [mm]	Characteristic withdrawal parameter ¹ $f_{ax,k}$ [N/mm²]	Char. Head pull-through parameter ² $f_{head,k}$ [N/mm²]
Smooth Nails³				
GX-WF [I _n] x 2.8 D 34 (independent of type of corrosion protection)	2.8	7	2.45	8.57
GX-WF [I _n] x 3.1 D 34 (independent of type of corrosion protection)	3.1	7.2	2.45	8.57
Profiled Nails⁴				
GX-WF [I _n] x 2.8 RD 34	2.8	7	7.69	12.54
GX-WF [I _n] x 3.1 RD 34	3.1	7.2	6.77	13.91
GX-WF [I _n] x 2.8 RD 34 galv	2.8	7	7.38	12.54
GX-WF [I _n] x 2.8 RD 34 2000 galv	2.8	7	5.37	14.75
GX-WF [I _n] x 3.1 RD 34 galv	3.1	7.2	6.32	13.91
GX-WF [I _n] x 2.8 RD 34 HDG	2.8	7	8.83	12.54
GX-WF [I _n] x 3.1 RD 34 HDG	3.1	7.2	10.58	13.91
GX-WF [I _n] x 2.8 RD 34 A2 & A4	2.8	7	8.95	12.54
GX-WF [I _n] x 3.1 RD 34 A2 & A4	3.1	7.2	6.26	13.91
GX-WF [I _n] x 2.8 R 34 A2 & A4	2.8	6.4	8.95	15.73

1 Values are valid for penetration depths of 12d (smooth nails) or 8d (profiled nails) respectively. Reduction may factors apply acc. to EN 1995-1-1, section 8.3.2 for smaller penetration depths or for nails installed into wood near the fibre saturation point. The minimum point side penetration depth is 8d (smooth nails) and 6d (profiled nails) respectively. See also section "Application limits"

2 For D-Head nails, the head pull-through parameter $f_{head,k}$ was determined based on testing and calculation using the larger diameter d_h as shown in the Product Data Section. Therefore this value is also given in this table to calculate the correct head pull-through resistance

3 Values for smooth nails are calculated per EN 1995-1-1 section 8.3.2 (6)

4 Values for $f_{ax,k}$ and $f_{head,k}$ for profiled nails based on Initial Type Testing in accordance with EN 14592

Design data in accordance with EN 1995-1-1 (Eurocode 5), Section 8

Design Conditions for Wood to Wood connections:

- Correct installation according to this document, Hilti's printed installation instructions and applicable regulations
- Appropriate nail was selected for the relevant Service Class
- Connection must consist of at least 2 nails



Shear Capacity:

The shear capacity and combined loading capacity has to be calculated according to EN 1995-1-1 or other applicable regulations. The shear capacity depends on the type of connection, the bearing strength of the wood, the slenderness of the nails and the withdrawal strength of the nails. Minimum point side penetration depths are given in the section “Fastener Selection”. Other geometrical connection parameters shall comply with EN-1995-1-1 (EuroCode 5) or other applicable regulations.

Explanation of the failure modes associated with the design parameters presented on this document



Yield Moment $M_{y,k}$

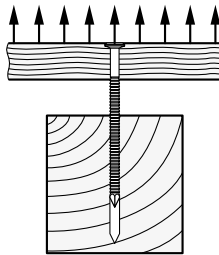

Pull-out $f_{ax,k}$

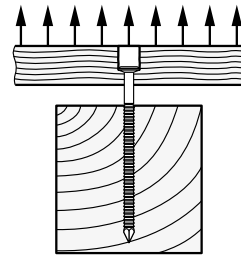

Head pull-through $f_{head,k}$

Calculation example

This calculation should illustrate the characteristic capacity of a common nail type in tension. For a full design, the provisions in EN 1995-1-1 shall be followed using the technical data in this document.

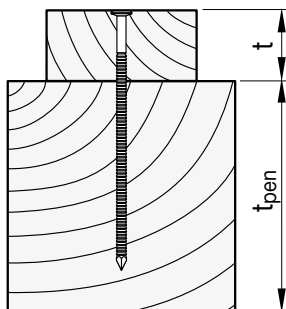

Example:

Characteristic withdrawal capacity for a galvanized profiled nail **GX-WF 90 x 3.1 RD 34 Galv**

Input data:

t = 20 mm; t_{pen} = 70 mm; k_p = 350 kg/m³

⇒ f_{ax,k} = 6.32 N/mm² and f_{head, k} = 13.91 N/mm² (see Characteristic Pull out and Pull-through Resistance table)

GX-WF 90 x 3.1 RD 34 Galv

l_g = 73.2 mm; l_p = 4.8 mm; d_n = 3.1 mm; d_h = 7.2 mm (see Galvanized Nails, Service Class 1&2 table)

⇒ l_g + l_p = 78 mm > t_{pen} ⇒ → Embedded part is fully threaded (except tip)

⇒ Only threaded part transfers axial loads: = t_{pen} - l_p = 70 mm - 4.8 mm = 65.2 mm

Calculations:

Pull-out capacity: **f_{ax,k} = 6.32 x 3.1 x (70-4.8) = 1277 [N]**

Head pull-through capacity: **f_{head,k} = 13.91 x 7.2² = 721 [N]**

Char. withdrawal capacity:

F_{ax,Rk} = min {f_{ax,k} x d_n x (t_{pen}-l_p); f_{head,k} x d_h²} = 721 N

⇒ **Head pull-through governs**

Note: Nail Tensile strength doesn't govern for GX-WF nails

Results:

To calculate the **design withdrawal load F_{ax,Rd}**, a safety factor γ_M (= 1.3 for connections) and a modification factor k_{mod} for load duration, wood type and moisture, apply per Eurocode 5

⇒ Example: solid timber, Service Class 2, permanent loading ⇒ γ_M = 1.3; k_{mod} = 0.6

⇒ **F_{ax,Rd} = F_{ax,Rk} x k_{mod} / γ_M = 721 N x 0.6 / 1.3 = 333 N or 34 kg**

Application requirements

Minimum point side penetration depth

(for nails in tension please consider Characteristic Pull out and Pull-through Resistance table, footnote 1):

- 8 x nail diameter d_n for smooth nails
- 6 x nail diameter d_n for profiled nails

Spacing and edge distance:

Geometrical limitations like spacing and edge distance shall be in compliance with EN 1995-1-1 or other applicable regulations

Fastener Selection and system recommendation

The information in this section complies with EN 1995-1-1 (Eurocode 5) and EN 14592. Item numbers shown in the following tables are for nails only and do not include gas cans.



Where do I use profiled or smooth nails?

In accordance with EN 1995-1-1 the following general rules apply. For non-structural applications, like e.g. battens, other local regulations may apply:

- Profiled nails shall be used for permanent or long-term withdrawal loads > 6 months (see table 2.1 of EN 1995-1-1)
- Smooth nails can only be used for short to medium term withdrawal loads < 6 months (e.g. wind) or for shear loads only

Available head shapes

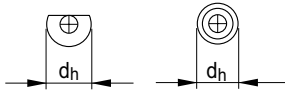

Other dimensions

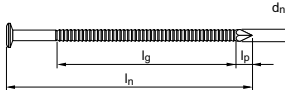

d_n = Nom. Nail Diameter
 d_h = Nom. Head Diameter
 l_g = Length of Profile
 l_n = Nom. Nail Length
 l_p = Nom. Point Length
 t_{pen} = Pointside Penetration Depth
 t = Fastening Height

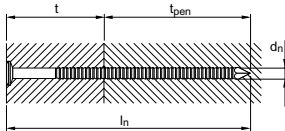

Bright Steel Nails Service Class 1

Item no.	Designation GX-WF (length, l_n) x (dia., d_n)	Head dia., d_h [mm]	Max. fastening height, t [mm]	Min. Length of profile, l_g [mm]	Max. Point length, l_p [mm]
2083658	GX-WF 51x2.8 D 34	7	28	n/a	4.3
2083659	GX-WF 63x2.8 D 34	7	40	n/a	4.3
2083750	GX-WF 70x2.8 D 34	7	47	n/a	4.3
2083751	GX-WF 75x2.8 D 34	7	52	n/a	4.3
2083952	GX-WF 80x2.8 D 34	7	57	n/a	4.3
2083753	GX-WF 80x3.1 D 34	7.2	55	n/a	4.8
2083754	GX-WF 90x3.1 D 34	7.2	65	n/a	4.8
2054064	GX-WF 90x3.1 D 34 2000	7.2	65	n/a	5.4
2083755	GX-WF 51x2.8 RD 34	7	34	34	4.3
2083756	GX-WF 63x2.8 RD 34	7	46	46	4.3
2083757	GX-WF 70x2.8 RD 34	7	53	53	4.3
2083758	GX-WF 75x2.8 RD 34	7	58	58	4.3
2083759	GX-WF 80x2.8 RD 34	7	63	63	4.3
2083760	GX-WF 70x3.1 RD 34	7.2	51	53	4.8
2083761	GX-WF 75x3.1 RD 34	7.2	56	58	4.8
2083762	GX-WF 80x3.1 RD 34	7.2	61	63	4.8
2083763	GX-WF 90x3.1 RD 34	7.2	71	73	4.8

Galvanized Nails, Service Class 1 & 2

Item no.	Designation GX-WF (length, l _n) x (dia., d _n)	Head dia., d _h [mm]	Max. fastening height, t [mm]	Min. Length of profile, l _g [mm]	Max. Point length, l _p [mm]
2083764	GX-WF 51x2.8 D 34 Galv	7	28	n/a	4.3
2083765	GX-WF 63x2.8 D 34 Galv	7	40	n/a	4.3
2083766	GX-WF 70x2.8 D 34 Galv	7	47	n/a	4.3
2083767	GX-WF 75x2.8 D 34 Galv	7	52	n/a	4.3
2083768	GX-WF 80x2.8 D 34 Galv	7	57	n/a	4.3
2083769	GX-WF 75x3.1 D 34 Galv	7.2	50	n/a	4.8
2083770	GX-WF 80x3.1 D 34 Galv	7.2	55	n/a	4.8
2083771	GX-WF 90x3.1 D 34 Galv	7.2	65	n/a	4.8
2054068	GX-WF 90x3.1 D 34 2000 Galv	7.2	65	n/a	5.4
2083772	GX-WF 51x2.8 RD 34 Galv	7	34	34	4.3
2054069	GX-WF 51x2.8 RD 34 3000 Galv	7	34	26	4.9
2083773	GX-WF 63x2.8 RD 34 Galv	7	46	46	4.3
2054270	GX-WF 63x2.8 RD 34 3000 Galv	7	46	38	4.9
2083774	GX-WF 70x2.8 RD 34 Galv	7	53	53	4.3
2083775	GX-WF 75x2.8 RD 34 Galv	7	58	58	4.3
2083776	GX-WF 80x2.8 RD 34 Galv	7	63	63	4.3
2083777	GX-WF 70x3.1 RD 34 Galv	7.2	51	53	4.8
2083778	GX-WF 75x3.1 RD 34 Galv	7.2	56	58	4.8
2083779	GX-WF 80x3.1 RD 34 Galv	7.2	61	63	4.8
2083780	GX-WF 90x3.1 RD 34 Galv	7.2	71	73	4.8

Hot Dip Galvanized Nails, Service Class 1, 2 & 3

Item no.	Designation	Head	Max. fastening	Min. Length	Max.
	GX-WF (length, l _n) x (dia., d _H)	dia., d _H [mm]	height, t [mm]	of profile, l _g [mm]	Point length, l _p [mm]
2083781	GX-WF 51x2.8 D 34 HDG	7	28	n/a	4.3
2083782	GX-WF 63x2.8 D 34 HDG	7	40	n/a	4.3
2083783	GX-WF 75x2.8 D 34 HDG	7	52	n/a	4.3
2083784	GX-WF 75x3.1 D 34 HDG	7.2	50	n/a	4.8
2083785	GX-WF 80x3.1 D 34 HDG	7.2	55	n/a	4.8
2083786	GX-WF 90x3.1 D 34 HDG	7.2	65	n/a	4.8
2083787	GX-WF 51x2.8 RD 34 HDG	7	34	34	4.3
2083788	GX-WF 63x2.8 RD 34 HDG	7	46	46	4.3
2083789	GX-WF 75x2.8 RD 34 HDG	7	58	58	4.3
2083790	GX-WF 80x2.8 RD 34 HDG	7	63	63	4.3
2083791	GX-WF 63x3.1 RD 34 HDG	7.2	44	46	4.8
2083792	GX-WF 75x3.1 RD 34 HDG	7.2	56	58	4.8
2083793	GX-WF 80x3.1 RD 34 HDG	7.2	61	63	4.8
2083794	GX-WF 90x3.1 RD 34 HDG	7.2	71	73	4.8

Stainless Steel Nails, Service Class 1, 2 & 3

Item no.	Designation	Head	Max. fastening	Min. Length	Max.
	GX-WF (length, l _n) x (dia., d _H)	dia., d _H [mm]	height, t [mm]	of profile, l _g [mm]	Point length, l _p [mm]
2006654	GX-WF 51x2.8 RD 34 A2	7	34	34	4.3
2006655	GX-WF 63x2.8 RD 34 A2	7	46	46	4.3
2006656	GX-WF 80x3.1 RD 34 A2	7.2	61	63	4.8
2006657	GX-WF 55x2.8 R 34 A2	6.4	38	38	4.3
2006658	GX-WF 65x2.8 R 34 A2	6.4	48	48	4.3
2006659	GX-WF 80x2.8 R 34 A2	6.4	63	63	4.3
2006660	GX-WF 51x2.8 RD 34 A4	7	34	34	4.3
2006661	GX-WF 63x2.8 RD 34 A4	7	46	46	4.3
2006662	GX-WF 80x3.1 RD 34 A4	7.2	61	63	4.8
2006663	GX-WF 55x2.8 R 34 A4	6.4	38	38	4.3
2006664	GX-WF 65x2.8 R 34 A4	6.4	48	48	4.3
2006665	GX-WF 80x2.8 R 34 A4	6.4	63	63	4.3

Declarations of performance numbers

DoP Number	EN	Product
Hilti-DX-DoP-101	EN 14592	Hilti wood nail GX-WF [In]x2.8 D 34 bright
Hilti-DX-DoP-102	EN 14592	Hilti wood nail GX-WF [In]x2.8 D 34 galv
Hilti-DX-DoP-103	EN 14592	Hilti wood nail GX-WF [In]x2.8 D 34 HDG
Hilti-DX-DoP-104	EN 14592	Hilti wood nail GX-WF [In]x2.8 RD 34 bright
Hilti-DX-DoP-105	EN 14592	Hilti wood nail GX-WF [In]x2.8 RD 34 galv
Hilti-DX-DoP-106	EN 14592	Hilti wood nail GX-WF [In]x2,8 RD 34 3000 galv
Hilti-DX-DoP-107	EN 14592	Hilti wood nail GX-WF [In]x2.8 RD 34 HDG
Hilti-DX-DoP-108	EN 14592	Hilti wood nail GX-WF [In]x2.8 RD 34 A2
Hilti-DX-DoP-109	EN 14592	Hilti wood nail GX-WF [In]x2.8 RD 34 A4
Hilti-DX-DoP-110	EN 14592	Hilti wood nail GX-WF [In]x2.8 R 34 A2
Hilti-DX-DoP-111	EN 14592	Hilti wood nail GX-WF [In]x2.8 R 34 A4
Hilti-DX-DoP-112	EN 14592	Hilti wood nail GX-WF [In]x3.1 D 34 bright
Hilti-DX-DoP-113	EN 14592	Hilti wood nail GX-WF [In]x3,1 D 34 2000
Hilti-DX-DoP-114	EN 14592	Hilti wood nail GX-WF [In]x3.1 D 34 galv
Hilti-DX-DoP-115	EN 14592	Hilti wood nail GX-WF [In]x3,1 D 34 2000 galv
Hilti-DX-DoP-116	EN 14592	Hilti wood nail GX-WF [In]x3.1 D 34 HDG
Hilti-DX-DoP-117	EN 14592	Hilti wood nail GX-WF [In]x3.1 RD 34 A2
Hilti-DX-DoP-118	EN 14592	Hilti wood nail GX-WF [In]x3.1 RD 34 A4
Hilti-DX-DoP-119	EN 14592	Hilti wood nail GX-WF [In]x3.1 RD 34 bright
Hilti-DX-DoP-120	EN 14592	Hilti wood nail GX-WF [In]x3.1 RD 34 galv
Hilti-DX-DoP-121	EN 14592	Hilti wood nail GX-WF [In]x3.1 RD 34 HDG

Fastening quality assurance

Fastening Inspection

Fastening wood to wood

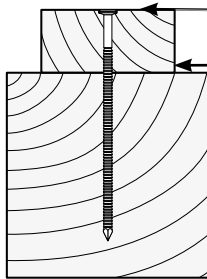

After correct Installation, the nail head should be flush with the wood surface.

The fastened wood member should be fully in contact with the supporting base wood member, if not required differently by the specific design of the connection.

Pre-drilling requirements

Pre-drilling requirements are described in EN 1995-1-1, section 8.3.1.2.

Part 5:

Direct fastening principles and technique

1. Introduction

1.1 Definitions and general terminology

Hilti direct fastening technology is a technique in which specially hardened nails or studs are driven into steel, concrete or masonry by a piston-type tool. Materials suitable for fastening by this method are steel, wood, insulation and some kinds of plastic. Fastener driving power is generated

by a power load (a cartridge containing combustible propellant powder, also known as a “booster”), combustible gas or compressed air. During the driving process, base material is displaced and not removed. In Hilti terminology, **DX** stands for “powder-actuated” and **GX** for “gas-actuated” systems.

1.2 Reasons for using powder- or gas-actuated fastening

The illustrations below show some of the main reasons why many contractors take

advantage of the benefits of powder or gas-actuated fastening.

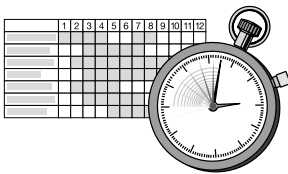

Speed is important.

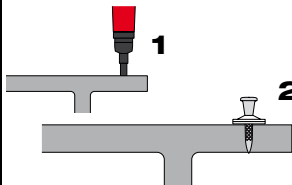

An easy-to-use, uncomplicated fastening system is required.

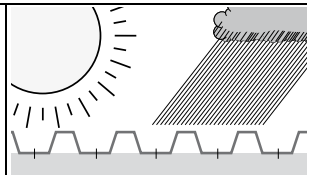

A weather-independent fastening system is required.



Electric power is not available or electric cables would hinder the work.

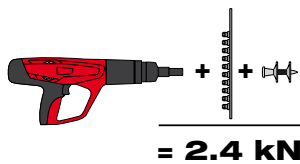

A complete fastening system with assured strength is required.



Drilling is not viable because of noise.

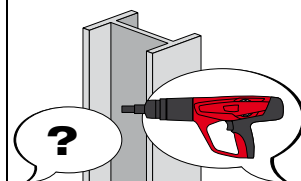

Drilling would be too difficult.

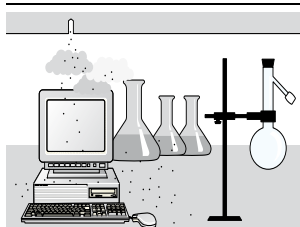

Drilling would cause too much dust.

1.3 Direct fastening applications

Typical applications for powder- or gas-actuated fastening are shown in the illustrations below:

- Fastening thin metal sheets: roof decking wall liners and floor decking
- Fastening thicker steel members: e.g. metal brackets, clips
- Fastening soft materials such as wooden

battens or insulation to steel, concrete or masonry

- Threaded studs for suspended ceilings, installing building services, bar gratings or chequer plate floors
- Connections for composite structures: fastening nailed composite shear connectors

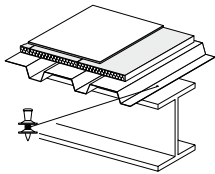

Roof decking

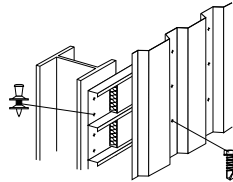

Wall liners

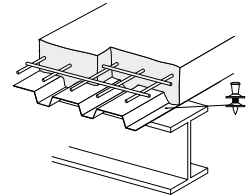

Floor decking

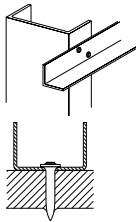

Metal brackets, clips and tracks

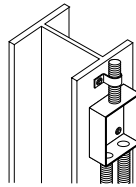

Fixtures for mechanical and electrical installations

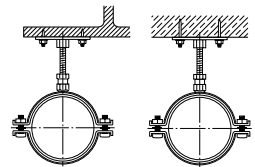

Hangers with threaded connectors

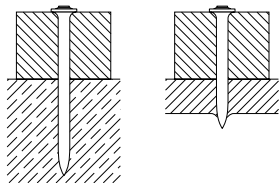

Wooden battens fastened to steel or concrete

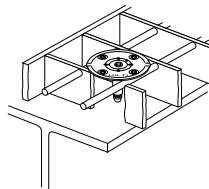

Grating fastenings

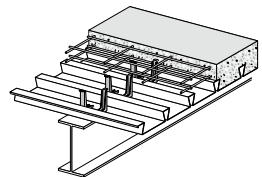

Shear connectors

Hilti direct fastening systems are specially designed for each application and trade.

Key applications and the corresponding fastening systems are shown below.

Roof and floor decking in steel & metal construction



X-ENP-19 L15

DX 76 PTR



Gratings in the petrochemical and other industries

X-BT +
X-FCM R

DX 351 BTG



Interior partition walls (drywall) in interior finishing



X-GN

GX 120



Concrete forms in building construction



X-FS

DX 460



Conduit clips and ties in mechanical and electrical installations



X-EKS, X-ECT

GX 120-ME



2. The direct fastening system

The fastener, tool and driving energy form a **fastening system** with its own specific characteristics. Examples of Hilti direct

fastening system components are shown below.

Fasteners	Fastening tools	Driving energy
		
Powder-actuated tool		
		
Gas-actuated tool		

2.1 Fasteners

Fasteners can be classified in three general types: nails, threaded studs and composite fasteners.

Nails

Siding and decking nails



General purpose nails

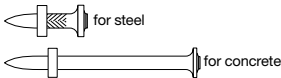

Threaded studs

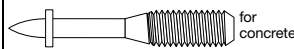
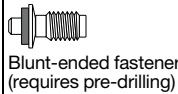
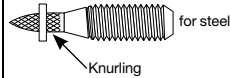

Composite fasteners

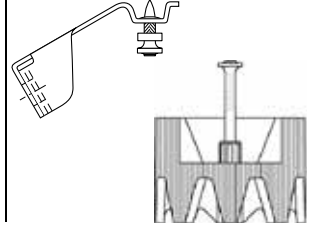

Multi-part fasteners

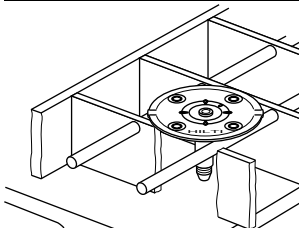

X-FCM grating disk with threaded stud

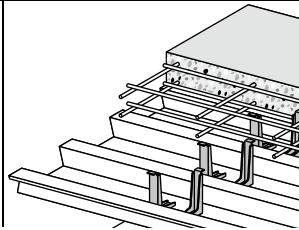

X-HVB shear connectors fastened with **X-ENP-21** HVB nails

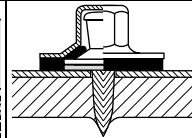

X-ENP nail with **SDK 2** sealing cap

The nails used (also known as drive pins) are of a special type equipped with washers to meet the needs of the application and to provide guidance when driven. Threaded studs are essentially nails with a threaded upper section instead of a head. Composite fasteners are an assembly consisting of a nail with an application-specific fastening component such as a clip, plate or disk made of metal or plastic. Siding and decking nails can be recognized by their washers which are specially designed to hold down the metal sheets and to absorb excess driving energy. Fasteners designed for driving into steel usually have

knurled shanks which increase their pull-out resistance. Fasteners for use on concrete have longer shanks than those for use on steel. Threaded studs may have either a metric (M6, M8 or M10) or Whitworth ($1/4''$, $5/16''$ or $3/8''$) thread.

Nails and threaded studs are commonly zinc-plated for resistance to corrosion during transport, storage and construction. As this degree of protection is inadequate for long-term resistance to corrosion, use of these zinc-plated fasteners is limited to applications where they are not exposed to the weather or a corrosive atmosphere during their service life. The zinc layer on

fasteners driven into steel is, in fact, a disadvantage in that it reduces pull-out resistance. For this reason, the thickness of zinc on the fastener must be optimized to ensure good corrosion protection as well as high holding power. During production, tight control of the galvanizing process is necessary to prevent excess zinc thickness and thereby poor fastening performance. Fasteners must be 2 to 3 times harder than the material into which they are driven. The tensile strength of structural steel is

commonly between 400 and 600 MPa. Fasteners for use on steel thus require a strength of approximately 2000 MPa. As Rockwell hardness is much easier to measure than strength, but good correlation exists between hardness and strength, this characteristic is used as a parameter in the specification and manufacturing of the fasteners. In the table below, HRC hardness is given for a range of tensile strengths (DIN 50150).

Tensile strength (MPa)	770	865	965	1810	1920	1995	2070	2180
HRC	20.5	25.5	30	52.5	54	55	56.5	58

2.2 Manufacturing process

Standard hardened steel fasteners

Almost all powder and gas-actuated fasteners used throughout the world are manufactured from carbon steel wire which is subsequently thermally hardened to provide the strength needed for driving into steel and concrete. In nail manufacturing, shank diameter is determined by the wire diameter used. Threaded studs are made from wire corresponding to the required thread diameter. The manufacturing process, which is summarized in the diagram below, consists of cutting the wire to length, shaping the head, knurling, forging or thermo pulling the point, hardening, galvanizing and assembling with washers.

The process of hardening the steel to more than HRC 50 combined with the zinc plating presents a risk of hydrogen embrittlement.

This risk is mitigated by heat-treating the galvanized product at the optimum temperature for the correct time. Galvanized and heat-treated fasteners are subjected to impact bending tests to check the effectiveness of the process. Depending on their intended application, some fasteners are additionally sampled and tested under tension and shear.

Manufacturing Process

Standard zinc-coated fasteners



Stainless steel fasteners

Hilti introduced the first powder-actuated stainless steel fastener in 1994. These fasteners, which are not thermally hardened, are manufactured from special stainless steel wire with an ultimate tensile strength of 1850 MPa. One effect of using steel of such high strength as a raw material is that the forming and forging processes present greater technical difficulties. These fasten-

ers, on the other hand, suffer no risk of hydrogen embrittlement and their strength decreases only very slightly when subjected to high temperatures such as in a fire.

Manufacturing Process Stainless Steel Fasteners

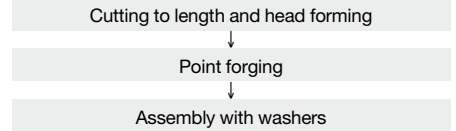

2.3 Fastener raw material

Hilti standard zinc plated fasteners are made from carbon steel wire with an ultimate tensile strength of 590 to 760 MPa.

Hilti **X-CR / X-CRM / X-BT** stainless steel fasteners are made from high-strength nitrogen alloyed stainless steel wire (Hilti designation CR500).

Nickel and chromium are the components of stainless steel that make it resistant to corrosion. CR500 steel is compared to commonly used stainless steels like AISI 304 and 316 (European A2 and A4) in the graph at the right. Note that CR500 steel contains considerably more nickel and chromium than both 304 and 316.

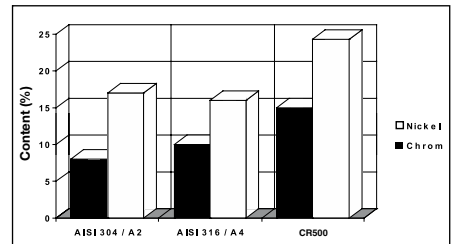

Another comparison of interest is the difference in ultimate tensile strength, as shown in the graph at the right.

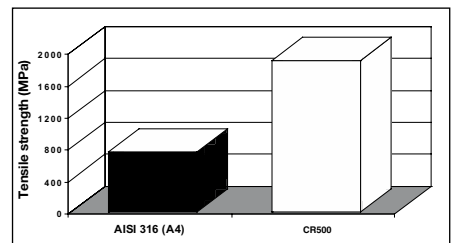

2.4 Powder- and gas-actuated tools

Definitions

In the ANSI A10.3-2006 standard, two basic types of tool are referred to: direct-acting and indirect-acting. The two types are defined by the manner in which the energy is transferred from the hot expanding gases to the fastener.

Direct-acting tool:

The expanding gases act directly on the fastener and accelerate it to a velocity of 400 to 500 m/s (1300 to 1600 fps). This velocity places the tool in the high-velocity class, thereby subjecting it to more stringent rules for usage.

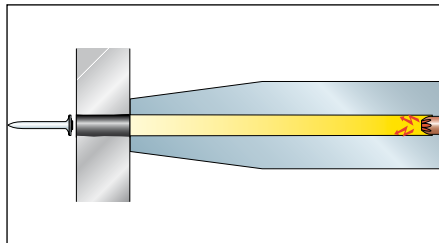

Indirect-acting tool:

The expanding gases act on a captive piston that drives the fastener, which in Hilti indirect-acting tools reaches a velocity of less than 100 m/s (328 fps). Because of the lower velocity, the possibility and extent of injury due to incorrect operation is very much reduced. Rules for usage are less stringent than for high-velocity tools.

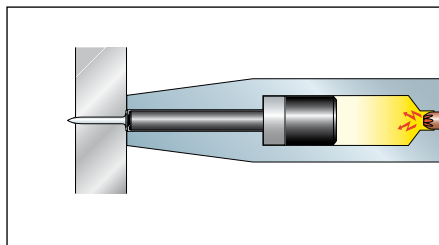

ANSI A10.3-2006 classifies powder-actuated tools according to velocity. With increasing velocity, rules for usage become more stringent, for example with regard to equipping the tools with shields. The lowest velocity tool capable of performing the application should be used.

Class of powder-actuated tool	Average test velocity in m/s [fps]	Maximum single test velocity in m/s [fps]
Low-velocity	100 [328]	108 [354]
Medium-velocity	150 [492]	160 [525]
High-velocity	>150 [492]	>160 [525]

Hilti tools

All Hilti tools supplied for construction applications are low-velocity, indirect-acting tools.

Indirect-acting tools operate according to one of three different principles – co-acting, impact or contact operation – which each affect the operating characteristics and the application limit of the system. It should be noted that 100% co-acting operation can be

achieved by pushing the fastener all the way back against the piston with a ramrod or, if the tool is so designed, with a built-in ramrod mechanism. Tools with nail magazines do not achieve 100% co-action because of the need for clearance between the piston end and the collated nail strip. Some single-shot tools allow the operator to make an impact-type tool work as a co-acting tool by using a ramrod.

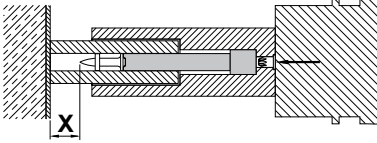
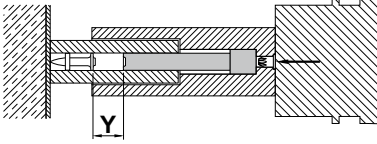
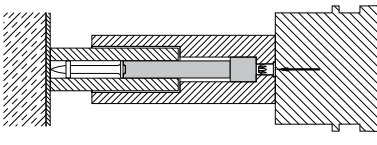
Operating principle	Characteristics	
Co-acting operation	<ul style="list-style-type: none"> • $X > 0$; $Y = 0$ • Highest application limit • Lowest recoil 	
Impact operation	<ul style="list-style-type: none"> • $X = 0$; $Y > 0$ • Lower application limit • Higher recoil 	
Contact operation	<ul style="list-style-type: none"> • $X = 0$; $Y = 0$ • Lowest application limit • Highest recoil 	

2.5 Cartridges (power loads, boosters)

Cartridges for indirect-acting tools are available in various standard sizes and each size is available in up to 6 power levels. In the United States, the powder in a cartridge, the sensitivity of the primer, and the cartridge dimensions are governed by technical data published by the Powder-Actuated

Tool Manufacturers Institute, Inc. (PATMI). PATMI defines the power level by the velocity measured in a standard test in which a standardized 350 grain [22.7gram] cylindrical slug is fired from a standardized apparatus. The identification and limitations of use are addressed in ANSI A10.3-2006.

PATMI colour codes, power levels and definition of cartridges

Size	Colour code	Power level	Velocity of 350 grain slug		Calculated energy (joules)		
			ft./sec.	[m/sec.]	minimum	average	maximum
6.8 / 11 [Cal. 27 short]	Gray	1	370 ± 45	[113 ± 13.7]	111	144	182
	Brown	2	420 ± 45	[128 ± 13.7]	148	186	228
	Green	3	480 ± 45	[146 ± 13.7]	200	243	291
	Yellow	4	560 ± 45	[171 ± 13.7]	280	331	386
	Red	5	610 ± 45	[186 ± 13.7]	337	392	452
	Purple / black	6	660 ± 45	[201 ± 13.7]	399	459	524
6.8 / 18 [Cal. 27 long]	Green	3	550 ± 45	[168 ± 13.7]	269	319	373
	Yellow	4	630 ± 45	[192 ± 13.7]	361	419	480
	Blue	4.5	725 ± 45	[221 ± 13.7]	488	554	625
	Red	5	770 ± 45	[235 ± 13.7]	554	625	700
	Purple / black	6	870 ± 45	[265 ± 13.7]	718	798	883

The German DIN 7260 standard specifies cartridge dimensions, colour codes and power levels, which are defined in terms of energy delivered when a cartridge is fired in

a standardized apparatus. DIN 7260 specifies a 3.66 gram slug with a somewhat more complex geometry than that of the PATMI slug.

DIN 7260 colour codes, power levels and definition of cartridges

Size	Colour code	Power level	Specified energy (joules)
6.8 / 11	White	weakest	120 ± 50
	Green	weak	200 ± 50
	Yellow	medium	300 ± 50
	Blue	heavy	400 ± 50
	Red	very heavy	450 ± 50
	Black	heaviest	600 ± 50
6.8 / 18	Green	weak	200 ± 50
	Yellow	medium	400 ± 50
	Blue	heavy	500 ± 50
	Red	very heavy	600 ± 100
	Black	heaviest	800 ± 100

In order to achieve interchangeability of the tools and cartridges from various manufacturers, PATMI provides guidelines on cartridge dimensions. Manufacturers optimize the cartridge characteristics for their tools in order to achieve functional reliability and long life.

Interchanging of components is mentioned in 7.10 of ANSI A10.3-2006: “Only

those types of fasteners and power loads recommended by the tool manufacturer for a particular tool, or those providing the same level of safety and performance, shall be used.”

It is the responsibility of the user of powder-actuated products to comply with this requirement.

3. Health and safety

The safety of powder-actuated fastening systems can be examined in terms of three general safety characteristics:

- **Operator safety** refers to safeguarding the operator and bystanders.
- **Fastening safety** is a measure of the adequacy of the in-place fastenings.
- **Functional safety** refers to the operability of the tool, especially the operator safety devices, under construction site conditions.

3.1 Operator safety

Hilti powder-actuated systems incorporate five main design features for maximum operator safety – the DX piston principle, drop-firing safety mechanism, contact pressure safety mechanism, trigger safety mechanism and the unintentional firing safety mechanism.

Hilti DX/GX piston principle

One of the main concerns about the use of explosive powder-filled cartridges to drive fasteners is what happens if the base material is missed by the fastener. The piston principle ensures that the energy from the propellant in the cartridge is transferred to a piston, the accelerated mass of which then drives the fastener. Because the piston is captive within the tool, roughly 95% of the driving energy is absorbed by the tool in the event of the fastener missing the base material. Thus, the velocity of a fastener that misses the base material is far lower than the velocities associated with fasteners from high-velocity tools (tools that do not operate with the piston principle).

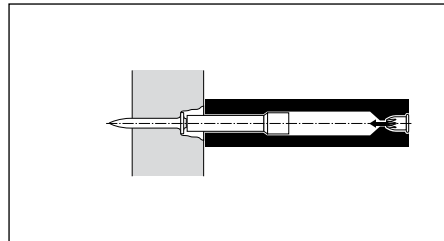
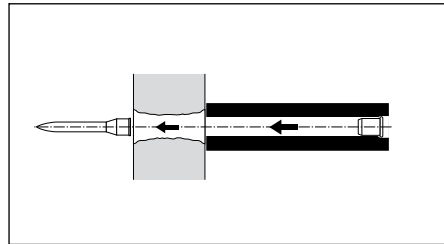

Drop-firing safety

The drop firing safety mechanism prevents the tool from firing if dropped unintentionally. This mechanism is so designed that the tool, cocked or uncocked, will not fire when dropped at any angle onto a hard surface.



Trigger safety

This mechanism ensures that pulling the trigger alone cannot cause the cartridge to fire. The trigger in a Hilti DX- or GX-tool is uncoupled from the firing pin mechanism until the tool is fully compressed against the work surface.



Contact pressure safety

A Hilti tool is made ready for firing by compressing it against the work surface. This requires a force of at least 50 N [11.2 pounds]. Tools with large baseplates that can be easily gripped with the hand, for example the DX 76 and the DX 460 SM, GX 120, have an additional surface contact pin that must also be pushed back to allow firing. This is designed to prevent the tool firing when its nosepiece is not in contact with the work surface.

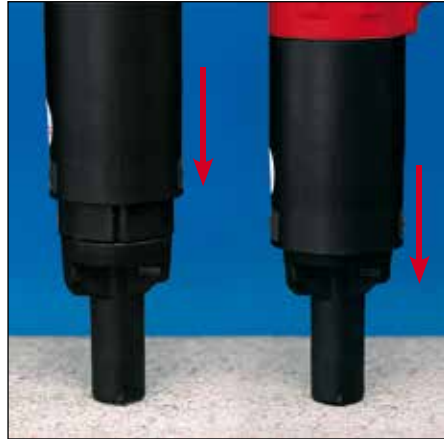

Unintentional firing safety

Hilti DX tools cannot be fired by pulling the trigger and then compressing the tool against the work surface (also known as “bump firing”). These tools can be fired only when they are (1) compressed against the work surface and (2) the trigger is then pulled.



Cartridge (power load or booster)

The propellant powder in the cartridge can only burn if the primer burns first. Burning of the primer is initiated by an impact applied with the correct velocity at the correct location of the cartridge. The propellant and primer are protected from external influences by the metal casing of the cartridge.

Magazine strip

Collated cartridges in strips of 10 (or 40) offer greater safety because the plastic strip helps protect the cartridge cases from impacts and ensures separation between the cartridges.

Packaging

The packaging must contain provisions with respect to tool compatibility.

Promotion of operator safety

Safety of the operator and bystanders is promoted by use of the appropriate safety equipment and by following the instructions in the operator’s manual. By supplying the powder-actuated tool in a lifetime kit box with space for eye protectors, operator’s manual, etc., retention and use of the safety equipment is much improved.

Tool compatibility information and installation guidelines printed on the cartridge and fastener packaging supplement the operator’s manual.



Hilti organizes operator training courses in which general safety measures for powder-actuated tools are covered as well as measures specific to each model of tool used. In some countries, certificates or operator IDs are issued upon completion of training courses to encourage attention to safety by operators and to allow safety officials to enforce training requirement regulations.

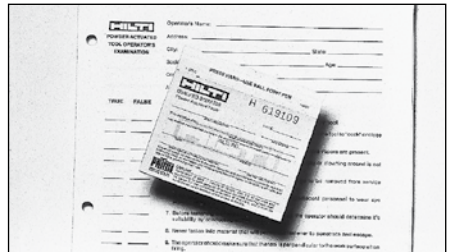

3.2 Fastening safety

Fastening safety depends on a correct prediction of the loads and the conditions to which the fastening is subjected and a correct prediction of fastening performance. The necessary conditions for predictable fastening performance are:

1. The fastening system must have been engineered and tested for the application.
2. The quality of the fastening system components used must correspond to the quality of those originally tested.
3. The fastenings must be made as foreseen in the engineering of the system or in the same way as when the system was tested.

Engineering and testing

Sources of information about the engineering and testing of a fastening system are the manufacturer's technical literature, test reports, official approvals and publications in technical journals. If an "or equal" clause is used in the specification, then approval of any alternate fastening system should be made contingent on provision of documentation showing that the proposed fastening system has been engineered and tested for the given application.

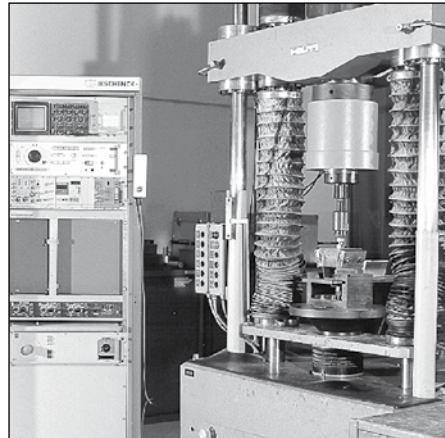

Production quality

The need for the materials used on the job-site to correspond to the design of the product and to be of the same quality as those tested is clear. This requires the manufacturer to have a production quality control system, which is necessary for ISO 9001 certification.

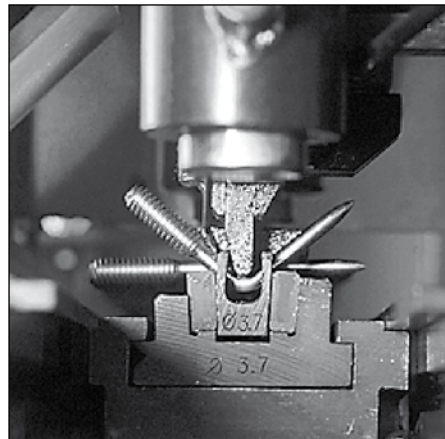

Quality of installation

The use of fastening systems for which the manufacturer provides application guidelines and a technical advisory service helps ensure that fasteners will be installed correctly. The concept of controlling the quality of the work must include some feature that can be measured and that feature must indicate the performance of the fastenings.

The primary means of checking the quality of a powder-actuated fastening is by checking the stand-off over the surface of the fastened material. For fasteners that do not allow an accurate visual check of the stand-off, the use of a stand-off template is recommended. In some cases tensile testing of fasteners on jobsites is necessary. Threaded studs and some decking fasteners with suitable head design can be tensile-tested in their final position on a jobsite. Other fasteners like simple flat-headed nails have to be driven through a pull-over test specimen and then tested.



Checking the standoff of an X-EDN 19 roof deck fastening with a plastic template



Pull-out test of an ENP fastening with a Mark V tester and ENP adapter

3.3 Functional safety

Construction professionals demand fastening systems that are dependable under the toughest jobsite conditions. The goal of functional reliability has to be integrated into the development, manufacture, sales and service of a fastening system. The development of a new fastening system must consider the operating conditions and the degree of reliability required. During development, system components and prototypes are tested to determine if they will function reliably. Pilot production lots are tested by contractors on their jobsites to ensure that the design can be produced in a quality that will function. Quality control is integrated in the manufacturing process to ensure that all components are manufactured according to specifications. Salespersons are trained so that they can advise their customers as to the proper system to use for the application. Tool repair and maintenance training help keep the fastening systems functioning.



Lifetime testing of the DX powder-actuated tool with nail magazine

3.4 DX Cartridge safety

Important information about cartridges for powder actuated fastening tools

Only use Hilti cartridges or cartridges of equivalent quality.

The use of cartridges of inferior quality in Hilti tools may lead to build-up of unburned powder, which may explode and cause severe injuries to operators and bystanders.

At a minimum, cartridges must:

1. be confirmed by their supplier to meet the „Combustion residue test“ according to EU standard EN 16264,

or

2. bear:

- The CE conformity mark
- The proof mark of fire-arm test house
- The tool designation
- The identification number of the EU notified body
- The number of the type test

For example:



3.5 DX Tools safety

Approvals for powder actuated fastening tool:

Hilti Powder Actuated Fastening tools are designed and tested according to “Directive 2006/42/EC” and are CIP approved.

Identifications on the Hilti DX tools:



4. Corrosion

For decades, Hilti is concerned about corrosion of fastening systems and has gained a lot of experience in this area based on laboratory- and field tests. Extensive testing and research are conducted in test facilities of Hilti Corporate Research department, located around the world in different climate zones.

Hilti strives to provide the best possible

support to customers for selecting the right product for safe and reliable fastening solutions.

This chapter gives an overview of corrosion protection solutions for Hilti Direct Fastening elements. More details on corrosion are described in the Hilti corrosion brochure „Corrosion aspects of fastening systems 2010“.

4.1 Corrosion protection of direct fastening systems

The use of the corrosion protection system is dependent on different influencing parameters. Following table shows typical environmental and application conditions affecting the corrosion process.

Humidity	<ul style="list-style-type: none"> • Humidity accelerates corrosion.
Temperature	<ul style="list-style-type: none"> • Higher temperatures promote corrosion.
Salts	<ul style="list-style-type: none"> • Salt accelerates corrosion.
Industrial pollution	<ul style="list-style-type: none"> • SO₂ accelerates corrosion.
Galvanic corrosion	<ul style="list-style-type: none"> • Occurs when fastener is less noble than fixed parts.
Special applications	<ul style="list-style-type: none"> • Include other influencing factors, i.e. indoor swimming pools, road tunnels, chemical industry.

Galvanic zinc coating

A typical corrosion behavior of galvanized zinc coated fasteners is characterized by a rather homogeneous surface reduction. It begins with zinc corrosion (white rust) till the zinc is completely removed. Corrosion of the carbon steel material will then take place (red rust).

Zinc corrosion (white rust)



Start of carbon steel corrosion (red rust)



The amount of material loss due to corrosion can be approximated in laboratory scale experiments. The so-called corrosion rate is generally listed as mm/year or g/m² h (laboratory values).

Hydrogen embrittlement

A specific corrosion phenomenon of zinc plated DX fastening elements is hydrogen embrittlement, which will transpire if three different conditions are present simultaneously:

- High strength steel (≥ 1000 MPa)
- Presence of hydrogen
- Tensile stresses

Corrosion occurs when zinc plated, high-strength fastening element is used in wet atmosphere. During this corrosion process, hydrogen is formed and diffuses into the material. This leads to a decrease in ductility of the material, leading to sudden fastener failure even under very low static load.

Hilti’s power actuated fasteners are thoroughly tested and controlled to prevent primary hydrogen embrittlement during the production process. To avoid secondary hydrogen embrittlement during the service life of a fastener when installed, the application conditions given for each nail in this document and other Hilti Literature must be followed.

Duplex coating

Duplex coating is a two layer coating consisting of a sealer layer with a zinc layer below. The sealer prevents the zinc from corrosion, so the duplex coating has got a higher corrosion protection than standard zinc plating.

Stainless steel

There is a wide range of different types of stainless steel, and they each have different corrosion resistance properties. A stainless steel material used in a wrong environment can lead to pitting corrosion and, subsequently, sudden fastener failure. In such a situation, prediction of fastener lifetime is not possible.

Hilti power actuated fasteners are made of CR500 and 1.4462 material, similar to A4 (AISI grade 316) and, for higher corrosion requirements, HCR (1.4529) material. The HCR (High Corrosion Resistance) material can be used in swimming pools and in road tunnels, where A4 material is not sufficient.

Stainless steel with pitting corrosion, e.g.
A4 material used in a road tunnel



Suitable stainless steel used, e.g. HCR
material used in a road tunnel













4.2 Fastener selection

Following table (page 305) gives a general guideline of commonly-accepted applications in typical atmospheric environments. Suitability of fastening systems for a specific application can be significantly affected by localized conditions, including but not limited to:

- Elevated temperatures and humidity
- High levels of airborne pollutants
- Direct contact with corrosive products, commonly found in chemically-treated wood, waste water or salt water, concrete additives, cleaning agents, etc.

- Non-atmospheric corrosion like e.g. direct contact to soil, stagnant water
- Cyclical wetting
- Electrical current
- Contact with dissimilar metals
- Physical damage or wear

Environmental conditions		Fastened part		Carbon steel		Stainless steel	
				Galv. zinc coating	Duplex coating	CR500 or 1.4462 (A4, AISI 316)	HCR 1.4529
				Fastener X-ENP ¹ , X-U X-FCM-M X-BT, X-CR On demand X-GHP X-FCM-R			
		Dry indoor	steel (zinc coated, painted), aluminum, stainless steel, wood	■	■	■	■
		Indoor with temporary condensation	steel (zinc coated, painted), aluminum, stainless steel, wood	Consult experts for exceptions	■	■	■
		Outdoor, non-safety relevant ²⁾	steel (zinc coated, painted), aluminum, wood	■	■	■	■
		Outdoor, rural or urban environment with low pollution	steel (zinc coated, painted)	—	■	■	■
			aluminum, stainless steel	—	Consult experts for exceptions	■	■
		Outdoor, rural or urban environment with moderate concentration of pollutants and/or salt from sea water	steel (zinc coated, painted)	—	Consult experts for exceptions	■	■
			aluminum, stainless steel	—	Consult experts for exceptions	■	■
		Coastal areas	steel (zinc coated, painted), aluminum, wood	—	—	■	■
	0-1 km	Outdoor, areas with heavy industrial pollution	steel (zinc coated, painted), aluminum, wood	—	—	■	■
	0-10 m	Close distance to streets	steel (zinc coated, painted), aluminum, wood	—	—	■	■
	Special applications	Road tunnels, indoor swimming pools, special applications in chemical industry	steel (zinc coated, painted), aluminum, wood	—	—	Consult experts for exceptions	■

■ = expected lifetime of power actuated fasteners made from this material is typically satisfactory in the specified environment based on the typically expected lifetime of a building. The assumed service life in ETA approvals for power actuated fasteners is 25 years.

— = fasteners made from this material are not suitable in the specified environment. Exceptions need a specific assessment.

1) Outdoor exposure for up to 6 months during construction is permissible for high-strength electro-galvanized siding and decking fasteners such as the X-ENP (see instructions for use for details)

2) The reference to “non-safety relevant” is intended to distinguish applications where failure of the attachment will not create any potential safety risks or significant damage.

Remarks:

- The ultimate decision on the required corrosion protection must be made by the customer. Hilti accepts no responsibility regarding the suitability of a product for a specific application, even if informed of the applications conditions.
- This table is based on an average service life for typical applications.
- For metallic coating e.g. zinc layer systems the end of life time is the point where red rust is visible over a large percentage of the product and widespread structural deterioration can occur – the initial onset of rust will occur much sooner
- National or international codes, standards or regulations, customer and/or industry specific guidelines must be independently evaluated.
- These guidelines apply to atmospheric corrosion only. Other types of corrosion, such as crevice corrosion or stress corrosion cracking must be independently evaluated.

A typical service life of Hilti GX-WF nails in wood - wood connections is shown below:

Service Classes in accordance with EN 1995 (Eurocode 5):		Service Class 1	Service Class 1,2	Service Class 1,2,3			
Type of Corrosion Protection for Hilti GX-WF wood nails (d ≤ 4mm):		No Corrosion Protection	Zinc coated	HDG	A2 ¹⁾	A4	
		Dry indoor	20 to 50 years	up to 50 years	up to 100 years	■	■
		Indoor environments with temporary condensation	—	10 to 50 years	60 to 100 years	■	■
		Outdoor with low pollution	—	5 to 20 years	40 to 100 years	■	■
		Outdoor with moderate concentration of pollutants	—	2 to 10 years	20 to 40 years	■	■
		Coastal areas	—	up to 5 years	10 to 30 years	—	■
		Outdoor, areas with heavy industrial pollution	—	up to 5 years	10 to 30 years	—	■
		Close distance to streets	—	—	—	—	■
	Special applications	Special applications	Consult experts for exceptions				

The table above provides typically assumed service life estimations based on corrosion considerations. Other factors determining the service life of fasteners must be evaluated separately.

- = expected lifetime of nails made from this material is typically satisfactory in the specified environment based on the typically expected lifetime of a building.
- = nails made from this material are not suitable for the environment or the typical lifetime of a building is not achieved.

1) For nails made of A2 material, discoloration of nail heads can occur before the service life in the table above is reached. To avoid this, use A4 material.

Remarks:

- The use of certain wood species including, but not limited to, Oak, Douglas-fir or Western Red Cedar, require the use of stainless steel nails, independent of Service Class and environmental conditions.
- The use of certain wood treatments including, but not limited to, fire retardants or preservatives can change the chemical composition of the wood and may require the use of stainless steel nails, independent of Service Class and environmental conditions.
- The evaluation of corrosive environmental conditions depends on many factors and lies within the responsibility of the customer. The planned service life of the buildings or structures can be considered according to local or national building regulations and Eurocode (EN 1990)
- The table does not contain recommendations and Hilti does not assume liability for fastener selection based on its content.
- For the typical service life, it is assumed that the nails are selected, designed, installed and otherwise treated in accordance with Hilti's published literature.
- Local building regulations and trade rules may differ from the table above. The local jurisdiction always needs to be followed.
- Wood to steel connections may require a minimum corrosion protection, independent of the environmental conditions.

5. Steel base material

5.1 Anchoring mechanisms

The following four mechanisms cause a DX- / GX-fastener to hold when driven into steel:

- clamping
- keying
- fusing (welding)
- soldering

These mechanisms have been identified and studied by analyzing pull-out test data and by microscopic examination of fastening cross-sections.

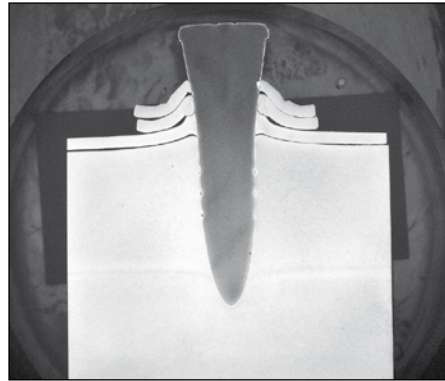

Clamping

As a fastener is driven, the steel is displaced radially and towards both the entry and opposite surfaces. This results in residual pressure on the surface of the nail, which leads to friction or clamping. Clamping is the primary anchoring mechanism of through-penetrating fasteners. This is indicated by the fact that when through-penetrating fasteners are extracted, the pull-out force decreases only slowly over several millimeters of displacement.

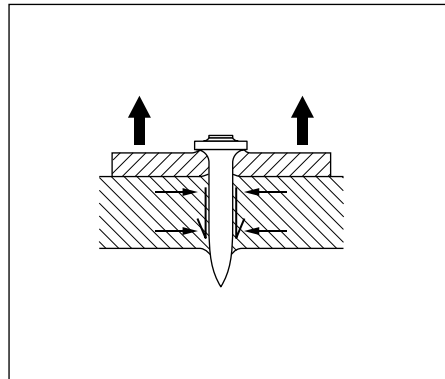

Keying

The keying mechanism is possible when the fastener is knurled, that is, it has fine grooves along the shank in which zinc and particles of base steel accumulate during the driving process. Microscopic examination of cross sections has shown that the grooves are not completely filled. Keying is an especially important anchoring mechanism for fasteners that do not penetrate right through the base material.

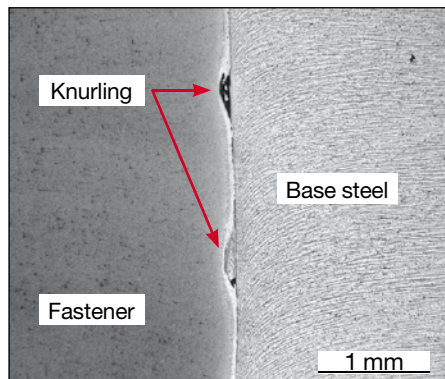

Fusing (welding)

Complete fusing of the fastener with the base steel is indicated by portions of base material clinging to the extracted fastener as well as by the decarbonized zone. Fusing or welding is observed mostly at the point of a fastener where the temperature during driving can be expected to be the highest.

For fasteners that do not through-penetrate, this is an important anchoring mechanism. It can be relied upon only if the fastener point is manufactured without cracks and with an appropriate geometry. The thermo pulling process is ideal for achieving an optimized geom-

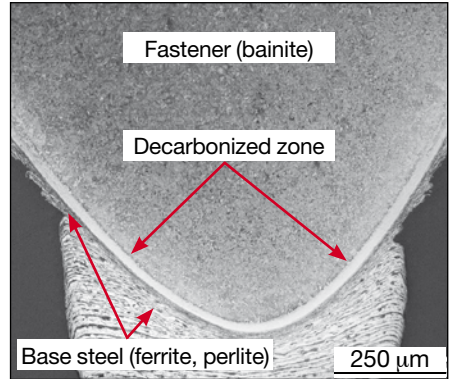

etry. Control of all steps in the production process is necessary to avoid cracks in the point.

Soldering

In the zone further from the point, there is a prominent zinc layer separating the fastener from the base steel. This zinc, soldered to the base steel, also makes a contribution to the pull-out resistance of the fastener.

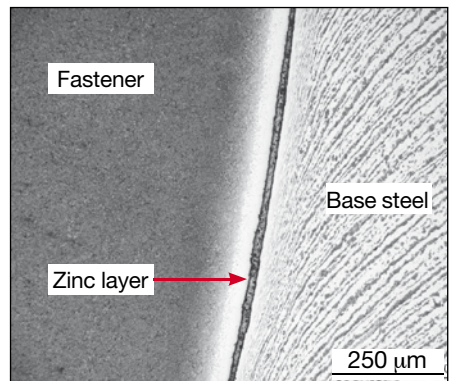

Blunt-tipped fastener X-BT

The X-BT fastener with a shank diameter of 4.5 mm is driven in a pre-drilled 4.0 mm diameter hole. This leads to displacement of the base material. Part of the base steel is punched down into the pre-drilled hole, generating high temperatures and causing friction welding. Due to elasticity of the base steel, additional clamping effects are also superposed. Displaced base material can be clearly seen in the photograph. Base material adhering to the fastener shank indicates a welding effect.



5.2 Factors influencing pull-out resistance

Powder-actuated fastening systems must be designed and manufactured to ensure that pull-out resistance will be adequate for the applications intended. Through understanding of the anchoring mechanisms, experience and testing, factors that influence pull-out strength have been identified. Some of these factors are:

- Depth of penetration in the base material
- Surface characteristics of the fastener
- Coatings on the steel base material
- Driving velocity
- Diameter of the fastener shank

Knowledge of the influencing factors is vital to the design of fastening systems and is useful for operators in understanding the various application guidelines and restrictions that apply to a fastening system. Some of the influencing factors are discussed in the following section.

Depth of penetration in the base material

The depth of penetration of fasteners in steel is taken as the distance that the point travels below the surface of the base steel, independent of the steel thickness. In other words the depth of penetration h_{ET} can be greater than, equal to or less than the steel thickness.

Resistance to pull-out increases with increasing depth of penetration. This is also true for through-penetrating fasteners where h_{ET} is greater than the steel thickness.

The design of a powder-actuated fastener has to take into account the depth penetration necessary to achieve the pull-out resistance required for the application. Application guidelines published for any fastener include the required nail head stand off h_{NVS} , which corresponds to the penetration depth.

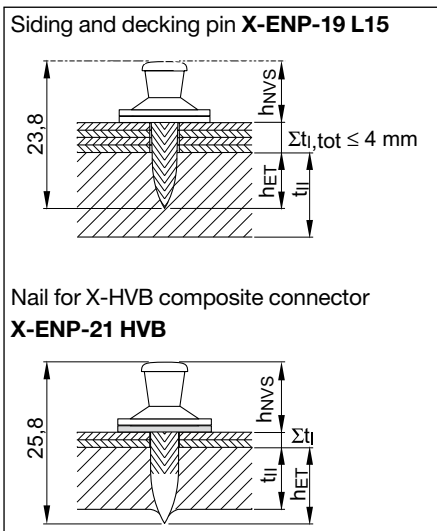

Guide values for the depth of penetration of specific fastener types are as follows:

- Galvanized fastener with knurled shank: $h^{ET} = 12$ to 18 mm (shank diameter 4.5 mm)
- Galvanized fastener with knurled tip: $h^{ET} = 10$ to 14 mm (shank diameter 3.7 mm)
- Galvanized fastener with knurled tip: $h^{ET} = 9$ to 13 mm (shank diameter 4.5 mm)
- Galvanized fastener with smooth shank: $h^{ET} = 15$ to 25 mm
- Stainless steel fastener with smooth shank: $h^{ET} = 9$ to 14 mm
- Blunt-ended fasteners: $h^{ET} = 4$ to 5 mm

The effect of penetration depth on pull-out strength can be demonstrated in experiments in which the driving energy is varied so as to produce varying penetration. The results of a test of this kind are summarized below. The application recommendations for fasteners are based on tests like these and they clearly show the importance of carrying out the fastening work in accordance with the recommendations of the manufacturer.

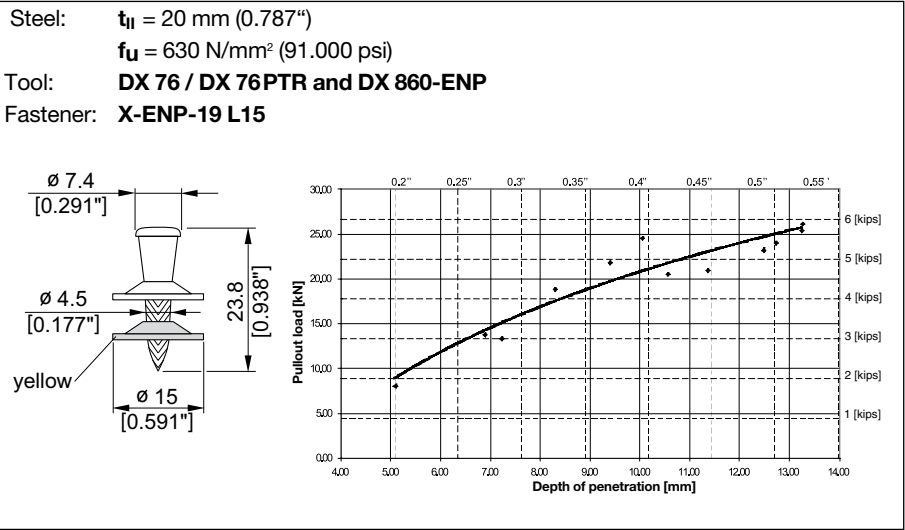

Knurling on the fastener shank

Fasteners for use in steel base material usually have knurling on the shank so as to improve the resistance to pull-out. The effect of the knurling was shown in a test with fasteners that had knurled and unknurled shanks, but were otherwise the same.

The benefit of knurling is clearly seen from the test results. With virtually the same penetration (actually 106%), the smooth-shank fastener had only 68 % of the pull-out strength of the knurled-shank type. Even with the penetration increased to 137 %, the pull-out strength was still only 81 % of that of the knurled-shank fastener. In this test, the steel thickness of 10 mm (0.394") allowed through penetration of the steel. If the steel is too thick for through penetration, the beneficial effect of knurling becomes even more pronounced.

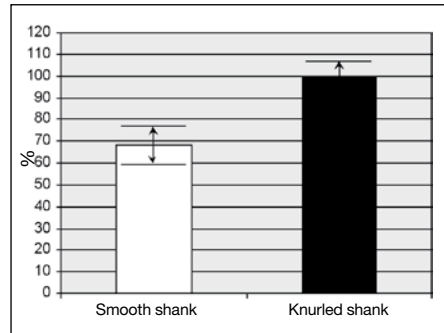

Zinc coating on the fastener shank

Zinc on a fastener shank appears to act as a lubricant that reduces its resistance to penetration into steel. Reduced pull-out strength results because the lower resistance means less heat is generated, thus reducing the welding effect between the shank and the base steel. This was shown in an experiment with fasteners that were identical except for the thickness of zinc coating.

Steel base material: $t_{II} = 20 \text{ mm}$ [0.787"],

$f_u = 440 \text{ MPa}$ [63,817 psi]

Zinc thickness in mm	Average penetration h_{ET}		Average ultimate pull-out load $N_{u,m}$		Variation CV %
	mm / [in.]	%	kN / [kip]	%	
ca. 10	12.12 [0.477]	100	8.53 / [1.918]	67	25.6
2–5	11.86 [0.470]	98	12.82 / [2.882]	100	9.3

Although driving the fastener through sheet metal, as is the case when fastening siding and decking, reduces the negative effect of zinc coating on pull-out strength, the reason for tightly controlling the galvanization process is clear.

Surface of the steel base material

Corrosion protection of structural steel is often achieved by hot-dip galvanizing. Tests have shown that if the fastener penetrates right through the steel, the galvanizing has no significant effect on pull-out strength. In the case of fasteners that do not through-penetrate, pull-out strength is reduced by about 25%. The summary of results from one test is shown below to illustrate these effects.

Average ultimate pull-out loads

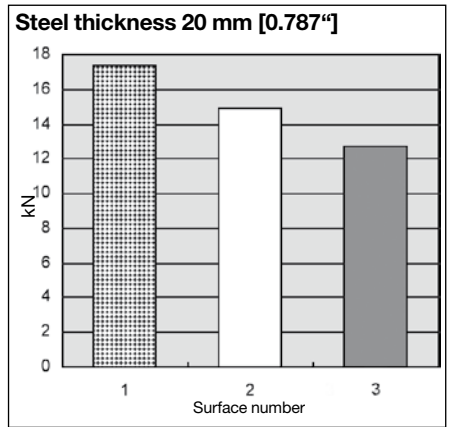
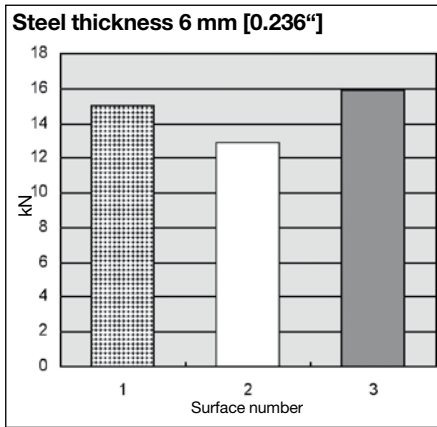

Ultimate tensile strength of steel :
Surface of the steel :

$f_u = 430 \text{ MPa [62,366 psi]}$
1. Rough with some slag and rust (reference)
2. Sandblasted
3. Pickled + hot-dip galvanized (min. 60 μm zinc)

Several important observations can be made based on these results:

- Pull-out loads in 6 mm ($1/4''$) steel base material are much less affected by the surface condition of the steel than they are in 20 mm ($3/4''$) steel. The reason is that the main anchoring mechanism of through-penetration fastenings is clamping, which is not affected by the surface condition of the steel.
- Hot-dip galvanizing appears to reduce the pull-out strength of non-through-penetrating fastenings by nearly 30%. Note, however, that even with hot-dip galvanizing, the pull-out strength was still 12.5 kN (2.8 kips).
- The negative effect of hot-dip galvanizing is explained by the tendency of zinc on the fastener to act as a lubricant that reduces heat generation during driving. This in turn reduces the tendency of the fastener point to fuse to the base steel. Zinc from the coating on the base steel apparently becomes attached to the fastener as it enters the base steel.

For applications where tensile strength of the fastening is critical and the steel has a heavy coating, the fastening system can be qualified by carrying out pull-out tests on site. If pull-out strength is not adequate, depth of penetration can be increased to improve the situation.

Tensile stress in the steel

The integrity of a powder-actuated fastening is dependent on a relatively smooth pin remaining anchored in structural steel. A large amount of test data, technical assessments, approvals and practical experience with powder actuated fastenings is available to support use of powder-actuated fastening. Performance of fasteners anchored in the steel under tension was investigated by driving fasteners into unstressed steel plates and extracting them with the plates stressed in tension. The steel plates measured 6 · 80 · 455 mm [0.236" · 3.15" · 17.9"] and possessed two different yield stresses - 328.6 MPa [47.7 ksi] and 411.7 MPa [59.7 ksi].

By expressing the steel stress in terms of % of actual yield, it was possible to combine the data for both steel grades and obtain a reasonable curve fit.

Of significance to the designer is the expected decrease in pull-out strength of the fastener at a typical maximum allowable design stress of 60 to 70 % of yield. At this stress, the pull-out strength reduction is less than 15%. The absolute value in the experiment was still greater than 2 tons.

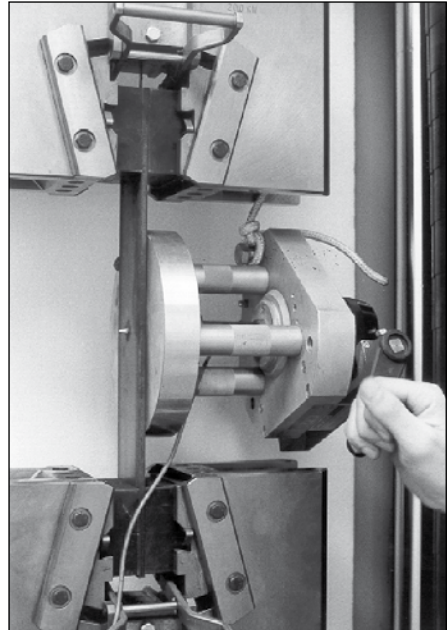
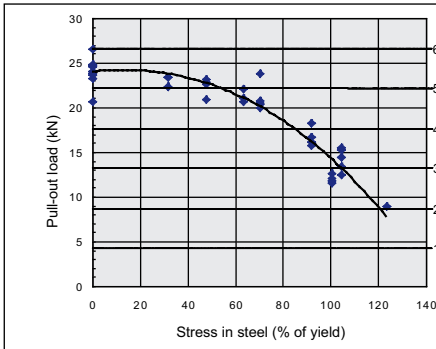

Compressive stress in the steel

Compressive stress in the base steel has no influence on the pull-out strength of the fastener. This was demonstrated by placing fasteners in unstressed 15 mm [0.59"] thick steel plates having a yield strength of 259.3 MPa [37.6 ksi] and extracting them while the plates were compressed in a testing machine.

The minimal variation in pull-out load is simply random variation experienced in testing.

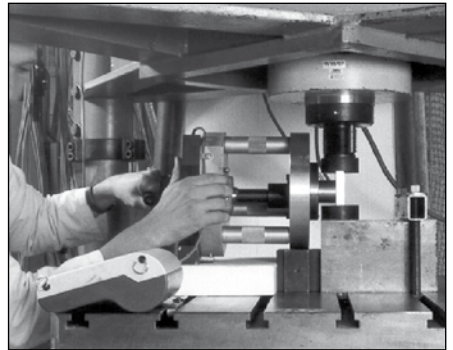
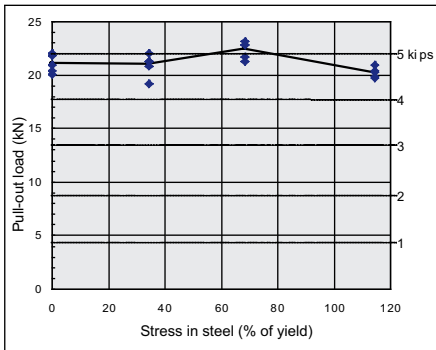

5.3 Suitability of the steel for fastening

There are three main factors determining the suitability of a construction grade steel member for DX fastening:

- Steel thickness
- Ultimate tensile strength
- Flexibility of the base steel member

5.4 Application limit diagrams

The application limit of a fastening system is a term applied to a combination of the maximum thickness t_{fl} and ultimate tensile strength f_u of steel in which fastenings can be made.

There are two general types of application limit diagrams:

- Short fasteners (e.g. siding and decking nails and threaded studs)
- Long fasteners (e.g. nails used to fasten wood to steel)

The application limit line for a **short fastener** is a plot of steel thickness versus ultimate tensile strength. In situations represented by steel thickness / ultimate tensile strength combinations above and to the right of the line, some of the fasteners may shear off during driving. The failure surface will be roughly at a 45° angle to the shank length.

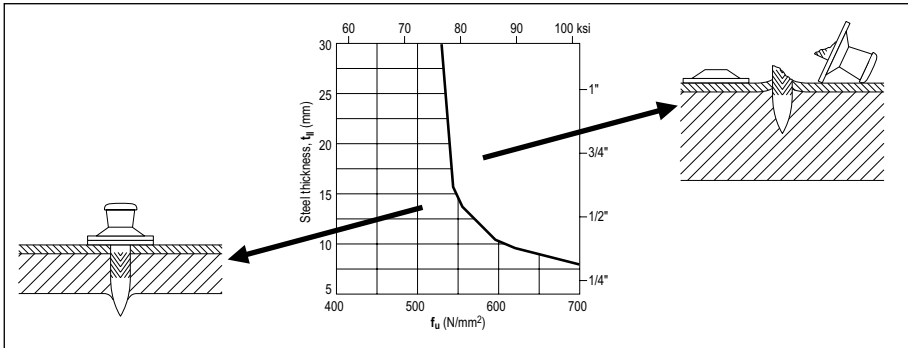

The application limit lines for **long nails** used to fasten **wood to steel** are plots of nail shank length L_s versus steel thickness t_{fl} . Each line is valid only for one ultimate tensile strength of steel f_u . Attempts at working to the right of the limit line result in buckled nail shanks.

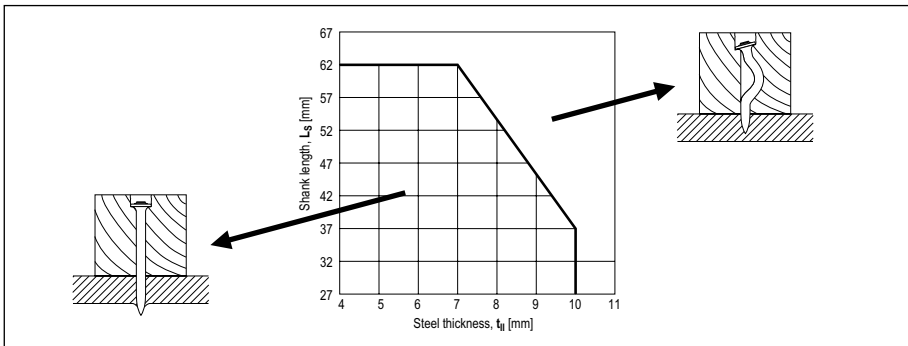

5.5 Thin steel base material

In the context of powder-actuated fastening, steel is considered thin when flange deformation during driving dominates fastener design. When the steel flange is thinner than about 6 mm [0.25"], flange deformation makes use of fasteners with a 4.5 mm [0.177"] shank diameter more difficult and switching to a 3.7 mm [0.145"] shank fastener leads to better results. Use of fasteners with tapered shanks and energy-absorbing washers improves performance and reliability.

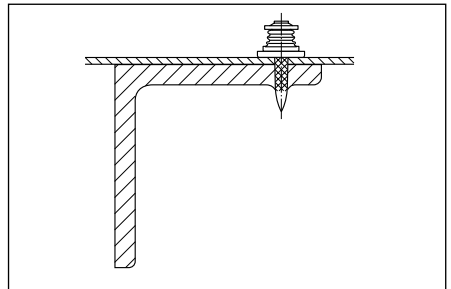
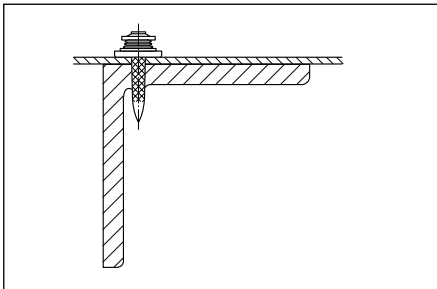

A fastener can penetrate into steel only when the steel (flange) develops a resistance greater than the force required for penetration. This implies the use of energy in excess of that required for penetrating into the steel. In fact, if the driving energy remains constant, fasteners placed closest to the web will be driven deepest. All siding and decking fasteners should have a mechanism to clamp the sheets down tightly over the entire range of allowable standoffs. This is especially critical for fasteners used for fastening to thin steel.

Obviously, under shear loading, failure of the base material is more likely with thin steel than with thick steel. When approving fastening systems for a project, it is important to consider whether the system has actually been tested with thin base steel or not.

Hilti's general recommendation for thin base steel fasteners is to place the fastenings within $b_x = 8 \cdot t_{fl}$ of the web.

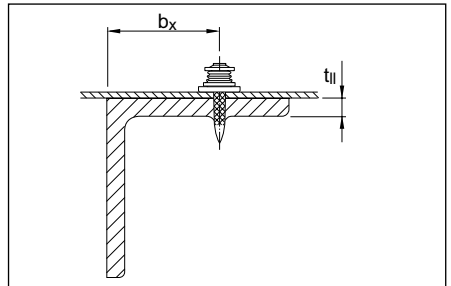
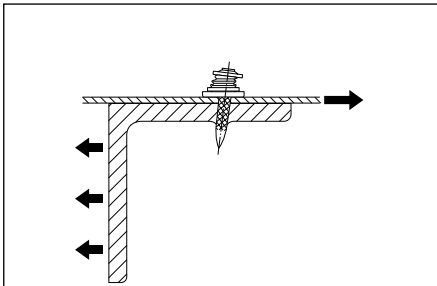

5.6 Types of load and modes of failure

5.6.1 Shear loads

The shear loads acting on siding and decking fasteners come from:

- Diaphragm action of the fastened sheets
- Forces of constraint (for example due to temperature changes)
- Self-weight of siding material

Testing

Shear testing of siding and decking fastenings is done using specimens made up of a strip of sheet metal fastened to a steel plate. Suitable, non-slip fixtures have to be used at either end. In some cases specimens are bent up at the sides to hinder eccentricity.

Failure of the fastened material

The load-deformation curves of shear tests with powder-actuated fasteners show a nearly ideal behavior. After an initial elastic phase during which the clamping force of the washers against the sheet metal is overcome, the sheet metal reaches its yield stress in an area where the fastener bears against it. Then the fastener shank cuts through the sheet metal until the end of the sheet is reached. The large area under the load-deformation curve represents energy absorbed, and this is what makes the fastening method ideal for diaphragms.

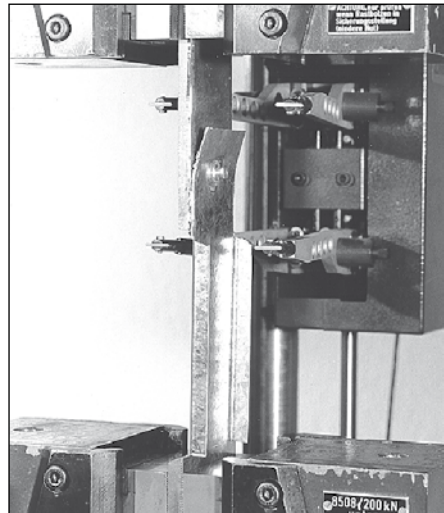
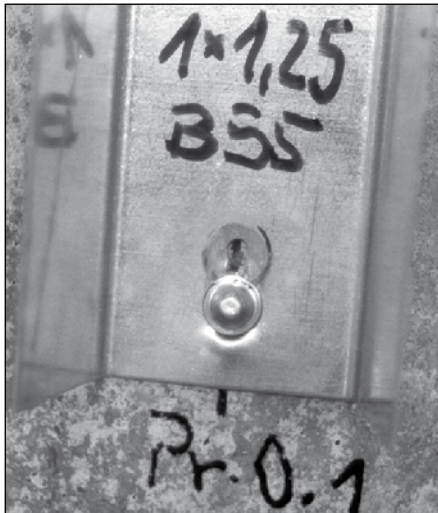

Failure of the base steel

If the thickness of the fastened sheet metal is large compared to the base steel thickness, bearing failure of the base material is a possible mode of failure.

Pull-out from the base steel

The unavoidable eccentricity in the shear test specimen leads to a tensile load component on the fastener. Thick fastened material and thin base material is also involved in this mode of failure. This failure mode is generally not governing for base material thickness of $t_{II} > 6$ mm.

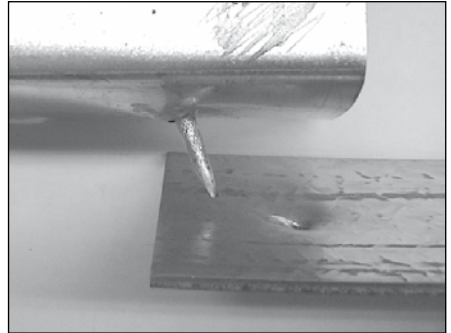

Fracture of the fastener

About 20 kN (4.5 kips) of force is required to shear the Ø 4.5 mm (0.177") shank of an **X-ENP-19 L15** fastener. With about 2.5 mm (12 gauge) thick steel sheet as fastened material, a force of this magnitude could be possible. The force needed to break a Ø 3.7 mm (0.145") shank of an **X-EDNK22 THQ12** fastener is about 13 kN (2.9 kips). This force can be generated with 1.5 mm (16 gauge) sheet steel. In practice, this failure mode is likely only where expansion joints are not provided to relieve forces of constraint from temperature differences.

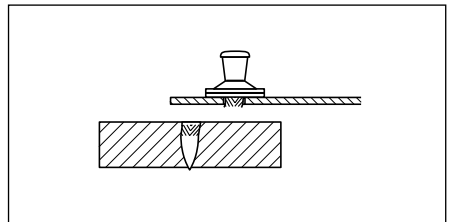

5.6.2 Tensile loads

The most common source of tensile loading on siding and decking fasteners comes from wind suction acting on the roof or wall cladding. In diaphragms, fasteners can be subject to tensile loads in situations where the combination of geometry and thickness of decking fastened leads to prying. In designs with very stiff decking and wide beams or unbalanced spans, prying can also be caused by concentrated loads.

Testing

Tensile testing of siding and decking fastenings is carried out using specimens made up of a trapezoidal-shaped piece of sheet metal fastened to a steel plate. Suitable, vice-like fixtures are used to grip the specimen. This is often referred to as a pull-over test because the common failure mode is the sheet pulling over the washers or the head of the fastener. If the sheet thickness fastened is increased so that pull-over does not govern, pull-out will be the failure mode.

Some fasteners like the Hilti X-ENP have a head that can be gripped and pulled out by a suitable fixture. With these fasteners, a pull-out test can still be done even if pull-over is the original mode of failure. This fastener type has the further advantage of allowing in-place fasteners on a jobsite to be tested.

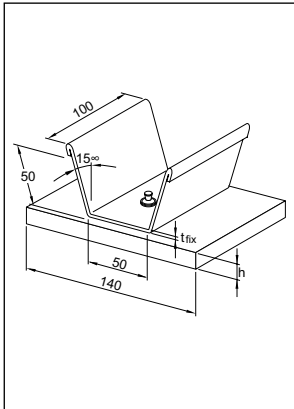

Pull-over test specimen

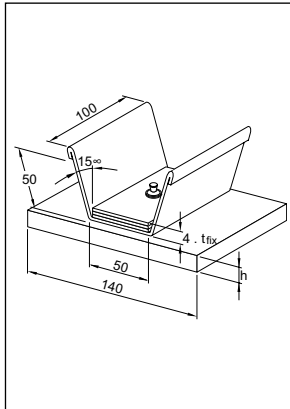

Pull-over test specimen with 3 extra layers to simulate end lap – side lap

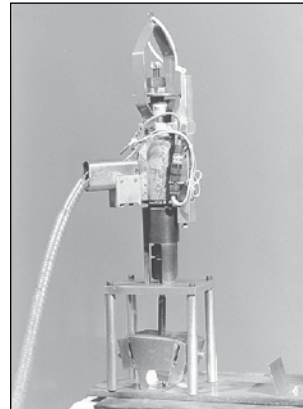

Test setup

Sheet pull-over

In this failure mode, the sheet tears and is lifted up over the fastener head and washers. Depending on the sheet thickness and tensile strength, the washers may be bent up.

Washer pull-over

Another possible failure mode is that of the washers being pulled up over the head of the nail. Obviously, this happens when the sheet is somewhat stronger and /or thicker than when sheet pull-over occurs. This failure mode is also heavily dependent on fastener design.

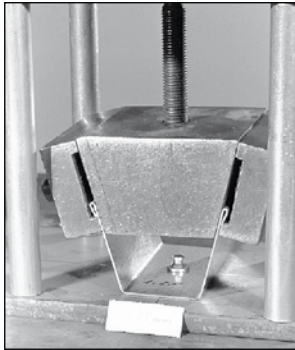

Pull-over test specimen at test start

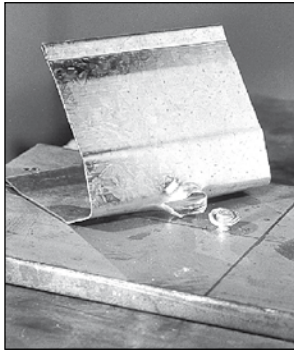

Sheet pull-over

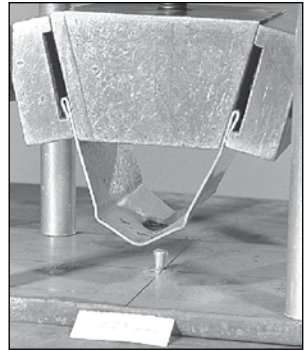

Washer pull-over

Pull-out from the base steel

As sheet thickness and number of layers is increased, this failure mode becomes more likely. For a properly driven **X-ENP-19 L15** pull-out from the base steel is not a likely mode of failure. The head and washer design of the **HSN24** or **X-EDNK22 THQ12** fasteners can allow this failure mode, especially with multiple layers of sheets.

Fracture of the fastener

A force of more than 30 kN [6.7 kips] is required to break the Ø 4.5 mm [0.177"] shank of an **X-ENP-19 L15** fastener and, even if sheet or washer pull-over does not govern, pull-out strengths of this magnitude are not very common. This mode of failure will therefore hardly ever occur with these heavy-duty fasteners. The Ø 3.7 mm [0.145"] shank of an **X-HSN 24** or **X-EDNK22 THQ12** fastener may break at about 20 kN [4.5 kips] tension. Since these smaller fasteners will pull out at a force of 8 to 15 kN [1.8–3.3 kips], fractures due to tensile loads are rare. If fractured fasteners of this type are found on a jobsite, the most likely cause is that the application limit has been exceeded (the base steel is too hard and/or too thick for the pin).

Cyclic loading

Siding and decking nails used in wall and roof construction are subject to cyclic loading from wind suction. Cyclic load testing is carried out to determine characteristic resistance and allowable (recommended) loads. The approval requirements of the European Technical Approval ETA prepared by DIBt (Deutsches Institut für Bautechnik) govern the design-relevant number of load repetitions (5,000) and the necessary safety factors. Notes in this regard are found on the corresponding product data sheets.

If the fastener will be subjected to a large number of load repetitions and fatigue, we recommend carrying out a design check according to the requirements of Eurocode 3 (or similar

code). Eurocode 3 gives the characteristic fatigue resistance and safety concept for steel construction. To carry out the check according to Eurocode 3 it is necessary to have a statistical analysis of test data obtained under the application conditions. Except for siding and decking fasteners, the applicable product data sheets limit the validity of recommended loads to predominantly static loading. If a design analysis has to be carried out for true fatigue loading, test data can be obtained from Hilti. Examples of such data are shown below.

X-EM8-15-14

(standard zinc-plated fastener)

The X-EM8-15-14 has a shank diameter of 4.5 mm and a hardness of HRC 55.5 ($f_u = 2,000$ MPa). The ΔF -N diagram shows the load range ΔF for a lower load of 0.05 kN. The individual test results are displayed as points and the curves show average and characteristic (95% survival probability) values. The failure mode was shank fracture or fracture in the M8 threading.

The recommended load for predominantly static loading is 2.4 kN. Comparing this value to the ΔF -N diagram will lead to the conclusion that X-EM8-15-14 fastenings designed for 2.4 kN static loading will survive a large number of load repetitions. The fastenings can be said to be robust, even when the actual loading turns out to be in part cyclic.

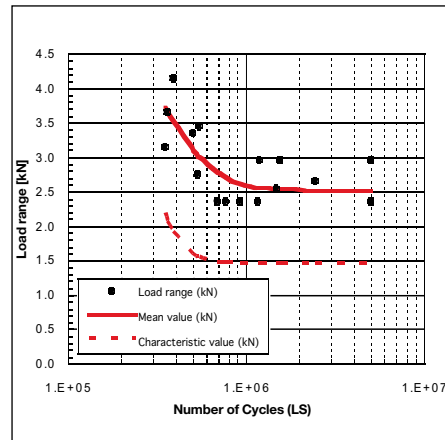

X-CRM8-15-12 (stainless steel fastener)

The X-CRM8-15-12 has a shank diameter of 4.0 mm and a minimum ultimate tensile strength of 1,850 MPa. The ΔF -N diagram shows the load range ΔF for a lower load of 0.05 kN. The individual test results are displayed as points. The failure mode was shank fracture or fracture just below the head of the stud.

The recommended load for predominantly static loading is 1.8 kN. Comparing this value to the ΔF -N diagram will lead to the conclusion that X-CRM8-15-12 fastenings designed for 1.8 kN static loading will survive a large number of load repetitions. The fastenings can be said to be robust, even when the actual loading turns out to be in part cyclic.

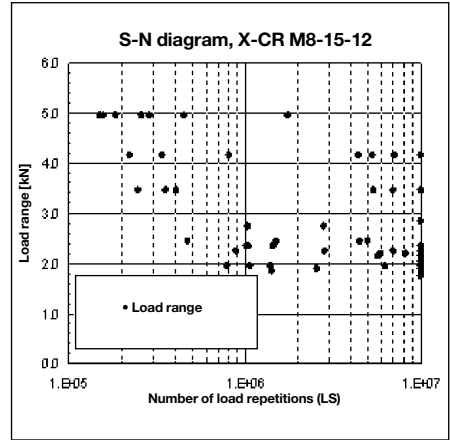

Mode of failure under cyclic loading

A major finding of cyclic loading tests is that the strength of a DX fastening subject to cyclic loading is not limited by failure of the anchorage. It is only when the number of cycles is very low – i.e. predominantly static loading – that nail pull-out is observed. The two schematic diagrams below show the relationship between failure mode and number of cycles. All tests show that the anchorage of DX fasteners in steel and in concrete is extremely robust with regard to resisting cyclic loading. Fasteners subject to a large number of load repetitions fracture in the shank, head or threading. A condition for obtaining this behaviour is that the fasteners are correctly driven. Fasteners that are not

driven deeply enough exhibit low pull-out strength and in a cyclic loading test may not necessarily fail by fracture.

Effect of number of cycles on failure mode
DX fastener in steel (correctly placed)

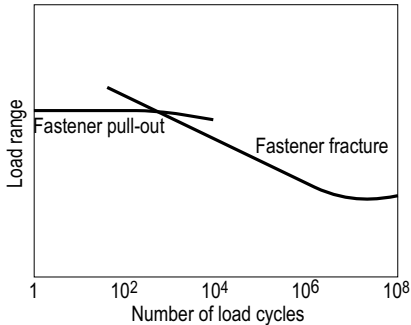

Effect of number of cycles on failure mode
DX fastener in steel (incorrectly placed)

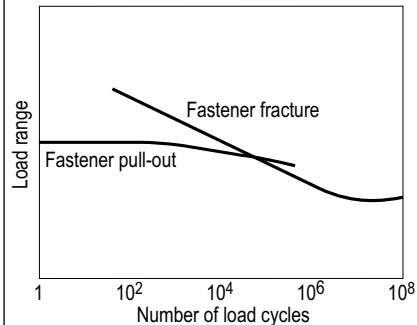

In older product information and data sheets, this basic suitability of DX fasteners for cyclic loading was emphasized by defining the recommended loads as cyclic recommended loads. At the time that this product information was assembled, a true safety concept for a strict check of DX fastenings subject to fatigue loading was not available. With Eurocode 3, this is today available. If a fatigue design analysis is carried out, it is important – as with static design – that adequate redundancy be provided.

Failure of the sheet

In cyclic load tests, failure of the steel sheet itself is common.

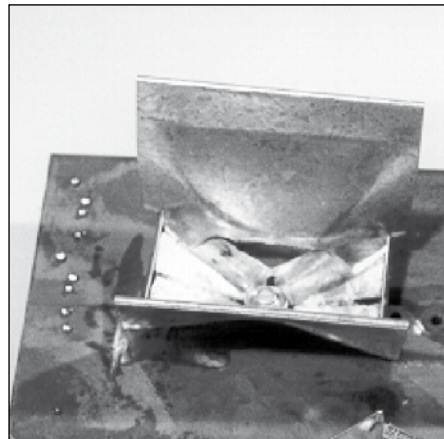

5.7 Effect of fasteners on structural steel

Driving powder- or gas-actuated fasteners into a steel member does not remove steel from the cross-section, but rather displaces steel within the cross-section. It is therefore not surprising that tests like those described in following sections show that both drilled holes and screws, either self-drilling or self-tapping, reduce the strength of a cross-section more than powder-actuated fasteners.

The results of the tests can also be used to show that it is conservative to consider a powder-actuated fastener as a hole. This allows the effect of fasteners in a steel member subject to static loading to be taken into consideration.

Fatigue seldom needs to be considered in building design because the load changes are usually minor in frequency and magnitude. Full design wind and earthquake loading is so infrequent that consideration of fatigue is not required. However, fatigue may have to be considered in the design of crane runways, machinery supports, etc. The S-N curves resulting from fatigue tests of steel specimens with fasteners installed are also presented.

5.7.1 Effect on the stress-strain behaviour of structural steel

The effect that powder-actuated fasteners (PAF's) have on the stress-strain behaviour of structural steel was investigated in a systematic test programme using tensile test specimens containing PAF's, self-drilling screws and drilled holes. A control test was carried out using specimens without any holes or fasteners.

Series A:

- ASTM 607, grade 50
- Cross-section 3.42 x 74 mm [0.135 x 2.913"]
- X-EDNK22 powder-actuated fasteners, shank diameter 3.7 mm [0.145"]
- Drilled holes, diameter 3.7 mm [0.145"]
- Self-drilling screws, shank diameter 5.5 mm [0.216"]

Series B:

- S235 and S355 steel
- Cross-section 6 x 45 mm [0.236 x 1.772"]
- Powder-actuated fasteners, shank diameter 4.5 mm [0.177"]
- Drilled holes, diameter 4.5 mm [0.177"]

The figures below show representative stress-strain curves for the tests (the plotted stress is based on the gross cross-section). Note that the line for the powder-actuated fasteners follows the control test line more closely than the lines for drilled holes or self-drilling screws.

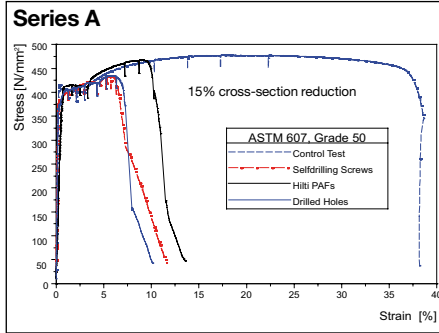

LOAD_DEFORMATION_SERIES_A

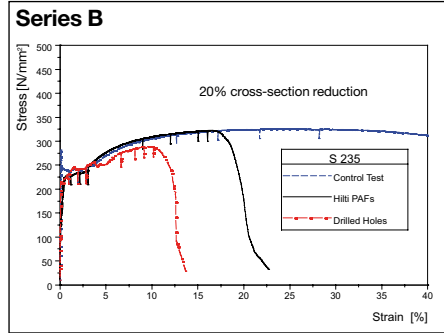

LOAD_DEFORMATION_SERIES_B

The test results were evaluated in terms of utilization as a measure of ultimate strength. Utilization is the ultimate load of a sample expressed as a percent of the ultimate load of the control test.

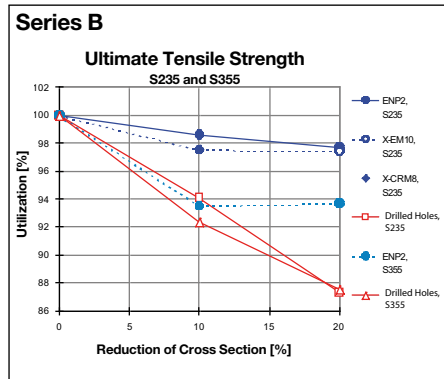
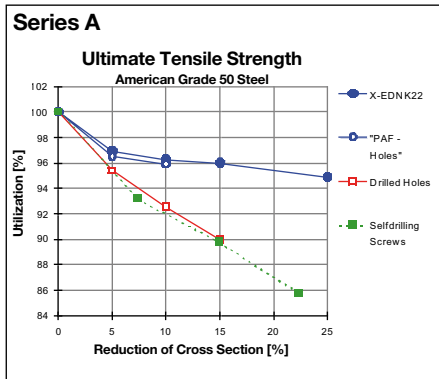

Graphs of the utilization versus cross-section reductions show that:

- The utilization for PAFs is clearly better than that of drilled holes or self-drilling screws.
- The hole left by a removed PAF has the same effect as when the PAF is left in place.
- Increasing the number of PAFs across a section from one to two or more has a proportionally smaller effect on utilization than placement of the first fastener.

More detailed information on the test program and findings is published in the paper **Powder-actuated fasteners in steel construction** (and the referenced literature), published in the STAHLBAU-Kalender 2011 (Publisher Ernst & Sohn, 2011, ISBN 978-3-433-02955-8). English Reprints of the paper can be distributed per request.

5.7.2 Effect on the fatigue strength of structural steel

During the late 1970s and early 1980s, a fatigue testing program consisting of 58 tests with over 1,100 specimens was carried out at the University of Darmstadt in Germany. The reason for the research at that time was to support the use of powder-actuated fasteners for attaching noise-dampening cladding to railway bridges in Germany.

Parameters investigated in those tests are shown in following table:

Steel grade	Steel thicknesses	Stress ratio R	Imperfections
S 235 (St 37) / A36	6, 10, 15, 20, 26.5, 40, 50 mm	0.8, 0.5, 0.14, -1.0, -3.0	Fastener:
S 355 (St 52) / grade 50	[0.236, 0.394, 0.591, 1.043, 1.575, 1.969 ⁴⁾]		- installed and pulled out, - inclined installation and pulled out - inclined installation

Loading conditions

The terminology and notation is shown in the illustration below.

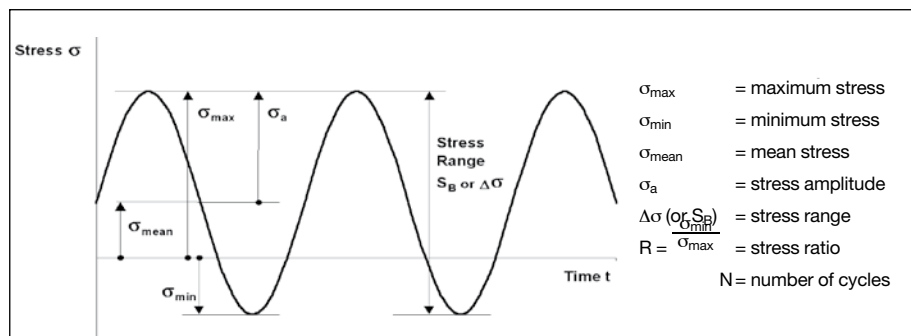

Fasteners tested

The primary fastener used in the tests was the Hilti ENP3-21 L15, the forerunner of the ENP2-21 L15. The difference is in the head shape, which has no effect on interaction with the base steel. Tests were also performed with the ENP2-21 L15, ENP3-21 D12 and the EM8-11-14 threaded stud, all of which have 4.5 mm diameter knurled shanks.

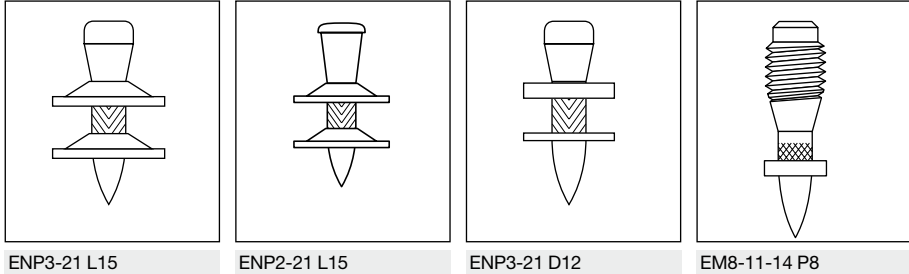

The results of the tests were evaluated by Niessner and Prof. T. Seeger from the University of Darmstadt in accordance with the provisions of Eurocode 3. An example plot of one test series is given at the right. The graph allows for a comparison with European fatigue categories 90 ($m = 3$) and 100 ($m = 5$) as well as American categories according to AWS-provisions.

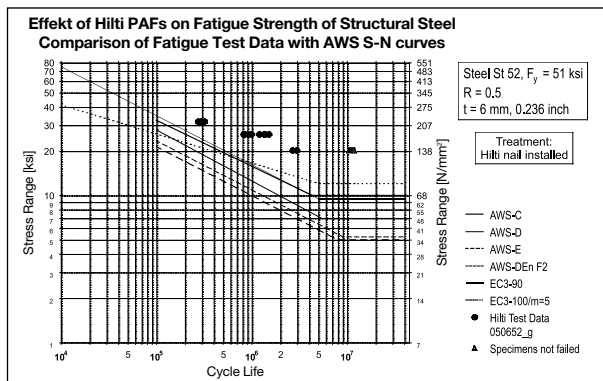

Conclusions

- The effect of driving a Hilti powder-actuated fastener on the fatigue strength is well known and predictable.
- The constructional detail “Effect of powder-actuated fasteners on base material” (unalloyed carbon steel) was evaluated by Niessner and Seeger from the University of Darmstadt in compliance with Eurocode 3.
- The EC 3 detail category 90 with $m = 3$ or the detail category 100 with $m = 5$ is alternatively applicable.
- Wrong fastener installations as popped out or inclined fasteners are covered. Piston marks in the base material due to wrong use of the tool without a fastener or notches due to fasteners failed during the installation have to be removed by appropriate measures.

More detailed information on the evaluation of the test data and the test program is published in the paper "Fatigue strength of structural steel with powder-actuated fasteners according to Eurocode 3" by Niessner M. and Seeger T. (Stahlbau 68, 1999, issue 11, pp. 941-948).

English reprints of this paper can be distributed per request.

6. Concrete base material

6.1 Anchoring mechanisms

The following three mechanisms cause a DX-/GX-fastener to hold in concrete:

- Bonding / sintering
- Keying
- Clamping

These mechanisms have been identified and studied by analyzing pull-out test data and by microscopic examination of pulled-out fasteners and the concrete to fastener interface.

Bonding / sintering

When driving a fastener into concrete, the concrete is compacted. The intense heat generated during driving causes concrete to be **sintered** onto the fastener. The strength of this sintered bond is actually greater than that of the **clamping** effect due to reactive forces of the concrete on the fastener.

The existence of the sintered bond is demonstrated by examining pulled-out fasteners. The fastener surface, especially in the region of the point, is rough due to sintered-on concrete, which can only be removed by using a grinding tool.

When performing pull-out tests, the most common failure mode is breakage of the sintered bond between the concrete and the fastener, especially at and near the point.



Keying

The sintered material forms ridges on the fastener surface. These ridges result in a micro-interlocking of the fastener and the concrete.

This anchoring mechanism is studied by examining pulled-out fasteners under a microscope. As in the case of sintering, keying is primarily active in the region of the fastener point.

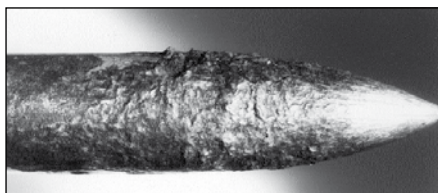

Mechanically cleaned point of a pulled-out DX fastener

Clamping

The compressibility of concrete limits the buildup of compressive stress around the driven fastener. This in turn limits the effectiveness of clamping as an anchoring mechanism.

The tendency of stressed concrete to relax further reduces the compressive stress and hence the clamping effect. For these reasons, clamping of the fastener shank contributes only insignificantly to the total pull-out strength.

Concrete failure

Concrete cone failure is occasionally observed when using a testing device with widely spaced supports. The fact that the concrete failed indicates that the fastener bond to the concrete was stronger than the concrete.

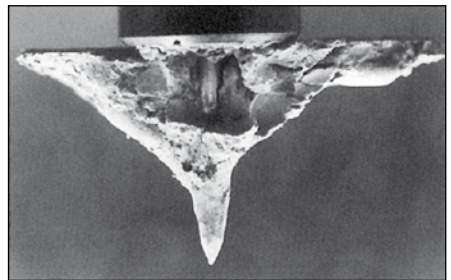

6.2 Factors influencing resistance to pull-out

Factors that can affect the pull-out strength of fastenings to concrete include:

- Depth of penetration into the concrete
- Concrete parameter (compressive strength, grain structure, direction of concrete placement)
- Distance to concrete edge and fastener spacing

Depth of penetration h_{ET}

Fasteners that are driven deeper typically have a higher resistance to pull-out. This relation is best shown by placing groups of fasteners with different driving energy and comparing the results for each group with the others. The result of such a test is shown in the graph at the right. Note that fastener driving failures were not considered in calculation of the average ultimate load, $N_{u,m}$.

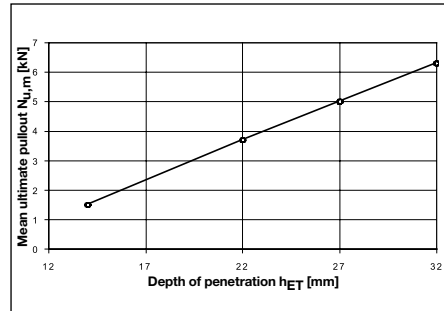

The value of increasing the depth of penetration in order to increase pull-out strength is limited by the increasing fastener driving failure rate. Provided that the penetration depth is the same, fastenings in concrete with a higher compressive strength hold better than fastenings in lower strength con-

crete. The ability to exploit this characteristic is also limited by increased fastener driving failure rate with higher strength concrete. As could be expected, the depth of penetration at which the failure rate is at a minimum decreases with increasing concrete strength.

Pull-out strength and fastener driving failure rate both increase with increasing penetration depth. The optimum depth of penetration is taken as the depth at which the yield in terms of pull-out strength begins to decrease. This is within a range of 18–32 mm depending on the grade and age of the concrete as well as the strength of the fastener.

$$\text{yield} = N_{u,m} \cdot \left(\frac{100 - p}{100} \right)$$

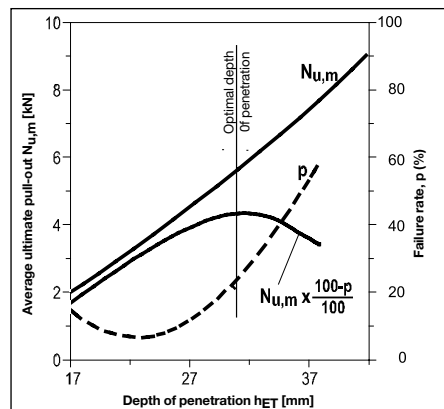

Concrete parameters

The concrete parameters (such as the type and size of concrete aggregates, type of cement and the location on top or bottom surface of a concrete floor) do affect the fastener driving failure rate, sometimes significantly.

Fastener driving failures are caused by the fastener hitting a hard aggregate, such as granite, located close to the concrete surface. A hard aggregate can deflect the fastener and in a severe case, the fastener may bend excessively, lead-

ing to concrete fracture in a cone shape and no hold being obtained by the fastener.

In case of slight fastener bending, concrete spalling may occur at the surface. However, because pull-out strength is obtained mostly in the area of the fastener point, concrete spalling does not affect the permissible load of the DX-/GX-fastening.

Softer aggregates such as limestone, sandstone or marble may be completely penetrated when hit by the fastener.

Overhead fastening is usually associated with a higher rate of fastener driving failure than floor fastening. This is due to the distribution of the aggregates within the concrete. Large aggregates tend to accumulate at the bottom of a floor slab. At the top, there is a greater concentration of small aggregates and fines.

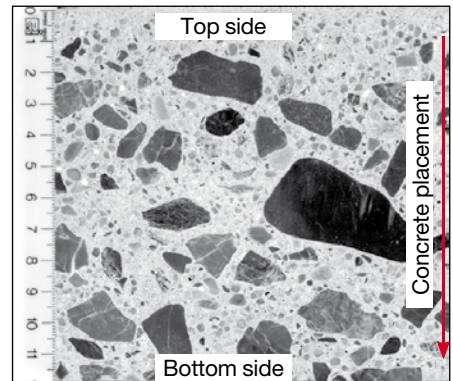

There are several possible ways of reducing the failure rate when powder-actuated fasteners are used for fastening to concrete. There are two basic ideas: one is to

reduce concrete tensile stresses near the surface and the other is to delay the effect of these stresses.

Pre-drilling the concrete (DX-Kwik)

By pre-drilling a very small hole (5mm diameter, 18 or 23 mm deep), the stresses are relocated to greater depth in the concrete. Fasteners placed with DX-Kwik are surrounded by a stress “bulb” located deep in the concrete. With this method, virtually no fastener driving failures occur.

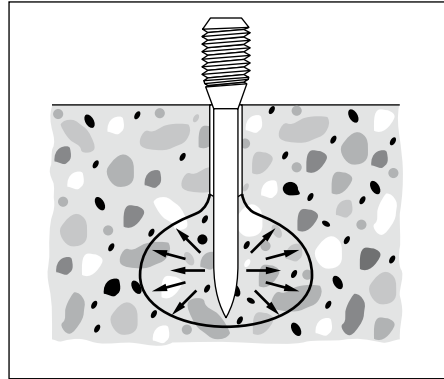

Spall stop fastener guide

A spall stop is a heavy steel fastener guide. Its weight and inertia counteract the stresses at the surface for a very short time. This allows redistribution of the stresses to other parts of the concrete.

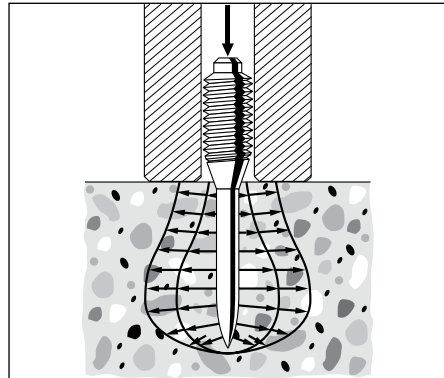

Changing from a long to a short fastener reduces the magnitude of the stresses and thus the rate of fastener driving failure.

Edge distance and fastener spacing

If fasteners are placed too close to the concrete edge, pull-out load capacity will be reduced. Minimum edge distances are therefore published with a view to reducing the effect edges have on pull-out strength. The corresponding data has been obtained from tests and analysis and is given in part 2 of this manual.

Additional provision is made for fastener spacing when positioned in pairs or where fasteners are placed in rows along a concrete edge.

These edge distances and spacing also have the purpose of helping to prevent concrete spalling and/or cracking due to fastening. However, spalling has generally only an insignificant influence on pull-out strength.

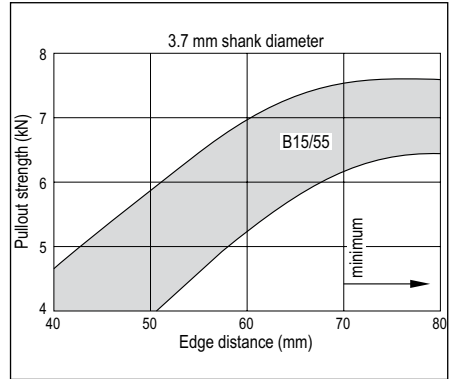

6.3 Effect of time on pull-out resistance

The effect of age on pull-out strength has been investigated in comprehensive tests. The main concern is, in fact, the effect of concrete relaxation in the area around the driven fastener.

This graph provides an overview of tests performed with DX-Kwik fasteners. Since standard DX fastenings have the same anchoring mechanism, this statement is also valid for standard DX fastenings. The test results indicate very strongly that relaxation of the concrete has no detrimental effect on the pull-out resistance of DX fastenings. The test data also shows that sintering and keying are the dominant anchorage mechanisms because they do not rely on friction between the fastener and the concrete.

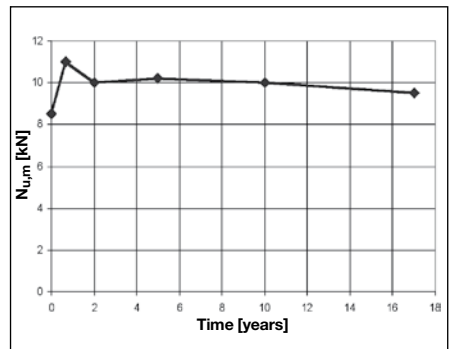

6.4 Effect on concrete components

Fastenings in the compression zone of the structure have no effect on concrete compressive resistance as long as detailed provisions on edge distance and spacing are complied with.

Fastenings in the **tensile zone** are subject to the following provisions:

a. **Installations on plain load-bearing components such as concrete walls or ceilings are generally possible without restrictions** as the load-bearing behaviour of these components is only negligibly affected by the fasteners. The predominant condition is static loading. This statement is based on experimental investigations carried out at the Technical University of Braunschweig, Germany.

If the concrete is too thin, concrete will spall off on the rear surface. The minimum thickness of concrete depends on the shank diameter of the fastener used.

- b. Fastenings in reinforced concrete beams: it has to be ensured that the main reinforcement steel will not be hit or penetrated by the DX fasteners. This measure of precaution is mainly founded on the reduction of the ultimate strain of the steel reinforcement. Exceptions are possible when the structural engineer responsible for design is consulted.
- c. Fastenings in pre-stressed concrete members: it has to be ensured that the pre-stressing steel reinforcement or cables will not be hit or penetrated by the DX fasteners.

Fastener shank diameter d_{nom} (mm)	Minimum concrete thickness h_{min} (mm)
3.0	60
3.5 / 3.7	80
4.5	100
5.2	100

7. Masonry base material

7.1 General suitability

Direct fastening technology can also be used on masonry. The joints between bricks or blocks and the covering plaster layer on virtually all types of masonry (exception for

lightweight aerated concrete blocks) provide an excellent substrate for light-duty and secondary fastenings.

Suitability table: DX fastening on masonry

Masonry material	Unplastered masonry Fastenings in mortar joints* (joint width ≥ 10 mm)	Fastenings in masonry blocks or bricks	Plastered masonry Fastening in plaster (thickness ≥ 20 mm)
Clay brick			
solid	++	+	++
vertical perforated	++	—	++
horizontally perforated	++	—	++
Clay clinker			
solid	++	+	++
vertical perforated	++	—	++
Sand-lime block			
solid	++	++	++
perforated	++	++	++
hollow	++	++	++
Aerated concrete	—	—	—
Lightweight concrete			
solid	++	—	++
hollow	++	—	++
Hollow concrete	++	+	++
Slag aggregate			
solid	++	—	—
perforated	++	—	++
hollow	++	—	++

++ suitable

+ limited suitability

— not fully investigated

— not suitable

*) Joints must be completely filled with mortar

The above table is based on laboratory and field experience. Because of the wide variety of types and forms of masonry in use worldwide, users are advised to carry out tests on site or on masonry of the type and form on which the fastenings are to be made.

8. Temperature effects on the fastening

8.1 Effect of low temperatures on fasteners

Steel tends to become more brittle with decreasing temperature. Increased development of natural resources in Arctic regions has led to the introduction of steels that are less susceptible to brittle failure at subzero temperatures. Most siding and decking fasteners are used to fasten the liner sheets of an insulated structure and are not exposed to extremely low tempera-

tures during service. Examples of situations where the fastenings are exposed to extremely low temperatures during their service life are:

- Fastenings securing cladding in single-skin construction
- Construction sites left unfinished over a winter
- Liner sheets in a cold-storage warehouse

Low temperature embrittlement

The susceptibility of fasteners to become brittle at low temperatures can be shown by conducting impact bending tests over a chosen temperature range. The ability

of Hilti drive pins to remain ductile over a temperature range from +20°C to -60°C is shown clearly by the fact that the impact energy required remains nearly constant throughout this temperature range.

Impact bending test - DSH57 (4.5 mm diameter, HRC 58 ± 1)

Temperature		Impact energy (foot-pounds)			Impact energy (Joules)		
°F	°C	minimum	maximum	mean	minimum	maximum	mean
68	20	35.1	>36.1	>36.1	47.6	>48.9	>48.9
32	0	35.8	>36.1	36.0	48.5	>48.9	48.8
- 4	-20	31.4	>36.1	34.3	42.6	>48.9	46.5
-40	-40	34.4	36.5	35.7	46.6	49.4	48.4
-76	-60	35.6	36.2	35.9	48.2	49.0	48.7

Impact bending test - X-CR (4.0 mm diameter)

Temperature		Impact energy (foot-pounds)			Impact energy (Joules)		
°F	°C	minimum	maximum	mean	minimum	maximum	mean
68	20	14.8	17.0	15.9	20	23	21.6
32	0	17.7	15.5	18.3	24	21	24.8
- 4	-20	14.8	15.9	15.5	20	21.6	21.0
-40	-40	16.2	17.9	16.8	21.9	24.2	22.8
-76	-60	14.2	15.6	15.1	19.2	21.1	20.5

Impact bending test - X-CR (3.7 mm diameter)

Temperature		Impact energy (foot-pounds)			Impact energy (Joules)		
°F	°C	minimum	maximum	mean	minimum	maximum	mean
68	20	11.5	14.8	13.2	15.6	20.0	17.9
32	0	12.9	16.3	15.1	17.5	22.1	20.4
- 4	-20	13.1	15.8	14.7	17.8	21.4	19.9
-40	-40	14.2	15.8	14.8	19.2	21.4	20.1
-76	-60	12.3	15.0	13.7	16.7	20.3	18.6

Tests conducted according to DIN EN 10045 parts 1-4

Distance between supports = 22 mm

The symbol ">" indicates no breakage of the specimens. In the other cases, about 50% of the specimens suffered breakage.

8.2 Effect of low temperatures on fastenings to steel

Effect of low temperatures on pull-out strength

Tests show that very low temperatures tend to increase pull-out strength with both standard zinc-plated fasteners and with the stainless steel. The results of two tests are summarized below. The fasteners were driv-

en at room temperature and tested at -40°C to -70°C. A control sample was tested at 20°C. Explanations for the greater strength at low temperatures include increase in the strength of the zinc that is displaced into the knurling as well as increased strength of the fusing at the point of the fastener.

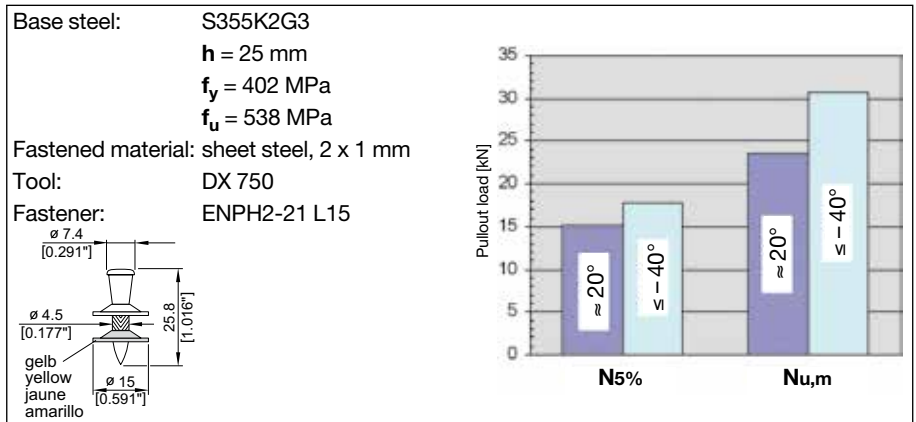

Base steel : $h = 20 \text{ mm}$
 $f_u = 450 \text{ MPa}$
 Fastened material : none
 Tool : DX 750 G
 Fastener : X-CRM8-15-12 FP10

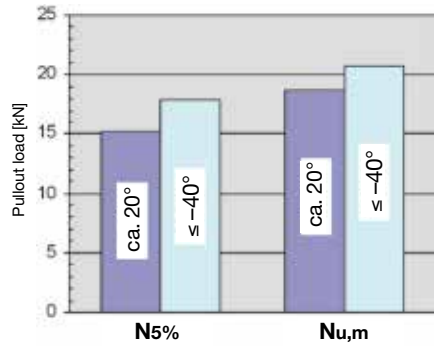
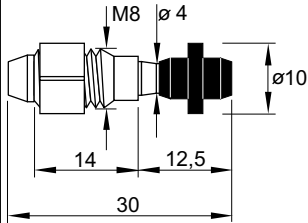

Two facts stand out from this testing:

- Pull-out strength increased as temperature decreased
- Pull-out from the base steel was the only mode of failure observed. There were no fractures!

8.3 Fire rating of fastenings to steel

Standard zinc-plated, thermally hardened steel fasteners

When subjected to high temperatures as in a fire, both powder-actuated fasteners

and structural steel lose strength. Data for standard zinc-plated, thermally hardened fasteners and structural steel are plotted in the graph below.

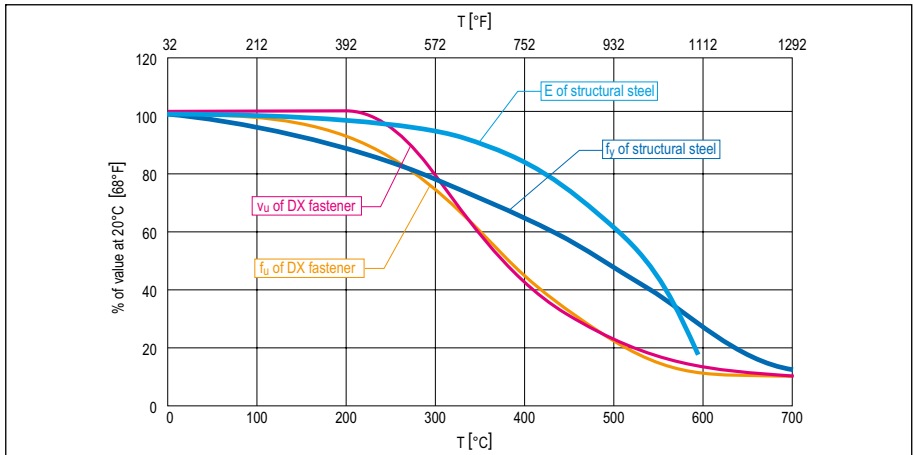

Up to about 300°C [572°F], the strength loss for DX fasteners is roughly proportional to the yield strength loss of structural steel. At 600°C [1112°F], DX fasteners have about 12% of their 20°C [68°F] strength left and structural steel about 26%. Since DX fasteners obtain their high strength through a thermal hardening process, the loss in strength at elevated temperatures is proportionally greater than for structural steel.

The relevance of different strength losses has to be evaluated in the context of the proportion of the material strengths that are actually exploited in a design. In a design calculation, it is conceivable that some steel will actually reach yield stress.

The material strengths of an X-ENP-19 L15

fastener is 30 kN [6.74 kips] in tension and 18.6 kN [4.18 kips] in shear respectively. The recommended working load in tension and shear for an X-ENP-19 L15 16 gauge (1.5 mm) fastening is 4.7 kN [1.057 kips] in tension and 4.6 kN [1.034 kips] in shear, respectively. Thus, the exploitation of the X-ENP-19 L15 strength at about 600°C is only 16 to 25% compared to about 74% for structural steel.

In a fire, powder-actuated fastenings will not be the governing factor. If the fire protection requirements permit the use of structural steel, then powder-actuated fastening can also be used without negative impact on fire protection.

CR500 stainless steel fasteners

Hilti X-CR/X-CRM fasteners are much more resistant to loss of strength at high temperatures than standard fasteners. The effect of temperature on ultimate shear stress of X-CR/X-CRM/X-BT fasteners was determined in single lap joint shear tests by the

Swiss Federal Laboratory for Materials Testing and Research (EMPA). The results are plotted in the diagram below. This test was done by shearing 4.5 mm diameter fasteners that were inserted in steel plates with 4.6 mm diameter drilled holes.

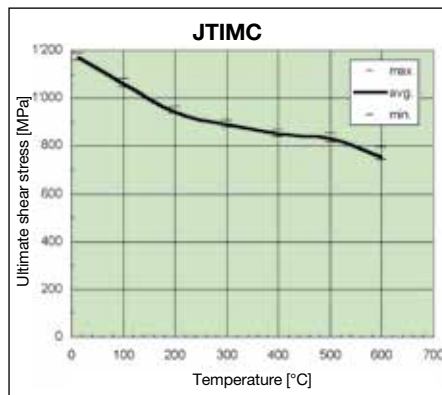
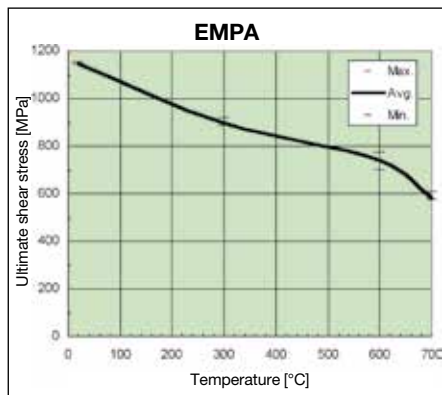

In Japan, similar tests were carried out by JTICM (Japan). These tests were done by driving a 4.5 mm diameter X-CR nail through a 6 mm steel plate into a second 6 mm thick steel plate and shearing the two plates. From the graph it is apparent that the results are nearly the same.

At 600°C, the CR500 material has 64% of its 20°C shear strength left. By comparison, standard fasteners have only 12% and structural steel only about 26%. The excellent fire resistance of the CR500 material alone justifies its use for some applications.

8.4 Fire rating of fastenings to concrete

Concrete is weakened and damaged by fire but not as quickly as steel. In ISO-standard fire tests conducted with DX-Kwik fastenings at the Braunschweig Technical University in Germany the only failure mode was fracture of the nails.

The actual test data are shown in the table below:

X-DKH 48 P8S15 DX-Kwik fastener, 4.0 shank

Tested in crack width ΔW (mm)	Tensile load, F (N)	Fire resistance/ time to failure (minutes)	Failure mode
0.2	250	103	Nail fracture
0.2	250	107	Nail fracture
0.2	350	73	Nail fracture
0.2	350	91	Nail fracture
0.2	500	56	Washer pullover
0.2	500	92	Nail fracture
0.2	500	93	Nail fracture

The stress in the fasteners at failure was calculated and plotted so that a plot of stress versus time resulted.

The characteristic failure stress curve from the previous graph can be used to calculate the failure load for various shank diameters with exposure to fire of different lengths of time. The calculated failure loads for 3.7, 4.0 and 4.5 mm shank diameter fasteners after 60, 90 and 120 minutes exposure to fire are shown in the table below.

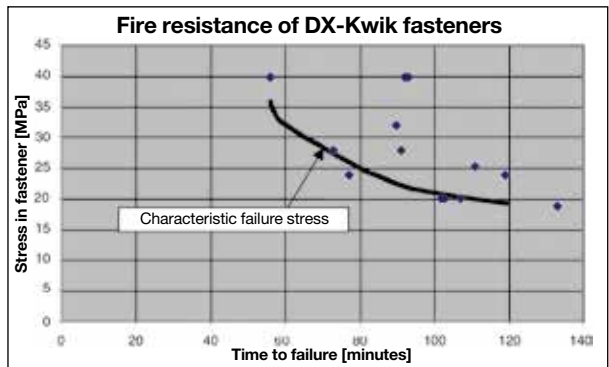

Failure loads for various shank diameters and fire exposure times

Shank diameter (mm)	Fire exposure time and failure stress		
	60 minutes	90 minutes	120 minutes
	32.1 MPa	22.3 MPa	19.1 MPa
3.7	340 N	240 N	200 N
4.0	400 N	280 N	240 N
4.5	510 N	350 N	300 N

This table can be used to determine recommended loads for the ISO fire resistance required.

9. Design concepts

The recommended working loads **N_{rec}** and **V_{rec}** are suitable for use in typical working load designs. If a partial factor of safety design method is to be used, the **N_{rec}** and **V_{rec}** values are conservative when used as **N_{Rd}** and **V_{Rd}**. Alternatively, the design resistance may be calculated from the recommended loads by multiplying by the factor 1.4, which considers the uncertainties from the load on the fasteners. Exact

values for **N_{Rd}** and **V_{Rd}** can be determined by using the safety factors where given and or reviewing test data. Based on cyclic tests it can be stated that DX fastenings can be said to be robust, even when the actual loading turns out to be in part cyclic. Design loads (characteristic strength, design resistance and working loads) for the **X-HVB** shear connector are listed and specified per design guideline.

The designer may encounter two main fastening design concepts:

Working load concept

$$N_S \leq N_{rec} = \frac{N_{Rk}}{\gamma_{GLOB}}$$

where γ_{GLOB} is an overall factor of safety including allowance for:

- errors in estimation of load
- deviations in material and workmanship

and **N_S** is in general a characteristic acting load.

$$N_S \equiv N_{Sk}$$

Partial factors of safety

$$N_{Sk} \cdot \gamma_F = N_{Sd} \leq \frac{N_{Rk}}{\gamma_M} = N_{Rd}$$

where:

γ_F is a partial factor of safety to allow for errors in estimation on the acting load and

γ_M is a partial factor of safety to allow for deviations in material and workmanship.

The characteristic strength is defined as 5 % fractile:

$$N_{Rk} = N_{u,m} - k \cdot s$$

The k factor is a function of the sample size and the accuracy required. The characteristic strength of fastenings to concrete is determined based on a 90% probability while fastenings to steel are based on a 75% probability.

Structural analysis of the fastened part (e.g. roof deck panel or pipe hung from a number of fastenings) leads to calculation of the load acting on a single fastening, which is then compared to the recommended load

(or design value of the resistance) for the fastener. In spite of this single-point design concept, it is necessary to ensure adequate redundancy so that failure of a single fastening will not lead to collapse of the entire system. The old saying “one bolt is no bolt” can also be applied to DX fastening.

For standard DX fastenings on concrete, a **probability-based design** concept based on multiple fastening is applied in order to allow for fastener driving failures and the large scatter in holding power observed. This concept applies to tensile as well as shear loading and is described in following chapter.

10. Determination of technical data for fastening design

The determination of technical data is based on the following tests:

- Application limits
- Tensile tests to determine pull-out and pull-over strength
- Shear tests to determine bearing capacity of the attached material and the base material.

These tests are described in more detail in the sections “Steel and other metal base material” and “Concrete base material”.

10.1 Fastenings to steel

Failure loads in tension and in shear are normally distributed and the variation coefficient is $<20\%$. The test data for each test condition are evaluated for the average and characteristic values. The characteristic value is based on the 5% fractile for a 75% probability.

The application range of the fastener is determined by application limit test where fasteners are set on steel plates of thickness ranging from the minimum recommended thickness $t_{II,min}$ to full steel (≥ 20 mm) and varied plate strength.

The application limit is reached when 1 shear off failure with 30 fasteners tested occurs, or if a detrimental effect on the load values (resistance) occurs, or if a detrimental effect on the load values (resistance) occurs.

Due to the small scatter in failure loads fastenings in steel can thus be designed as single points, although good engineering practice should be kept in mind. System redundancy must be always ensured.

10.2 Profile sheet fastenings

In addition to general fastenings to steel, specific data applies to profile sheet fastenings:

Cyclic loading

Profile sheet fastenings are subjected to repeated loading to simulate wind effects. Cyclic pull-through tests are additional optional tests where the failure load at 5,000 cycles is determined.

The design value of the pull-through resistance for repeated wind loads is the design value of the static pull-through resistance multiplied by a reduction factor of α_{cycl} .

- If cyclic tests are carried out:

$$\alpha_{cycl} = 1.5 (N_{Rk,cycl.} / N_{Rk,sta}) \leq 1$$

(The factor 1.5 takes the different safety levels for fatigue and predominately static design into account)

- If no cyclic tests are carried out:

$$\alpha_{cycl} = 0.5$$

Sheet bearing capacity

Profile sheet fastenings may be subjected to shear stresses from building movements or thermal dilatation of the sheets. Tests are undertaken to prove the suitability of the fastenings to support the deformations imposed.

For this, shear tests are carried out using a substrate of the minimum and maximum thickness and 2 layers of profile sheet of the thickness specified.

The fastening is considered suitable if an elongation of 2 mm is achieved without the sheet coming loose or showing an excessive reduction in pull-out load capacity. In this case, no consideration of forces of constraint is required since sufficient ductility is provided by the fastening due to hole elongation.

Standardization

The pull-over strength of profiled sheet fastenings is given with reference to core sheet thickness. Ultimate load data is standardized to the minimum sheet thickness and strength as specified by the relevant sheet standard. The correction applied is as follows:

$$F_{u'} = F_u \cdot \frac{t_{min}}{t_{act}} \cdot \frac{f_{u,min}}{f_{u,act}}$$

10.3 Fastenings to concrete (standard DX / GX)

The failure loads in tension and shear show a large scatter with a variation coefficient of up to 60%. For specific applications, fastener driving failures may be detected and the fasteners replaced (e.g. threaded studs). For others, however, detection may not be possible (e.g. when fastening wooden battens) and this must be taken into consideration.

The design resistance is therefore determined for:

- failure loads without considering fastener driving failures
- failure loads considering a 20% rate of fastener driving failure

Evaluation of technical data and design according to the single point design approach based on fractiles and a safety factor is not feasible for such systems. The characteristic value would become zero at a variation coefficient of about 50%.

The evaluation of the data and the determination of the design resistance is therefore based on a multiple fastening, i.e. a redundant design, in which the failure probability not of a single, but of a number of fasteners supporting a structure is calculated. By this system, load may be transferred between the fasteners, if slip or failure or more of one of the fasteners occurs.

Test data

The test data for the fastener is consolidated to form a master pullout load distribution.

Static system

Two static systems are examined

- A suspended beam allowing unrestrained flexure of the beam
- A beam directly attached to the surface, which shows restrained flexure

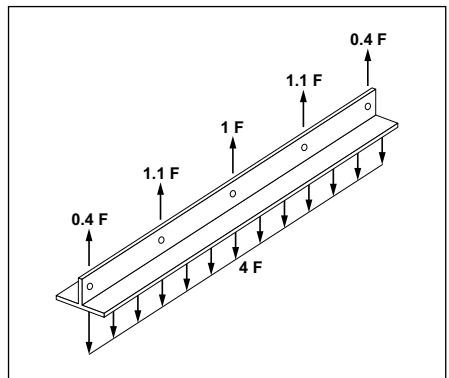

Calculation method

The calculation method used is the Monte Carlo method, by which holding values taken stochastically from the master distribution are attributed to the individual fasteners of the system and the system is checked to determine whether the imposed line load can be supported. By performing a large number of such simulations, statistical information on the failure probability of a system under a given line load is obtained.

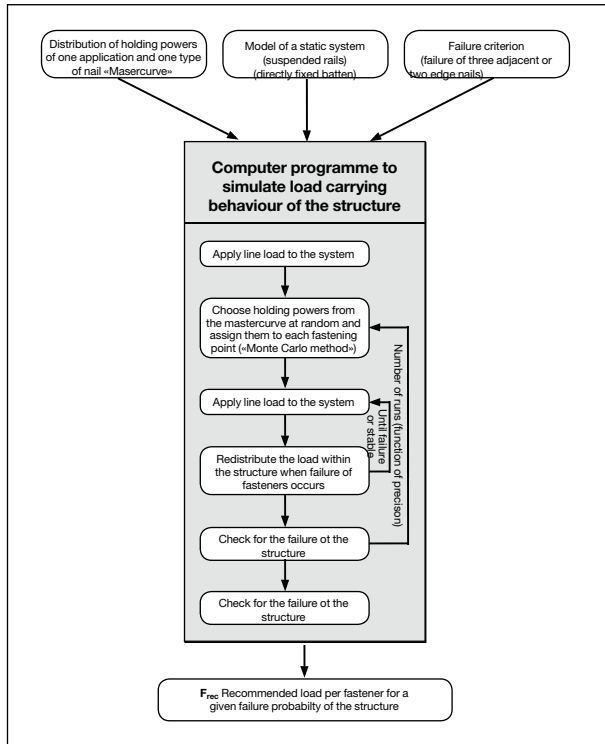

Design parameters

The design is based on the following parameters:

- Failure probability: $1 \cdot 10^{-6}$
- Number of fasteners: 5
- Line load uniformly distributed
- Failure criterion: 2 edge or 3 central fastenings

The result is expressed in **recommended load per fastening**.

Effect on a fastening design

The overall condition for a fastening design in practice is that redundancy of the complete system has to be ensured. The effect of the Monte Carlo approach on a design is illustrated with two examples below.

Example:

Fastening of a plumbing with five ceiling hangers.

1. Due to the stiffness (EI) of the plumbing a redistribution of the dead load (g) to the remaining hangers is given in case of two neighbouring hangers failing.

(Fixing of each hanger with one nail is sufficient.

2. The plumbing is not stiff enough to redistribute the dead load to the neighbouring hangers in case of one fastener failing.

(Each hanger has to be fastened with five nails.

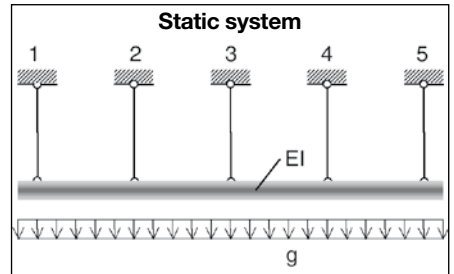

10.4 DX fastenings to concrete (DX-Kwik)

Failure loads in tension and shear are log-normally distributed and the variation coefficient is <20%. The test data is evaluated to yield the 5% fractile based on a 90% probability. The recommended working loads are obtained by applying a global safety factor of 3 for tension and shear.

The determination of technical data for cracked concrete (tensile zone) is based on tensile tests. Shear tests in cracked and uncracked concrete give similar results and are therefore not performed.

Failure loads in cracked concrete show a higher variation coefficient. Test data is also evaluated to yield the 5% fractile. The recommended load for the tensile zone is taken as the smaller of the following values:

- $N_{rec} = N_{RK} / \gamma_{GLOB}$ $\gamma_{GLOB} = 3.0$ for 0.2 mm crack width
- $N_{rec} = N_{RK} / \gamma_{GLOB}$ $\gamma_{GLOB} = 1.5$ for 0.4 mm crack width.

The application range of the fastener is determined by application limit test where fastenings are made on concrete of varying strength and age according to the application conditions specified (pre-drilling and setting). The attachment height is kept at the lower end of the range specified. The application limit is reached, if the failure rate exceeds 3% or the pull-out values strongly deviate from a lognormal distribution. The sample size is 30 per condition.

10.5 Fastener design in the USA and Canada

Testing of powder-actuated fasteners is carried out according to the ICC-ES AC 70 acceptance criteria and ASTM E 1190 standard test method. The test procedure covers tensile and shear testing in steel, concrete and masonry.

The determination of the allowable (recommended) load is shown below. The recommended working load is derived from the test data by taking the average failure load or the calculated characteristic load divided by a global safety factor.

Three different options have to be distinguished:

COV ≥ 15%		COV < 15%
based on characteristic load N = 30 tests	based on lowest ultimate load N = 10 tests	based on mean ultimate load N = 10 tests
$F_{rec} = \frac{F_{u,m} - 2s}{v} = F_{u,m} \frac{1 - 2COV}{v}$	$F_{rec} = \frac{\min F_u}{v}$	$F_{rec} = \frac{F_{u,m}}{v}$

with a safety factor of $v = 3.5$	with a safety factor of $v = 5$
-----------------------------------	---------------------------------

where:

- F_{rec} = allowable (recommended) load
- $COV = s/F_{u,m}$ = coefficient of variation in a test series
- s = standard deviation in a test series
- $F_{u,m}$ = average ultimate load in test series

Approvals → Nails

Approval	Segment	Product	Country	Application
ABS 01-HS156800A/3-PDA	PS	EDS, X-U, X-ENP2K, X-ENP-19, X-EDN, X-EDNK, X-EM, X-EW, X-EF, X-FCM	Int.	Fastenings to steel
ABS 01-HS156800B/2-PDA	PS	X-CR, X-CRM, X-CRW, X-FCM-R, X-FCM-M, X-FCP-R, X-FCP-F	Int.	Fastenings to steel
ABS 03-HS 369456/3-PDA	PS	X-BT, X-FCM-R(M)	Int.	Fastenings to steel, Off-Shore, Shipbuilding
BRANZ Appraisal 780 (2012)		Wood nails	NZ	Timber joints
BUTgb ATG 13/1824	SM	NPH2, X-ENP2K	B	Metal Deck
BV 23498/A1	PS	X-BT, X-FCM-R(M)	Int.	Fastenings to steel, Shipbuilding
Canadian Navy	PS	X-BT	Can	Fastenings to steel, Shipbuilding
COLA RR 25296	SM	X-ENP, X-EDN19, X-EDNK22	USA	Metal Deck
COLA RR 25646	BC	X-EDNI, EW6, EDS, EW10, X-DNI, DS, ESD, X-C, X-CR, X-ALH, W6, W10	USA	Fastenings to steel and concrete
COLA RR 25651	IF	X-CC27 C27/32, U22/27, ALH22/27	USA	Ceiling Hanger
COLA RR 25662	IF	X-GN, X-EGN, X-DAK, X-DW, X-ZF, X-S	USA	Dry-wall
COLA RR 25675	BC	X-U, X-U15	USA	Fastenings to steel and concrete
COLA RR 25684	ME	X-EW6H, X-EM8H, X-EW10H, X-CRM8, X-BT	USA	Fastenings to steel
COLA RR 25708	BC	X-DNI72, X-ZF72, X-CF72, X-CP72, X-CR-L72	USA	Sill plate
COLA RR 25826	ME	X-HS U19/27/32	USA	Ceiling hanger
COLA RR 25839	IF	X-CW	USA	Ceiling hanger
COLA RR 25877	SM	X-ENP-19, X-EDN-19, X-EDNK22	USA	Metal Deck
COLA RR 25921	IF	X-GPN	USA	Plywood
CSTB AT 3/09-639	ME	X-EKB, X-ECH, X-ECT, X-EKS, X-EKSC, X-CC, X-HS, X-HS-W	F	Electrical fastenings
CSTB AT 5/03-1943	SM	X-ENP2K	F	Metal Deck
DIBt Z-14.4-456	SM	X-CR14	D	Glas facade
DIBt Z-14.4-517	BC	X-U	D	Fastenings to steel
DIBt Z-21.7-1512	SM	X-CR M8, X-CR48 (DX-Kwik)	D	Facade
DIBt Z-21.7-670	IF	M8H, X-CR M8, X-DKH48, X-CR48 (DX-Kwik)	D	Ceiling Hanger
DIBt Z-26.4-46	SM	X-HVB	D	Shear Connection
DIN EN 1993-1-3/NA	SM	X-ENP-19 Lateral buckling	D	Metal Deck
DNV	PS	X-BT, X-FCM-R(M)	Int.	Fastenings to steel, Grating
ETA-03/0004-English	BC	XI-FV	EEA	ETICS
ETA 03/0004-French	BC	XI-FV	EEA	ETICS
ETA-03/0004-German	BC	XI-FV	EEA	ETICS
ETA-04/0101-English	SM	X-ENP-19	EEA	Metal Deck
ETA-04/0101-French	SM	X-ENP-19	EEA	Metal Deck
ETA-04/0101-German	SM	X-ENP-19	EEA	Metal Deck
ETA-04/0101-Romanian	SM	X-ENP-19	EEA	Metal Deck
FM	ME	W10, EW10	USA	Sprinkler
FM 0W8A6.AM	SM	X-EDN-19, X-EDNK-22	USA	Metal Deck
FM 2Y6A7.AM	SM	X-EDN-19, X-EDNK-22	USA	Metal Deck
FM 3021719	SM	X-ENP-19	USA	Metal Deck

Approval	Segment	Product	Country	Application
FM 3026695	ME	X-EW6H, X-EW10H	USA	Fastenings to steel
FM 3029102	SM	X-ENP-19, X-EDN-19, X-EDNK22	USA	Form deck - LWC
FM 3031301	ME	X-HS W6/10 U19	USA	Sprinkler
FM 3036326	SM	X-ENP-19, X-EDN-19, X-EDNK22	USA	Metal Deck
FM 3048232	SM	X-ENP-19, X-EDN-19, X-EDNK22, X-HSN 24	USA	Metal Deck
GL 12272-10HH	PS	X-BT	Int.	Fastenings to steel
IBMB 2006/2011	IF	X-U	D	Fire Rating
IBMB 3041/8171	IF	DX-Kwik, X-CR, X-DKH, X-M6H, X-M8H	D	Fire Rating
IBMB 8998/2008	IF	X-GN, X-GHP, X-DW	D	Fire Rating
IBMB P-1433/1043-MPA BS	ME	DX-Kwik X-HS	D	Ceiling Hanger
ICC-ES ESR-1116	SM	X-EDN-19, X-EDNK22, X-ENP19, Co-Listing in Wheeling ESR	USA	Metal Deck
ICC-ES ESR-1169	SM	X-ENP-19, Co-Listing in CSI ESR	USA	Metal Deck
ICC-ES ESR-1414	SM	X-EDN-19, X-EDNK22, ENPH2, Co-Listing in ASC ESR	USA	Metal Deck
ICC-ES ESR-1663*	BC	EDS, DS, X-C, X-CR, X-ALH, W6, W10	USA	Fastenings to steel and concrete
ICC-ES ESR-1735P	SM	X-EDN-19, X-EDNK22, Co-listing in Vercor ESR	USA	Metal Deck
ICC-ES ESR-1752*	IF	X-GN, X-GHP, X-EGN, X-S, X-C, X-C20THP, X-C22P8TH, X-DW	USA	Dry-wall
ICC-ES ESR-2184*	IF	X-CC27 C27/32, U22/27, ALH22/27	USA	Ceiling Hanger
ICC-ES ESR-2197	SM	X-ENP-19, X-EDN-19, X-EDNK22	USA	Metal Deck
ICC-ES ESR-2269	BC	X-U, X-U15	USA	Fastenings to steel and concrete
ICC-ES ESR-2347*	ME	X-EW6H, X-EW10H; X-CRM, X-BT	USA	Stud connections to steel
ICC-ES ESR-2379	BC	X-DNI72, X-ZF72, X-CF72, X-CP72, X-CR-L72	USA	Sill Plate
ICC-ES ESR-2776*	SM	X-ENP-19, X-EDN-19, X-EDNK22	USA	Metal Deck
ICC-ES ESR-2795*	ME	X-HS U19/27/32	USA	Ceiling hanger
ICC-ES ESR-2892*	IF	X-CW	USA	Ceiling hanger
ICC-ES ESR-3059	IF	X-GPN	USA	Plywood
LR 03/00070	PS	X-BT	Int.	Fastenings to steel
LR 97/00077	PS	X-U, EDS, DS, X-ENP-19, X-ENP2K, X-EDN, X-EDNK, X-EM, X-EW, X-EF, X-HS, X-CC, X-FCM, X-FCP	Int.	Fastenings to steel
LR 97/00078	PS	X-CR, X-CRM, X-FCM-R, X-FCP-R, X-HS-R	Int.	Fastenings to steel
MLIT / BCJ	SM	X-HVB	Jap	Shear Connection
MLIT 2005	SM	X-ENP-19	Jap	Composite Deck
Rom.Ministry_AT 016-01/281-2013	SM	X-HVB	Rom	Shear Connection
Russian Maritime Register	PS	X-BT	Int.	Fastenings to steel, Shipbuilding
SDI	SM	X-ENP-19	USA	Fastenings to steel
SDI	SM	X-HSN 24, X-EDN19, X-EDNK22	USA	Fastenings to steel
Socotec PX 0091/7	SM	X-HVB	F	Shear Connection
Socotec PX 0091/8	SM	X-HVB	F	Shear Connection - Rehabilitation

Approval	Segment	Product	Country	Application
Socotec TX 8710	SM	NPH2	F	Metal Deck
Socotec WX 1509	IF	DNH37, X-CC DKH48, X-HS DKH48, M8H	F	Fastenings to concrete
Socotec WX 1530	BC	X-IE	F	Insulation
TZUS 070-041312	SM	X-HVB	Cz	Shear Connection
U.S. Navy 61/09-220	PS	X-BT for LPD-17	USA	Fastening to steel
UL E 257069	ME	X-BT-M6/W6, X-BT-M/W10-SN12-R	USA/Can	Grounding
UL E201485	ME	X-ECH/FR-L/-M/-S DNI-H42 PH or X-U, X-EKB, X-ECT	USA/Can	Electrical fastenings
UL E217969	ME	X-HS W6/10 U19/22/27, X-RH	USA/Can	Mechanical fastenings
UL EX 2258	ME	W10, EW10, X-EW6H, X-EW10H	USA/Can	Sprinkler
UL R 13203	SM	X-EDN-19, X-EDNK-22, X-ENP-19	USA	Metal Deck

Nails → Approvals

Product	Segment	Approval	Country	Application
DNH37	IF	Socotec WX 1509	F	Fastenings to concrete
DS	BC	COLA RR 25646	USA	Fastenings to steel and concrete
	BC	ICC-ES ESR-1663*	USA	Fastenings to steel and concrete
	PS	LR 97/00077	Int.	Fastenings to steel
	IF	IBMB 3041/8171	D	Fire Rating
DX-Kwik	IF	IBMB 3041/8171	D	Fire Rating
EDS	PS	ABS 01-HS156800A/3-PDA	Int.	Fastenings to steel
	BC	COLA RR 25646	USA	Fastenings to steel and concrete
	BC	ICC-ES ESR-1663*	USA	Fastenings to steel and concrete
	PS	LR 97/00077	Int.	Fastenings to steel
ENPH2	SM	ICC-ES ESR-1414	USA	Metal Deck
ESD	BC	COLA RR 25646	USA	Fastenings to steel and concrete
EW6	BC	COLA RR 25646	USA	Fastenings to steel and concrete
EW10	BC	COLA RR 25646	USA	Fastenings to steel and concrete
	ME	FM	USA	Sprinkler
	ME	UL EX 2258	USA/Can	Sprinkler
M8H	IF	DIBt Z-21.7-670	D	Ceiling Hanger
	IF	Socotec WX 1509	F	Fastenings to concrete
NPH2	SM	BUTgb ATG 13/1824	B	Metal Deck
	SM	Socotec TX 8710	F	Metal Deck
W6	BC	COLA RR 25646	USA	Fastenings to steel and concrete
	BC	ICC-ES ESR-1663*	USA	Fastenings to steel and concrete
W10	BC	COLA RR 25646	USA	Fastenings to steel and concrete
	BC	ICC-ES ESR-1663*	USA	Fastenings to steel and concrete
	ME	UL EX 2258	USA/Can	Sprinkler
	ME	FM	USA	Sprinkler
Wood nails		BRANZ Appraisal 780 (2012)	NZ	Timber joints
X-ALH	BC	COLA RR 25646	USA	Fastenings to steel and concrete
	BC	ICC-ES ESR-1663*	USA	Fastenings to steel and concrete
X-BT	PS	ABS 03-HS 369456/3-PDA	Int.	Fastenings to steel, Off-Shore, Shipbuilding
	PS	BV 23498/A1	Int.	Fastenings to steel, Shipbuilding
	PS	Canadian Navy	Can	Fastenings to steel, Shipbuilding
	PS	DNV	Int.	Fastenings to steel, Grating
X-BT	PS	GL 12272-10HH	Int.	Fastenings to steel

Product	Segment	Approval	Country	Application
	ME	ICC-ES ESR-2347*	USA	Stud connections to steel
	PS	LR 03/00070	Int.	Fastenings to steel
	ME	COLA RR 25684	USA	Fastenings to steel
X-BT	PS	Russian Maritime Register	Int.	Fastening to steel, shipbuilding
X-BT for LPD-17	PS	U.S. Navy 61/09-220	USA	Fastening to steel
X-BT-M/W10-SN12-R	ME	UL E 257069	USA/Can	Grounding
X-BT-M6/W6	ME	UL E 257069	USA/Can	Grounding
X-C	BC	COLA RR 25646	USA	Fastenings to steel and concrete
	BC	ICC-ES ESR-1663*	USA	Fastenings to steel and concrete
	IF	ICC-ES ESR-1752*	USA	Dry-wall
X-C20THP	IF	ICC-ES ESR-1752*	USA	Dry-wall
X-C22P8TH	IF	ICC-ES ESR-1752*	USA	Dry-wall
X-CC	ME	CSTB AT 3/09-639	F	Electrical fastenings
	PS	LR 97/00077	Int.	Fastenings to steel
X-CC DKH48	IF	Socotec WX 1509	F	Fastenings to concrete
X-CC27 ALH22/27	IF	COLA RR 25651	USA	Ceiling Hanger
	IF	ICC-ES ESR-2184*	USA	Ceiling Hanger
X-CC27 C27/32	IF	COLA RR 25651	USA	Ceiling Hanger
	IF	ICC-ES ESR-2184*	USA	Ceiling Hanger
X-CC27 U22/27	IF	COLA RR 25651	USA	Ceiling Hanger
	IF	ICC-ES ESR-2184*	USA	Ceiling Hanger
X-CF72	BC	COLA RR 25708	USA	Sill plate
	BC	ICC-ES ESR-2379	USA	Sill Plate
X-CP72	BC	COLA RR 25708	USA	Sill plate
	BC	ICC-ES ESR-2379	USA	Sill Plate
X-CR	PS	ABS 01-HS156800B/2-PDA	Int.	Fastenings to steel
	BC	COLA RR 25646	USA	Fastenings to steel and concrete
	IF	IBMB 3041/8171	D	Fire Rating
	BC	ICC-ES ESR-1663*	USA	Fastenings to steel and concrete
	PS	LR 97/00078	Int.	Fastenings to steel
X-CR M	PS	ABS 01-HS156800B/2-PDA	Int.	Fastenings to steel
	ME	ICC-ES ESR-2347*	USA	Stud connections to steel
	PS	LR 97/00078	Int.	Fastenings to steel
X-CR M8	ME	COLA RR 25684	USA	Fastenings to steel
	SM	DIBt Z-21.7-1512	D	Facade
	IF	DIBt Z-21.7-670	D	Ceiling Hanger
X-CR 14	SM	DIBt Z-14.4-456	D	Glas facade
X-CR 48 (DX-Kwik)	SM	DIBt Z-21.7-1512	D	Facade
	IF	DIBt Z-21.7-670	D	Ceiling Hanger
X-CR-L72	BC	COLA RR 25708	USA	Sill plate
	BC	ICC-ES ESR-2379	USA	Sill Plate
X-CRW	PS	ABS 01-HS156800B/2-PDA	Int.	Fastenings to steel
X-CW	IF	COLA RR 25839	USA	Ceiling hanger

Product	Segment	Approval	Country	Application
X-CW	IF	ICC-ES ESR-2892*	USA	Ceiling hanger
X-DAK	IF	COLA RR 25662	USA	Dry-wall
X-DKH	IF	IBMB 3041/8171	D	Fire Rating
X-DKH48	IF	DIBt Z-21.7-670	D	Ceiling Hanger
X-DNI	BC	COLA RR 25646	USA	Fastenings to steel and concrete
X-DNI72	BC	COLA RR 25708	USA	Sill plate
	BC	ICC-ES ESR-2379	USA	Sill Plate
X-DW	IF	COLA RR 25662	USA	Dry-wall
	IF	IBMB 8998/2008	D	Fire Rating
	IF	ICC-ES ESR-1752*	USA	Dry-wall
X-ECH	ME	CSTB AT 3/09-639	F	Electrical fastenings
X-ECH/FR-L/-M/-S DNI-H42 PH or X-U	ME	UL E201485	USA/Can	Electrical fastenings
	ME	UL E201485	USA/Can	Electrical fastenings
X-ECT	ME	CSTB AT 3/09-639	F	Electrical fastenings
	ME	UL E201485	USA/Can	Electrical fastenings
X-EDN	PS	ABS 01-HS156800A/3-PDA	Int.	Fastenings to steel
	PS	LR 97/00077	Int.	Fastenings to steel
X-EDN19	SM	COLA RR 25296	USA	Metal Deck
	SM	COLA RR 25877	USA	Metal Deck
	SM	SDI	USA	Fastening to steel
	DM	FM 3049232	USA	Metal Deck
	SM	FM 3029102	USA	Form deck - LWC
	SM	FM 3036326	USA	Metal Deck
	SM	ICC-ES ESR-1116	USA	Metal Deck
	SM	ICC-ES ESR-1414	USA	Metal Deck
	SM	ICC-ES ESR-1735P	USA	Metal Deck
	SM	ICC-ES ESR-2197	USA	Metal Deck
	SM	ICC-ES ESR-2776*	USA	Metal Deck
	SM	UL R 13203	USA	Metal Deck
	SM	FM 2Y6A7.AM	USA	Metal Deck
	SM	FM3049232	USA	Metal Deck
	SM	SDI	USA	Metal Deck
	SM	FM 0W8A6.AM	USA	Metal Deck
X-EDNI	BC	COLA RR 25646	USA	Fastenings to steel and concrete
X-EDNK	PS	ABS 01-HS156800A/3-PDA	Int.	Fastenings to steel
	PS	LR 97/00077	Int.	Fastenings to steel
X-EDNK22	SM	COLA RR 25296	USA	Metal Deck
	SM	COLA RR 25877	USA	Metal Deck
	SM	FM 3029102	USA	Form deck - LWC
	SM	FM 3036326	USA	Metal Deck
	SM	ICC-ES ESR-1116	USA	Metal Deck
	SM	ICC-ES ESR-1414	USA	Metal Deck
	SM	ICC-ES ESR-1735P	USA	Metal Deck
	SM	ICC-ES ESR-2197	USA	Metal Deck
	SM	ICC-ES ESR-2776*	USA	Metal Deck
	SM	UL R 13203	USA	Metal Deck
	SM	FM 2Y6A7.AM	USA	Metal Deck

Product	Segment	Approval	Country	Application	
	SM	FM 0W8A6.AM	USA	Metal Deck	
	SM	FM 3049232	USA	Metal Deck	
	SM	SDI	USA	Fastenings to steel	
X-EF	PS	ABS 01-HS156800A/3-PDA	Int.	Fastenings to steel	
	PS	LR 97/00077	Int.	Fastenings to steel	
X-EGN	IF	COLA RR 25662	USA	Dry-wall	
	IF	ICC-ES ESR-1752*	USA	Dry-wall	
X-EKB	ME	CSTB AT 3/09-639	F	Electrical fastenings	
	ME	UL E201485	USA/Can	Electrical fastenings	
X-EKS	ME	CSTB AT 3/09-639	F	Electrical fastenings	
X-EKSC	ME	CSTB AT 3/09-639	F	Electrical fastenings	
X-EM	PS	ABS 01-HS156800A/3-PDA	Int.	Fastenings to steel	
	PS	LR 97/00077	Int.	Fastenings to steel	
X-ENP	SM	COLA RR 25296	USA	Metal Deck	
X-ENP19	SM	ICC-ES ESR-1116	USA	Metal Deck	
	PS	ABS 01-HS156800A/3-PDA	Int.	Fastenings to steel	
	SM	COLA RR 25877	USA	Metal Deck	
	SM	ETA-04/0101-English	EEA	Metal Deck	
	SM	ETA-04/0101-French	EEA	Metal Deck	
	SM	ETA-04/0101-German	EEA	Metal Deck	
	SM	ETA-04/0101-Romanian	EEA	Metal Deck	
	SM	FM 3021719	USA	Metal Deck	
	SM	FM 3029102	USA	Form deck - LWC	
	SM	FM 3036326	USA	Metal Deck	
	SM	ICC-ES ESR-1169	USA	Metal Deck	
	SM	ICC-ES ESR-2197	USA	Metal Deck	
	SM	ICC-ES ESR-2776*	USA	Metal Deck	
	PS	LR 97/00077	Int.	Fastenings to steel	
	SM	MLIT 2005	Jap	Composite Deck	
	SM	UL R 13203	USA	Metal Deck	
	SM	FM 3049232	USA	Metal Deck	
	SM	SDI	USA	Fastenings to steel	
	X-ENP-19 Lateral buckling	SM	DIN EN 1993-1-3/NA	D	Metal Deck
	X-ENP2K	PS	ABS 01-HS156800A/3-PDA	Int.	Fastenings to steel
SM		BUTgb ATG 13/1825	B	Metal Deck	
SM		CSTB AT 5/03-1943	F	Metal Deck	
PS		LR 97/00077	Int.	Fastenings to steel	
X-EW	PS	ABS 01-HS156800A/3-PDA	Int.	Fastenings to steel	
	PS	LR 97/00077	Int.	Fastenings to steel	
X-EW6H	ME	COLA RR 25684	USA	Fastenings to steel	
	ME	FM 3026695	USA	Fastenings to steel	
	ME	ICC-ES ESR-2347*	USA	Stud connections to steel	
	ME	UL EX 2258	USA/Can	Sprinkler	
X-EW10H	ME	COLA RR 25684	USA	Fastenings to steel	

Product	Segment	Approval	Country	Application
	ME	ICC-ES ESR-2347*	USA	Stud connections to steel
	ME	UL EX 2258	USA/Can	Sprinkler
	ME	FM 3026695	USA	Fastenings to steel
X-FCM	PS	ABS 01-HS156800A/3-PDA	Int.	Fastenings to steel
	PS	LR 97/00077	Int.	Fastenings to steel
X-FCM-M	PS	ABS 01-HS156800B/2-PDA	Int.	Fastenings to steel
X-FCM-R	PS	ABS 01-HS156800B/2-PDA	Int.	Fastenings to steel
	PS	LR 97/00078	Int.	Fastenings to steel
	PS	ABS 03-HS 369456/3-PDA	Int.	Fastenings to steel, Off-Shore, Shipbuilding
X-FCM-R(M)	PS	BV 23498/A1	Int.	Fastenings to steel, Shipbuilding
	PS	DNV	Int.	Fastenings to steel, Grating
X-FCP	PS	LR 97/00077	Int.	Fastenings to steel
X-FCP-F	PS	ABS 01-HS156800B/2-PDA	Int.	Fastenings to steel
X-FCP-R	PS	ABS 01-HS156800B/2-PDA	Int.	Fastenings to steel
	PS	LR 97/00078	Int.	Fastenings to steel
X-GHP	IF	IBMB 8998/2008	D	Fire Rating
	IF	ICC-ES ESR-1752*	USA	Dry-wall
X-GN	IF	COLA RR 25662	USA	Dry-wall
	IF	IBMB 8998/2008	D	Fire Rating
	IF	ICC-ES ESR-1752*	USA	Dry-wall
X-GPN	IF	COLA RR 25921	USA	Plywood
	IF	ICC-ES ESR-3059	USA	Plywood
X-HS	ME	CSTB AT 3/09-639	F	Electrical fastenings
	PS	LR 97/00077	Int.	Fastenings to steel
X-HS (DX-Kwik)	ME	IBMB P-1433/1043-MPA BS	D	Ceiling Hanger
X-HS DKH48	IF	Socotec WX 1509	F	Fastenings to concrete
X-HS U19/27/32	ME	COLA RR 25826	USA	Ceiling hanger
	ME	ICC-ES ESR-2795*	USA	Ceiling hanger
X-HS W6/10 U19	ME	FM 3031301	USA	Sprinkler
X-HS W6/10 U19/22/27	ME	UL E217969	USA/Can	Mechanical fastenings
X-HSN 24	SM	FM 3049232	USA	Metal Deck
	SM	SDI	USA	Fastenings to steel
X-HS-R	PS	LR 97/00078	Int.	Fastenings to steel
X-HS-W	ME	CSTB AT 3/09-639	F	Electrical fastenings
X-HVB	SM	DIBt Z-26.4-46	D	Shear Connection
	SM	MLIT / BCJ	Jap	Shear Connection
	SM	Rom.Ministry_AT 016-01/214-2010	Rom	Shear Connection
	SM	Socotec PX 0091/7	F	Shear Connection
	SM	Socotec PX 0091/8	F	Shear Connection - Rehabilitation
	SM	TZUS 070-041312	Cz	Shear Connection
X-IE	BC	Socotec WX 1530	F	Insulation
XI-FV	BC	ETA-03/0004-English	EEA	ETICS
	BC	ETA-03/0004-German	EEA	ETICS
XI-FV	BC	ETA-03/0004-French	EEA	ETICS

Product	Segment	Approval	Country	Application
X-M6H	IF	IBMB 3041/8171	D	Fire Rating
X-M8H	IF	IBMB 3041/8171	D	Fire Rating
X-RH	ME	UL E217969	USA/Can	Mechanical fastenings
X-S	IF	COLA RR 25662	USA	Dry-wall
	IF	ICC-ES ESR-1752*	USA	Dry-wall
X-U	PS	ABS 01-HS156800A/3-PDA	Int.	Fastenings to steel
	BC	COLA RR 25675	USA	Fastenings to steel and concrete
	BC	DIBt Z-14.4-517	D	Fastenings to steel
	BC	ICC-ES ESR-2269	USA	Fastenings to steel and concrete
	PS	LR 97/00077	Int.	Fastenings to steel
	IF	IBMB 2006/2011	D	Fire Rating
X-U15	BC	COLA RR 25675	USA	Fastenings to steel and concrete
	BC	ICC-ES ESR-2269	USA	Fastenings to steel and concrete
X-ZF	IF	COLA RR 25662	USA	Dry-wall
X-ZF72	BC	COLA RR 25708	USA	Sill plate
	BC	ICC-ES ESR-2379	USA	Sill Plate

Alphabetical list of DX/GX fasteners

A-Z Fastener	Page	A-Z Fastener	Page
DNH	171	X-ET	265
DS	145	X-EW10H	181
EDS	151	X-EW6H	181
GX-WF	269	X-FB	257
M10	177	X-FCM	201
NPH	107	X-FCP	221
PDK2	95	X-FS	235
SDK2	95	X-GHP	139
W10	177	X-GN	139
X-BT	187	X-GR	209
X-C	129	X-HS	237
X-CC	237	X-HSN 24	103
X-CR	161	X-HS-W	247
X-CR for steel	157	X-HVB	111
X-CR M	195	X-IE	227
X-CT	167	X-M6	177
X-DFB	257	X-M6H	171
X-DKH	171	X-M8	177
X-ECC MX	243	X-M8H	171
X-ECH	251	X-MGR	217
X-ECT MX	261	X-PGR-RU	213
X-EDN19 THQ12	103	X-S	135
X-EDNK 22 THQ12	103	X-SW	231
X-EF7H	181	X-U	119
X-EGN	139	X-W6	177
X-EHS MX	243		
X-EKB	251		
X-EKS MX	261		
X-EM6H	181		
X-EM8H	181		
X-EM10H	181		
X-EMTC	261		
X-ENP	87		
X-ENP2K	97		

